



WE PROVIDE QUALITY

**DENTAL
INSTRUMENTS**

Table of Contents

<ul style="list-style-type: none"> Forceps 3 Extraction Forceps 38 Root Fragment Forceps Elevators 43 Root and Luxating Elevators Scalpels 75 Scalpel Handles and Blades Scissors 83 Micro Scissors 85 Surgical Scissors 108 Ligature Scissors 109 Wire and Plate Tweezers 113 Micro Forceps 118 Titanium Forceps 120 Dressing Forceps 121 Endo Forceps 122 Tissue Forceps 136 TC Forceps / Atraumatic 138 Membrane Drivers 141 Needle Holders Hemostats / Grasping Forceps 165 Towel Clamps 167 Sponge and Dressing Forceps 168 Hemostatic Forceps 174 Tissue Grasping Forceps Retractors 177 Retractors 188 Mouth Gags and Tongue Depressors 196 Mouth Props Implantology 199 Osteotomes and Chisels 203 Mallets 204 Periosteals 205 Trephines 	<ul style="list-style-type: none"> 206 Periosteals 207 Osteotomes 213 Trephines 214 Bone and Tissue Harvest Accessories 218 Measuring Instruments 220 Bone Holding Forceps Periosteals / Curettes / Bone 223 Periosteal Elevators 232 Curettes 238 Bone Files 240 Tissue Nippers 241 Bone Rongeurs 246 Bone Cutting Forceps Periodontics / Endodontics / Restoration 249 Periodontics 254 Endodontics 257 Diagnostic 261 Curettes and Scalers 269 Amalgam 271 Composite 274 Spatulas 275 Filling 281 Dental Restoration 285 Perio Chisels and Knives 288 Perio Probes and Explorers 291 Filling 302 Curettes and Scalers 308 Rubber-Dam Crown and Bridge 315 Crown and Bridge Instruments Useful Data & Maintenance 321 Conversion of Units 322 Cleaning, Maintenance & Sterilization 323 Maintenance Cycle & Tips Index 327 Alphanumeric Codes
---	--



• Forceps

3 | Dental Forceps

38 | Root Fragment Forceps



Zahnzangen, Englische Form
 Extracting Forceps, English Pattern
 Pinze per estrazione, Forma Inglese
 Pinzas da extracción, Forma Inglesa
 Daviers, Forme Anglaise

Extraction Forceps

FORCEPS

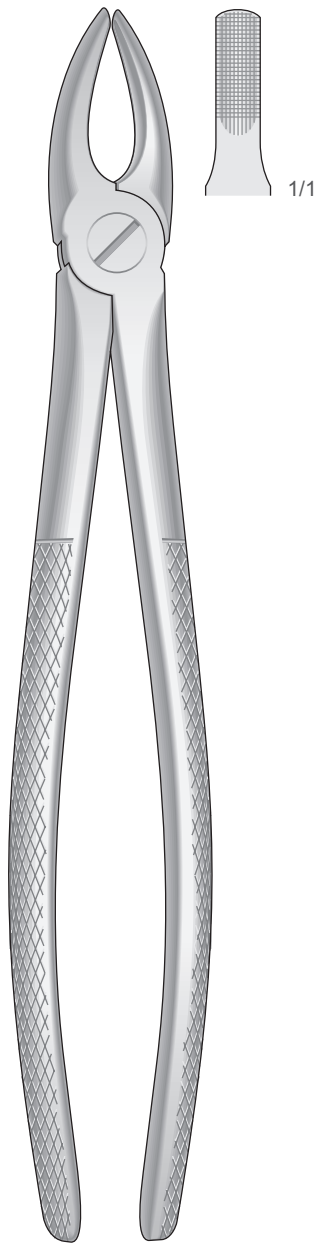

1
 Fig. 1

Obere Schneide- und Eckzähne
 Upper Incisors and cuspids
 Incisivi e canini superiori
 Incisivos y caninos superiores
 Incisives et canines supérieures

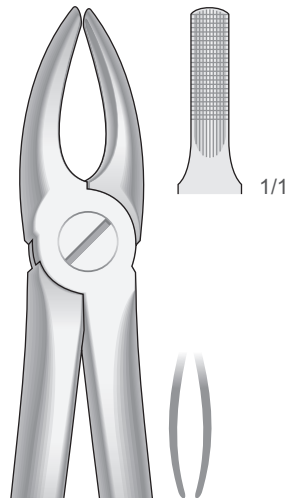

2
 Fig. 2

Obere Schneide- und Eckzähne
 Upper Incisors and cuspids
 Incisivi e canini superiori
 Incisivos y caninos superiores
 Incisives et canines supérieures

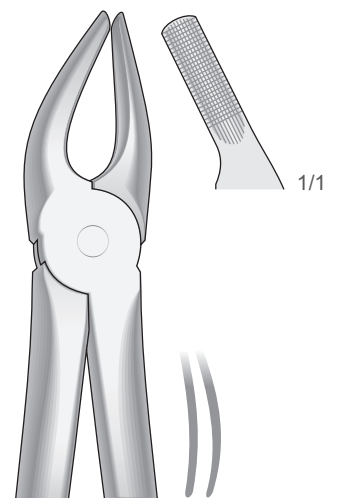

7
 Fig. 7

Obere Prämolaren
 Upper premolars
 Premolari superiori
 Premolares superiores
 Prémolaires supérieures

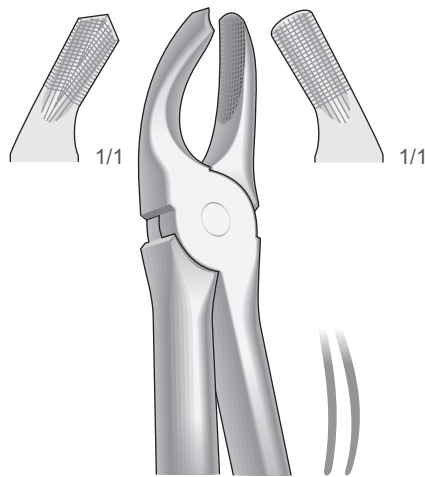

17
 Fig. 17

Obere Molaren, rechts
 Upper molars, right
 Molari superiori, destra
 Molares superiores, derechos
 Molaires supérieures, droites

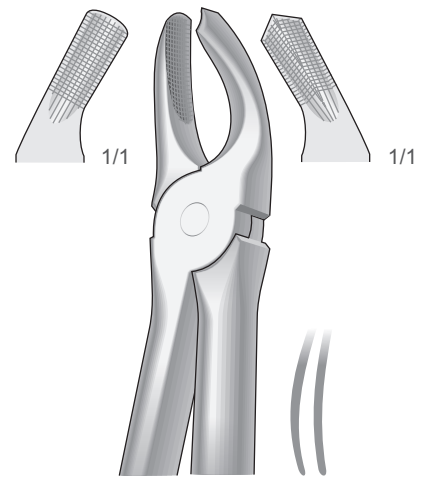

18
 Fig. 18

Obere Molaren, links
 Upper molars, left
 Molari superiori, sinistra
 Molares superiores, izquierdos
 Molaires supérieures, gauches

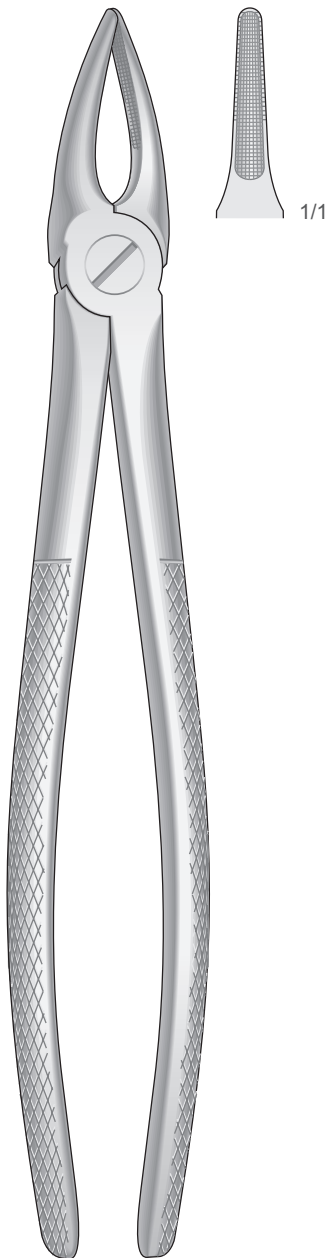

29

Fig. 29

Obere Wurzeln und Schneidezähne
 Upper Roots and incisors
 Radici e incisivi superiori
 Raíces y incisivos superiores
 Racines et incisives supérieures

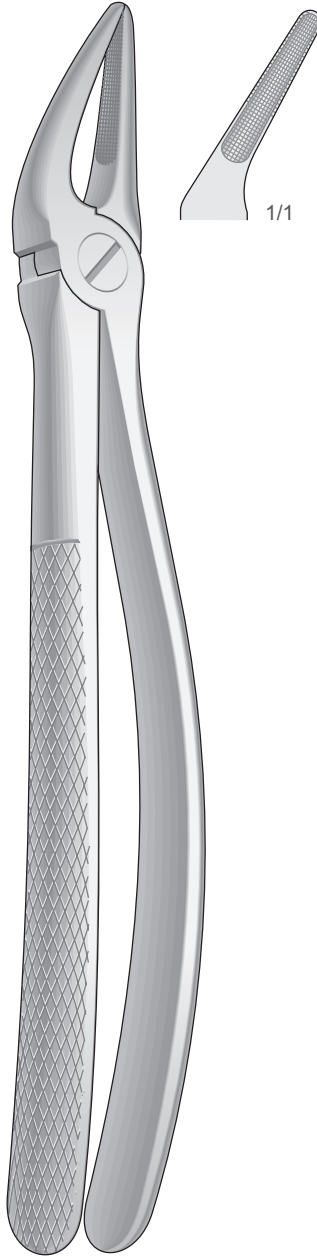

30

Fig. 30

Obere Wurzeln
 Upper Roots
 Radici superiori
 Raíces superiores
 Racines supérieures

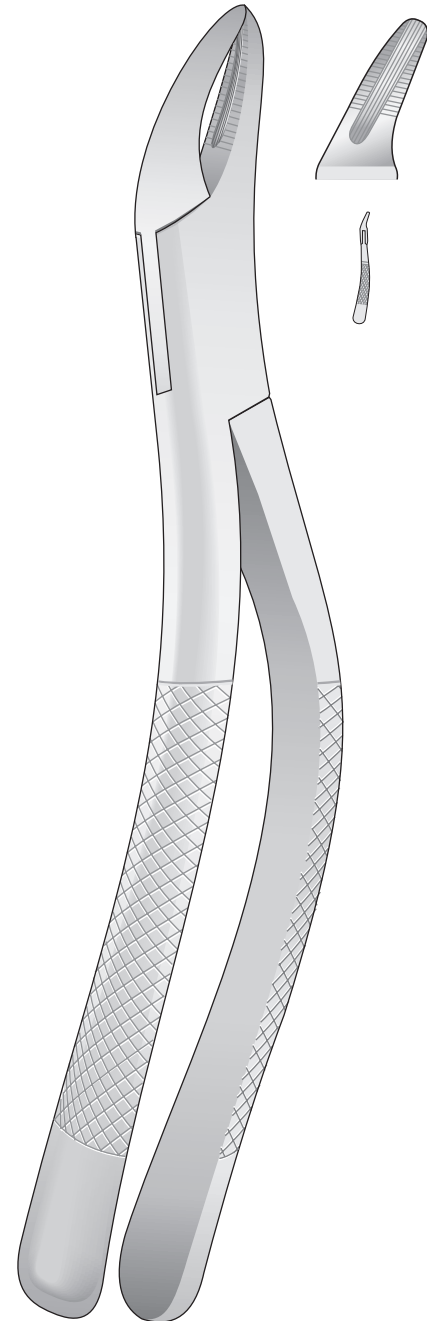

76S

Fig. 76

Obere Schneidezähne, Prämolaren, Wurzeln
 Upper incisors, premolars, roots
 Incisivi, premolari e radici superiori
 Incisivos, premolares y raíces superiores
 Incisives, prémolaires et racines supérieures

Zahnzangen, Englische Form
 Extracting Forceps, English Pattern
 Pinze per estrazione, Forma Inglese
 Pinzas da extracción, Forma Inglesa
 Daviers, Forme Anglaise

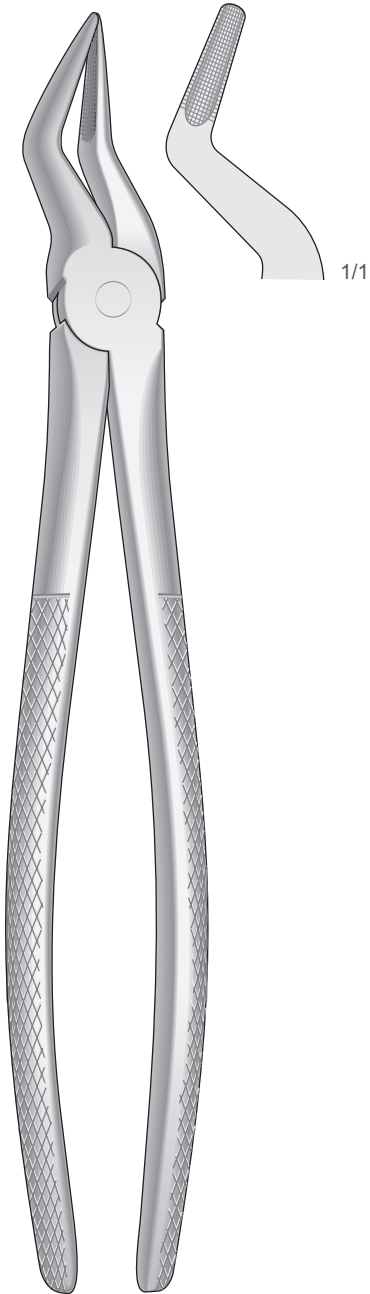

51
 Fig. 51
 Obere Wurzeln
 Upper Roots
 Radici superiori
 Raíces superiores
 Racines supérieures

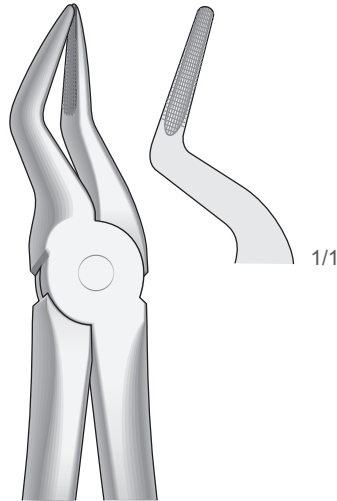

51A
 Fig. 51A
 Obere Wurzeln
 Upper Roots
 Radici superiori
 Raíces superiores
 Racines supérieures

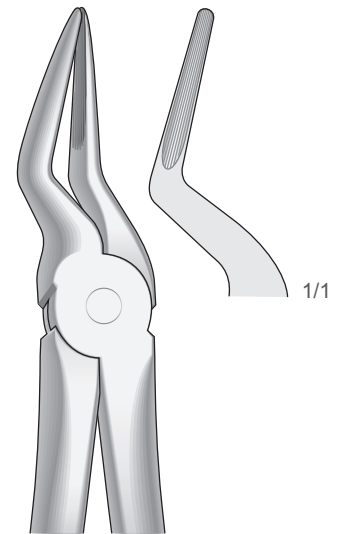

51L
 Fig. 51AL
 Obere Wurzeln
 Upper Roots
 Radici superiori
 Raíces superiores
 Racines supérieures

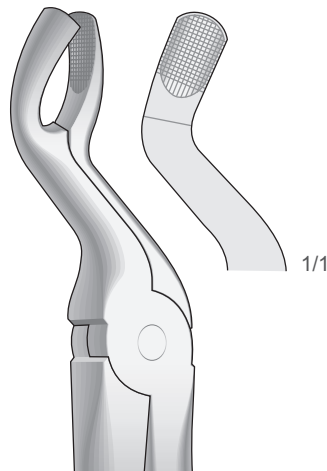

67A
 Fig. 67A
 Obere Dritte Molaren - Für Obere Weisheitszähne
 Upper molars - For Upper wisdom teeth
 Ottavi superiori - Per denti del giudizio superiori
 Molares superiores - Para muelas del juicio superiores
 Molaires supérieures - Pour dents de sagesse supérieures

Zahnzangen, Englische Form
 Extracting Forceps, English Pattern
 Pinze per estrazione, Forma Inglese
 Pinzas da extracción, Forma Inglesa
 Daviers, Forme Anglaise

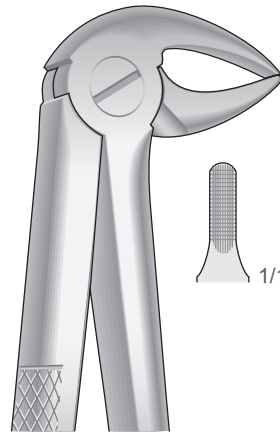

33
 Fig. 33

Untere Prämolaren, Schneidezähne und Wurzeln
 Lower incisors, premolars and roots
 Incisivi, premolari e radici inferiori
 Incisivos, premolares y raíces inferiores
 Incisives, prémolaires et racines inférieures

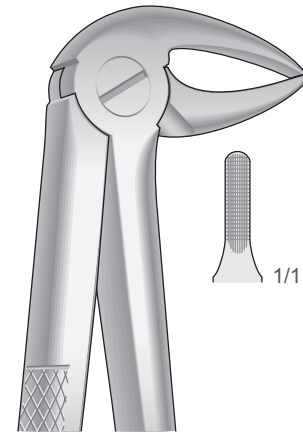

33A
 Fig. 33A

Untere Wurzeln, schlankes Maul
 Lower roots, Slender jaw
 Radici inferiori, morso stretto
 Raíces inferiores, boca estrecha
 Racines inférieures, avec un bec très fin

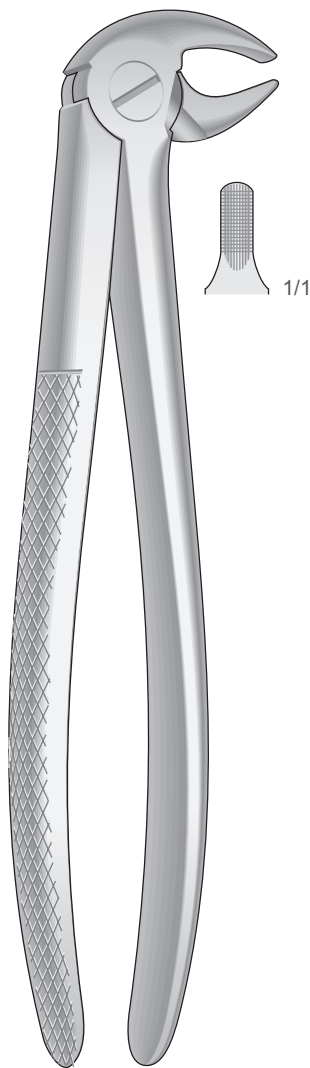

13
 Fig. 13

Untere Eckzähne und Prämolaren
 Lower cuspids and premolars
 Canini e premolari inferiori
 Caninos y premolares inferiores
 Canines et prémolaires inférieures

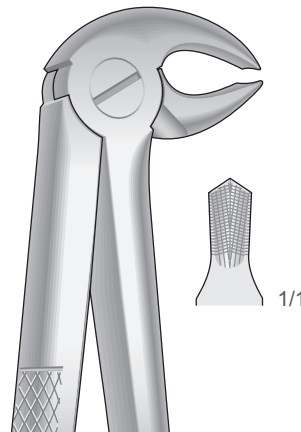

22
 Fig. 22

Untere Molaren
 Lower molars
 Molari inferiori
 Molares inferiores
 Molaires inférieures

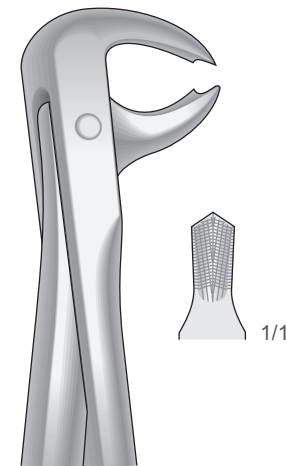

73
 Fig. 73

Untere Molaren
 Lower molars
 Molari inferiori
 Molares inferiores
 Molaires inférieures

Zahnzangen, Englische Form
 Extracting Forceps, English Pattern
 Pinze per estrazione, Forma Inglese
 Pinzas da extracción, Forma Inglesa
 Daviers, Forme Anglaise

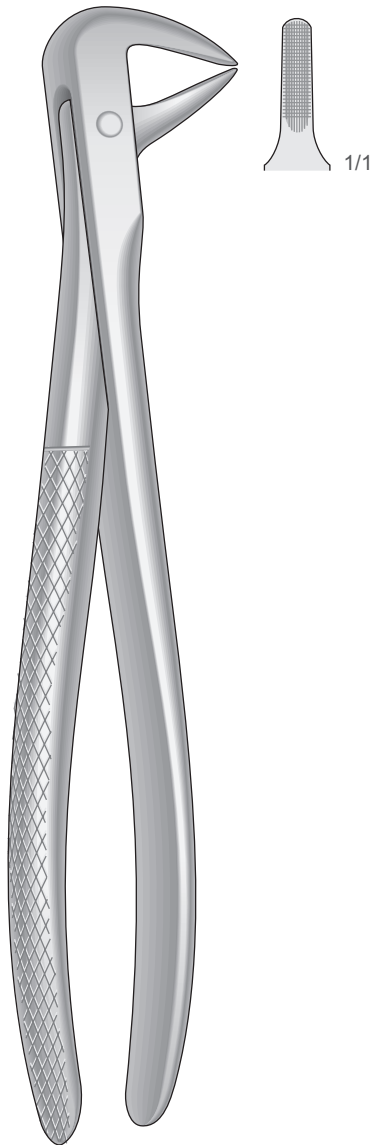

74
 Fig. 74
 Untere Wurzeln
 Lower roots
 Radici inferiori
 Raíces inferiores
 Racines inférieures

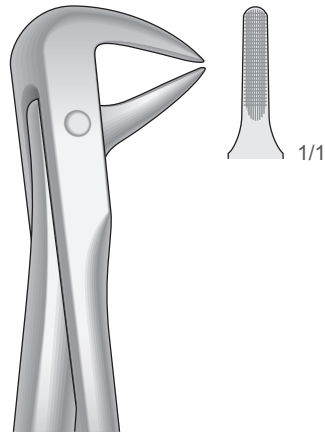

74N
 Fig. 74N

Untere Wurzeln, schneide-und Eckzähne
 Lower roots, Incisors and bicusps
 Radici, incisivi e canini inferiori
 Raíces, incisivos y caninos inferiores
 Racines, incisives et canines inférieures

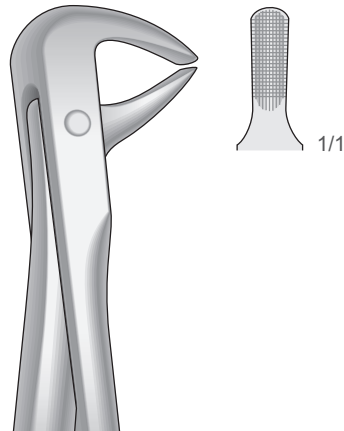

75
 Fig. 75

Untere Eckzähne und Prämolaren
 Lower Cuspids and bicusps
 Canini e premolari inferiori
 Caninos y premolares inferiores
 Canines et prémolaires inférieures

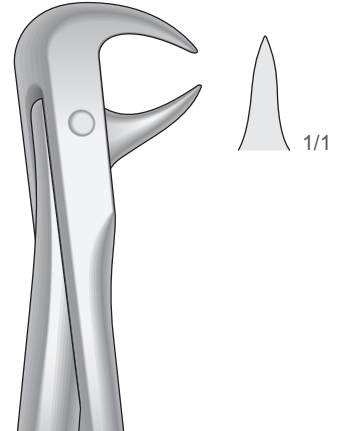

86A
 Fig. 86A

Untere Molaren
 Lower molars
 Molari inferiori
 Molares inferiores
 Molaires inférieures



4
 Fig. 4

Untere Schneide- und Eckzähne
 Lower Incisors and cuspids
 Incisivi e canini inferiori
 Incisivos y caninos inferiores
 Incisives et canines inférieures

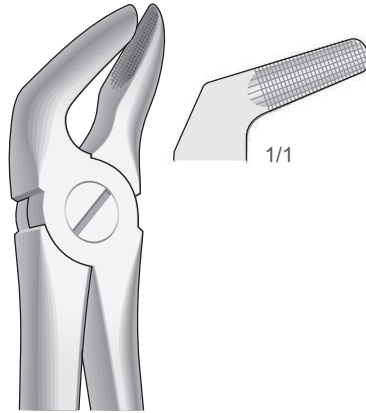

8
 Fig. 8

Untere Prämolaren
 Lower premolars
 Premolari inferiori
 Premolares inferiores
 Prémolaires inférieures

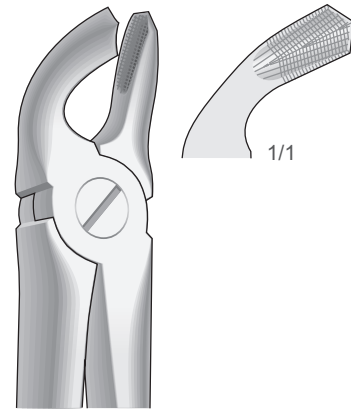

21
 Fig. 21

Untere Weisheitszähne und Molaren
 Lower wisdom teeth and molars
 Denti del giudizio e molari inferiori
 Muelas del juicio y Molares inferiores
 Dents de sagesse et molaires inférieures

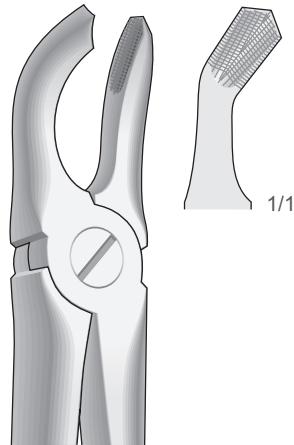

79
 Fig. 79

Untere Weisheitszähne
 Lower wisdom teeth
 Denti del giudizio inferiori
 Muelas del juicio inferiores
 Dent de sagesse inférieures

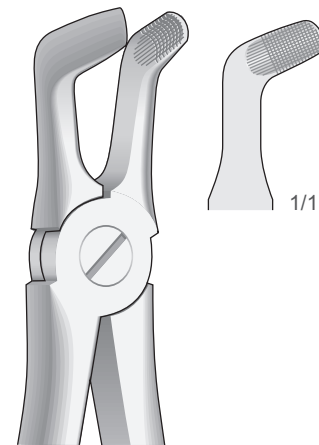

79A
 Fig. 79A

Untere Molaren und Weisheitszähne
 Lower molars and wisdom teeth
 Molari e denti del giudizio inferiori
 Molares y muelas del juicio inferiores
 Molaires et dent de sagesse inférieures

Zahnzangen, Englische Form
 Extracting Forceps, English Pattern
 Pinze per estrazione, Forma Inglese
 Pinzas da extracción, Forma Inglesa
 Daviers, Forme Anglaise

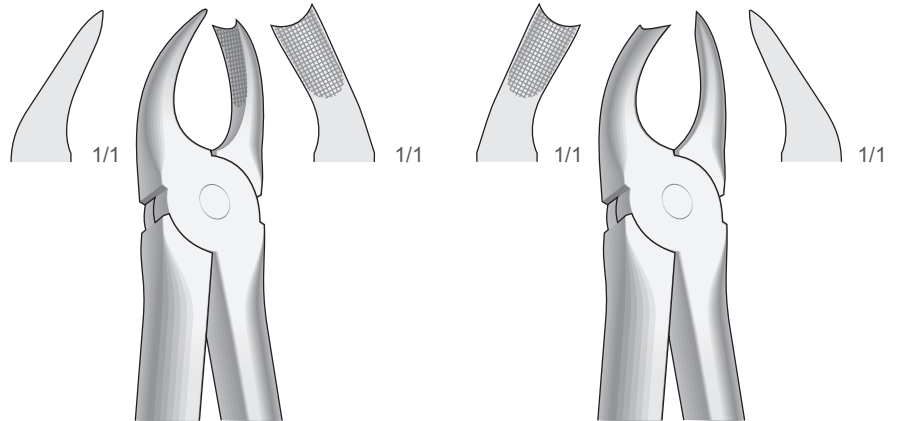

89
 Fig. 89

Obere Molaren, rechts
 Upper molars, right
 Molari superiori, destra
 Molares superiores, derechos
 Molaires supérieures, droites

90
 Fig. 90

Obere Molaren, links
 Upper molars, left
 Molari superiori, sinistra
 Molares superiores, izquierdos
 Molaires supérieures, gauches

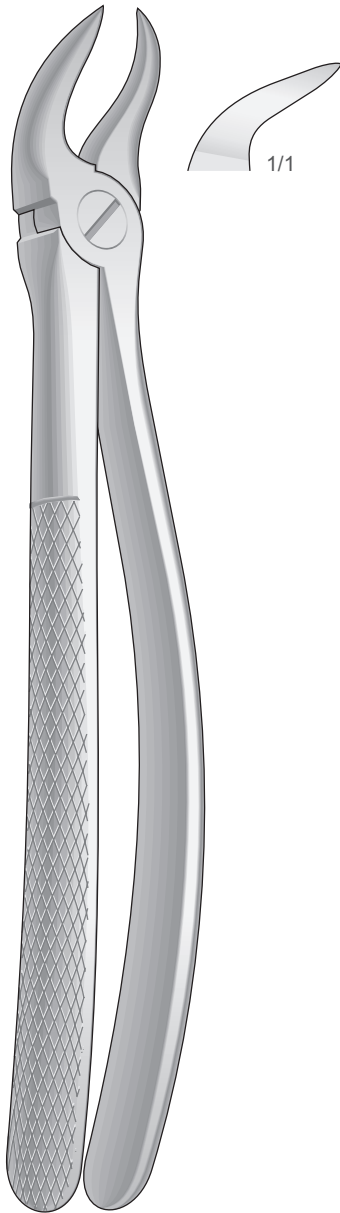

87
 Fig. 87
 Untere Molaren
 Lower molars
 Molari inferiori
 Molares inferiores
 Molaires inférieures

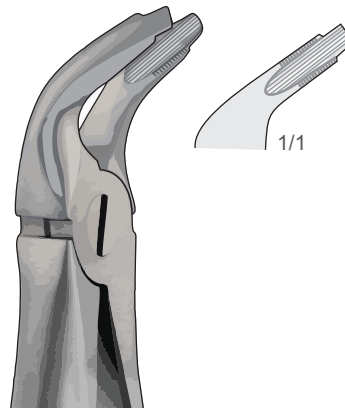

AM-451
 Fig. 451
 Deep Grip

Untere Wurzeln, schneide-und Eckzähne
 Lower roots, incisors and bicuspid
 Radici, incisivi e canini inferiori
 Raíces, incisivos y caninos inferiores
 Racines, incisives et canines inférieures

Zahnzangen, Englische Form
 Extracting Forceps, English Pattern
 Pinze per estrazione, Forma Inglese
 Pinzas da extracción, Forma Inglesa
 Daviers, Forme Anglaise

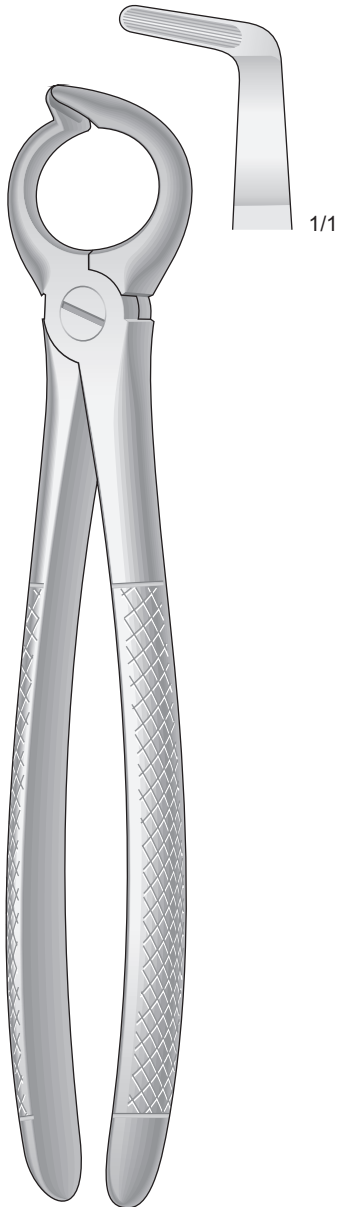

68
 Fig. 68
 Untere Wurzeln
 Lower Roots
 Radici inferiori
 Raíces inferiores
 Racines inférieures

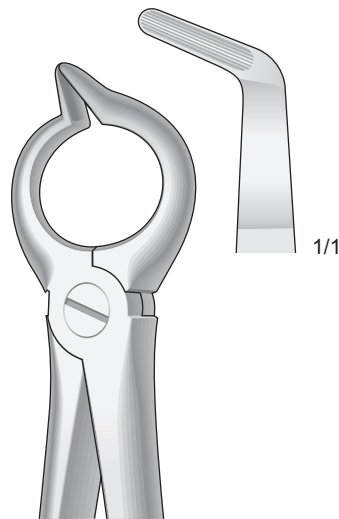

68A
 Fig. 68A
 Untere Wurzeln
 Lower Roots
 Radici inferiori
 Raíces inferiores
 Racines inférieures

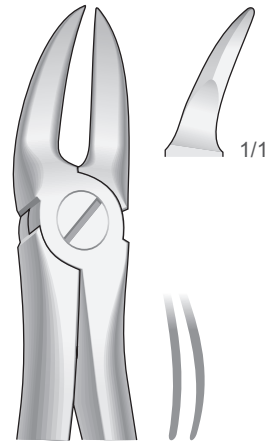

55
 Fig. 55

Zum Trennen oberer Molarenwurzeln
 For separating upper molar roots
 Per radici dei molari superiori, presa in profondità
 Para partir raíces de molares superiores, profundo
 Pour séparer les racines des molaires supérieures

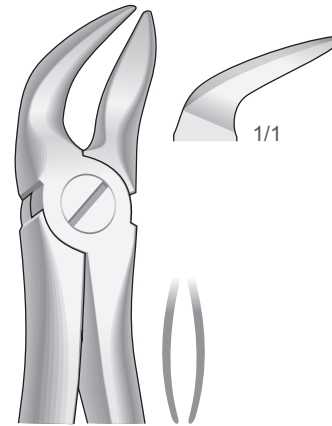

56
 Fig. 56

Zum Trennen Unterer Molarenwurzeln
 For separating lower molar roots
 Per radici dei molari inferiori, presa in profondità
 Para partir raíces de molares inferiores, profundo
 Pour séparer les racines des molaires inférieures

Zahnzangen, Englische Form
 Extracting Forceps, English Pattern
 Pinze per estrazione, Forma Inglese
 Pinzas da extracción, Forma Inglesa
 Daviers, Forme Anglaise

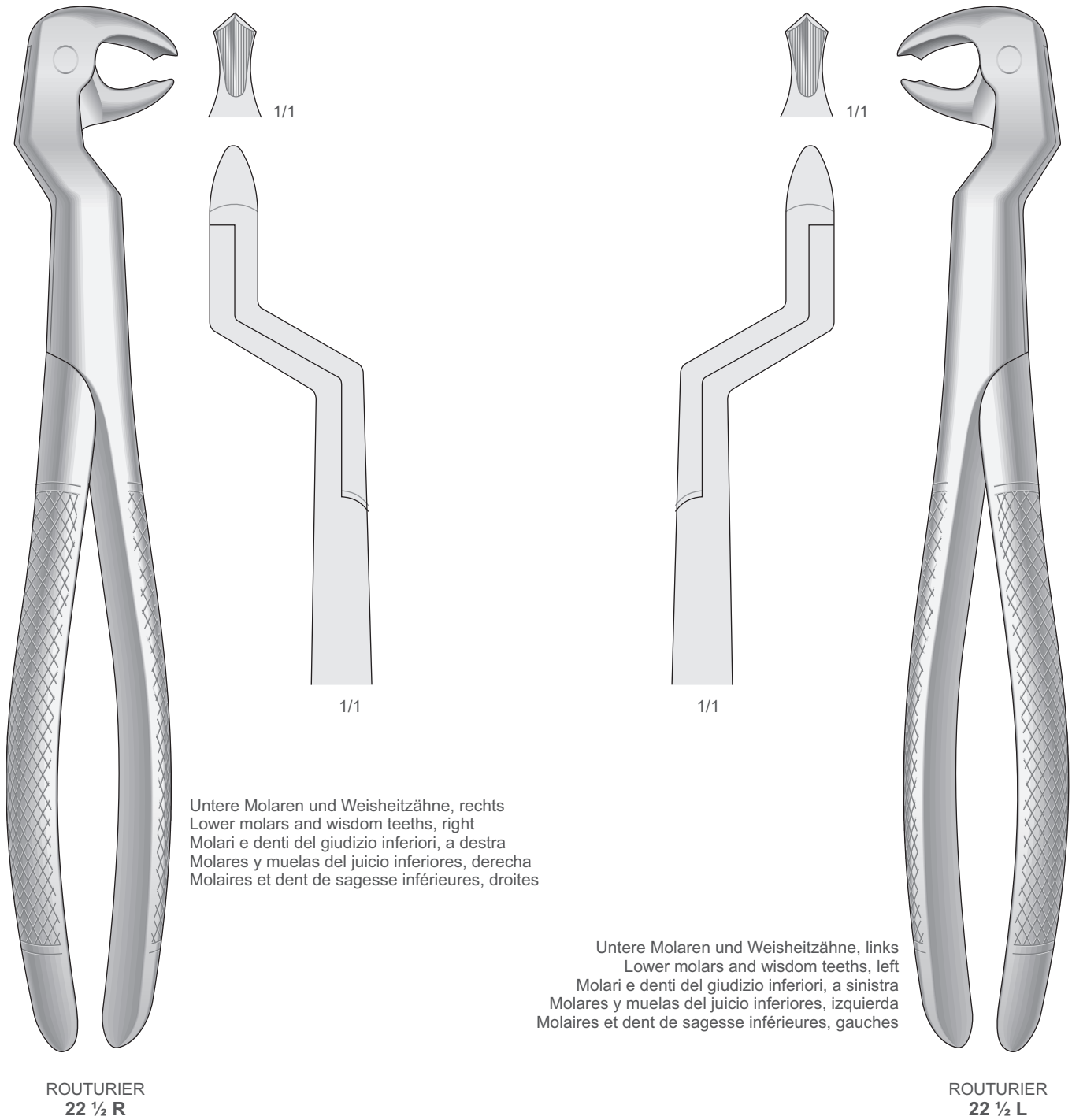

Untere Molaren und Weisheitszähne, rechts
 Lower molars and wisdom teeth, right
 Molari e denti del giudizio inferiori, a destra
 Molares y muelas del juicio inferiores, derecha
 Molaire et dent de sagesse inférieures, droites

Untere Molaren und Weisheitszähne, links
 Lower molars and wisdom teeth, left
 Molari e denti del giudizio inferiori, a sinistra
 Molares y muelas del juicio inferiores, izquierda
 Molaire et dent de sagesse inférieures, gauches

ROUTURIER
 22 1/2 R

ROUTURIER
 22 1/2 L

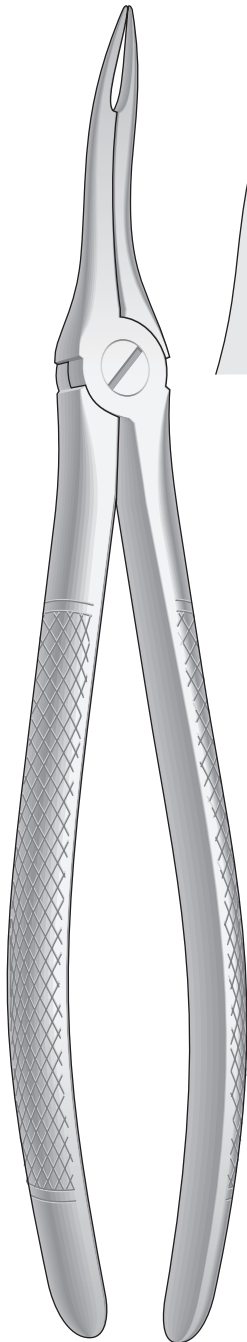

49
 Fig. 49

Obere Wurzeln sehr feine
 Upper very fine roots
 Radici superiori molto sottili
 Raíces superiores muy finas
 Racines supérieures très fines

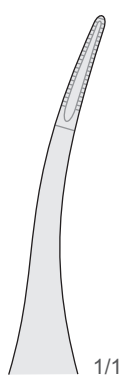

1/1



1/1

48
 Fig. 48 - 44

Obere Wurzeln
 Upper roots
 Radici superiori
 Raíces superiores
 Racines supérieures

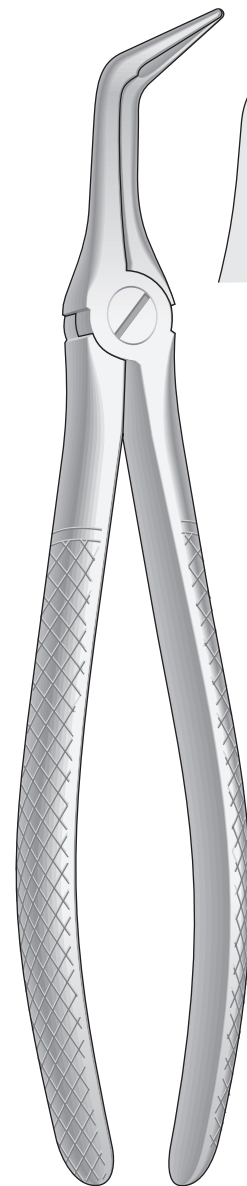

46L
 Fig. 46L

Untere Wurzeln
 Lower roots
 Radici inferiori
 Raíces inferiores
 Racines inférieures

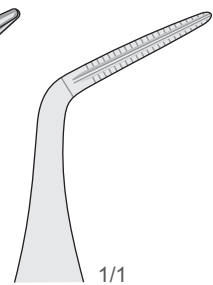

1/1

Zahnzangen, Paßformgriff
 Extracting Forceps, Anatomical Handle
 Pinze per estrazione, Manico anatomico
 Pinzas da extracción, Mango anatómico
 Daviers, Manche anatomique

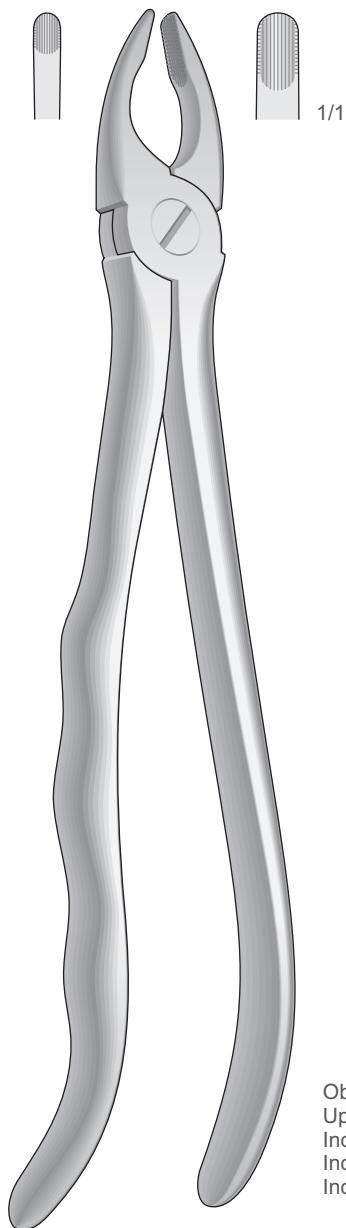

S-3AN
 Fig. 3

Obere Schneide- und Eckzähne
 Upper incisors and cuspids
 Incisivi e canini superiori
 Incisivos y caninos superiores
 Incisives et canines supérieures

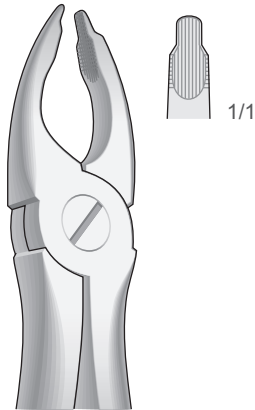

S-34
 Fig. 34

Obere Schneide- und Eckzähne
 Upper incisors and cuspids
 Incisivi e canini superiori
 Incisivos y caninos superiores
 Incisives et canines supérieures

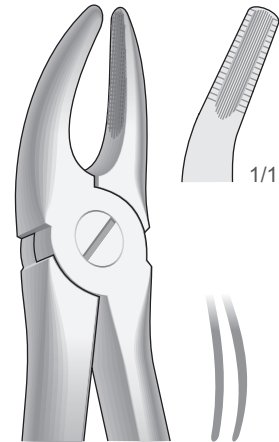

S-7
 Fig. 7

Obere Prämolaren
 Upper premolars
 Premolari superiori
 Premolares superiores
 Prémolaires supérieures

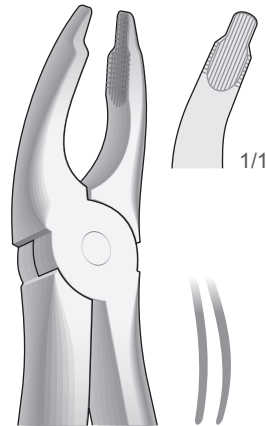

S-35
 Fig. 35

Obere Schneidezähne und Prämolaren, tiefgreifend
 Upper incisors and bicuspid, deep-gripping
 Incisivi e premolari superiori, presa in profondità
 Incisivos y premolares superiores, a gran calado
 Incisives et prémolaires supérieures, à attaque profonde

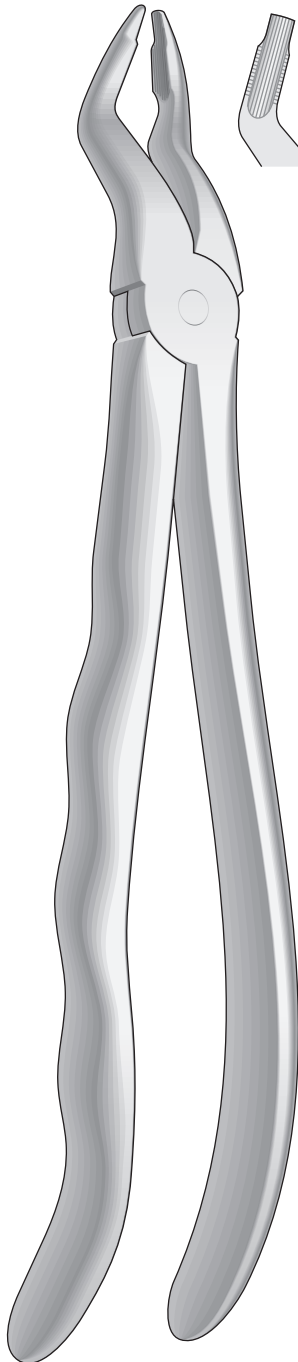

S-31
 Fig. 31

Obere Prämolaren
 Upper premolars
 Premolari superiori
 Premolares superiores
 Prémolaires supérieures

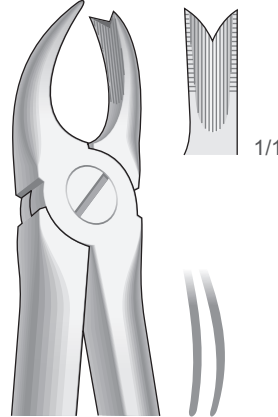
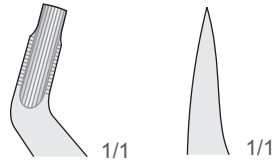

S-66R
 Fig. 66R (89)

Obere Molaren, rechts
 Upper molars, right
 Molari superiori, destra
 Molares superiores, derechos
 Molaires supérieures, droites

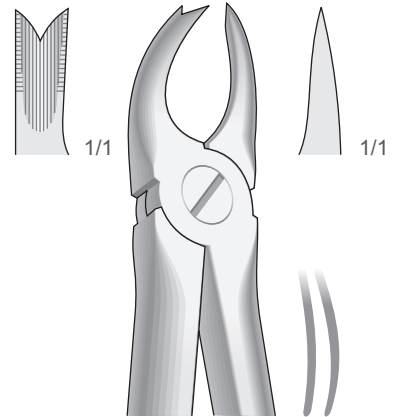

S-66L
 Fig. 66L (90)

Obere Molaren, links
 Upper molars, left
 Molari superiori, sinistra
 Molares superiores, izquierdos
 Molaires supérieures, gauches

Zahnzangen, Paßformgriff
 Extracting Forceps, Anatomical Handle
 Pinze per estrazione, Manico anatomico
 Pinzas da extracción, Mango anatómico
 Daviers, Manche anatomique

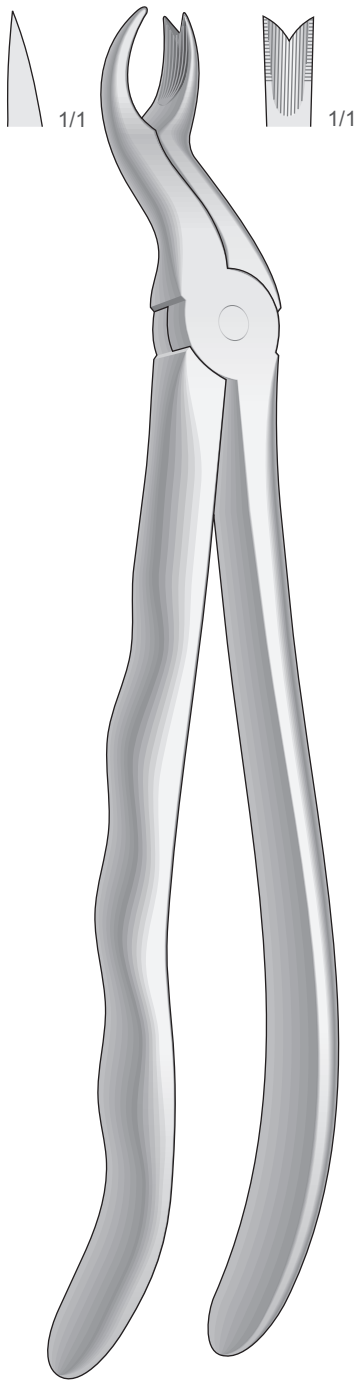

S-67R
 Fig. 67R

Obere Molaren, rechts
 Upper molars, right
 Molari superiori, destra
 Molares superiores, derechos
 Molaies supérieures, droites

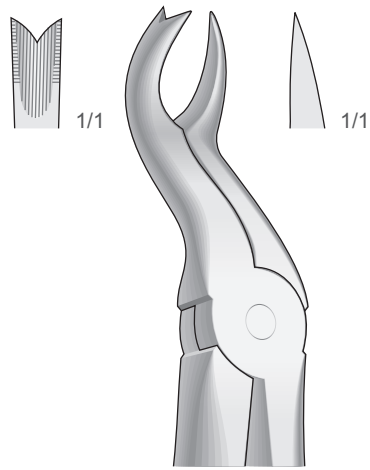

S-67L
 Fig. 67L

Obere Molaren, links
 Upper molars, left
 Molari superiori, sinistra
 Molares superiores, izquierdos
 Molaies supérieures, gauches

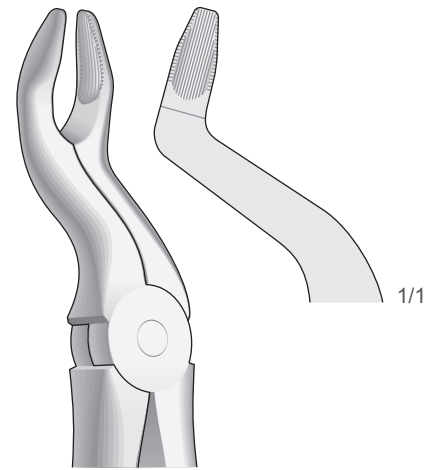

S-67N
 Fig. 67N

Obere Molaren
 Upper molars
 Molari superiori
 Molares superiores
 Molaies supérieures

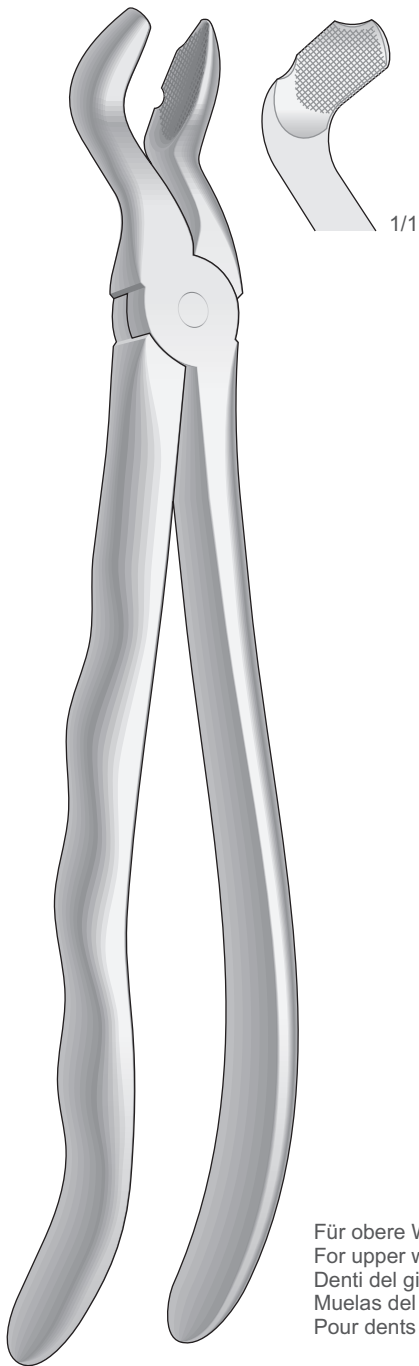

FELSCH
S-80
 Fig. 80

Für obere Weisheitszähne, mit Fangvorrichtung
 For upper wisdom teeth, with retaining device
 Denti del giudizio superiori, con dispositivo di presa
 Muelas del juicio superiores, con dispositivo de retencion
 Pour dents de sagesse supérieures, mors conçus pour recueillir la dent

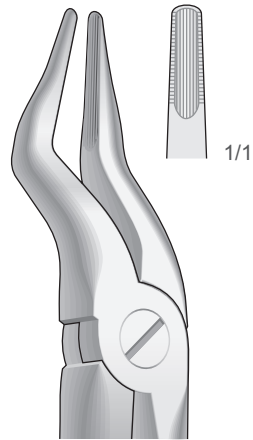

S-51B
 Fig. 51B

Obere Dritte Molaren
 Upper molars
 Ottavi superiori
 Molares superiores
 Molaires supérieures

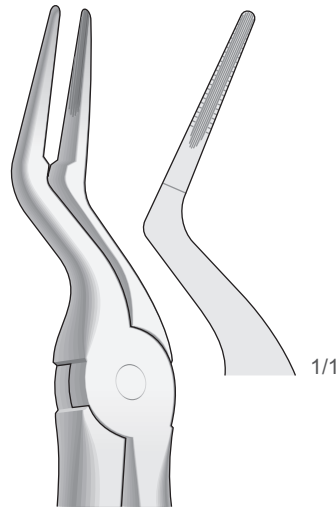

S-97
 Fig. 97

Obere Wurzelplitterzange
 Upper Root Fragments
 Frammenti e radici superiori
 Fragmentos de raíces superiores
 Fragments des racines supérieures

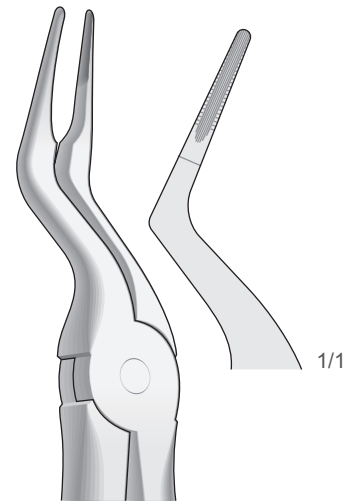

S-97B
 Fig. 97B

Obere Wurzelplitterzange
 Upper Root Fragments
 Frammenti e radici superiori
 Fragmentos de raíces superiores
 Fragments des racines supérieures

Zahnzangen, Paßformgriff
Extracting Forceps, Anatomical Handle
Pinze per estrazione, Manico anatomico
Pinzas da extracción, Mango anatómico
Daviers, Manche anatomique

Obere Wurzeln sehr feine
Upper very fine roots
Radici superiori molto sottili
Raíces superiores muy finas
Racines supérieures très fines

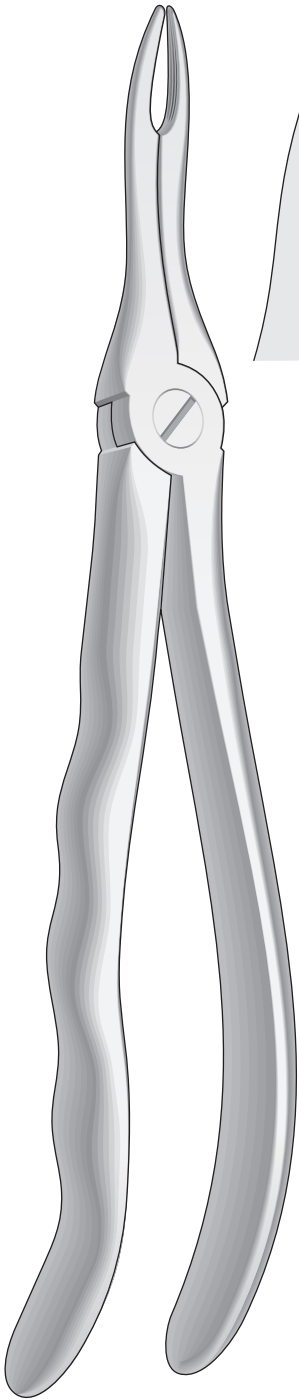

S-49
Fig. 49

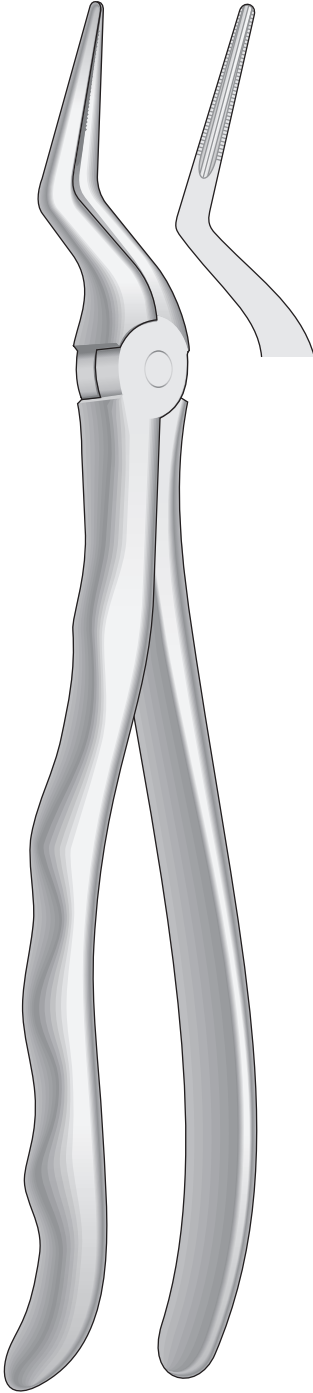

S-51LX
Fig. 51LX

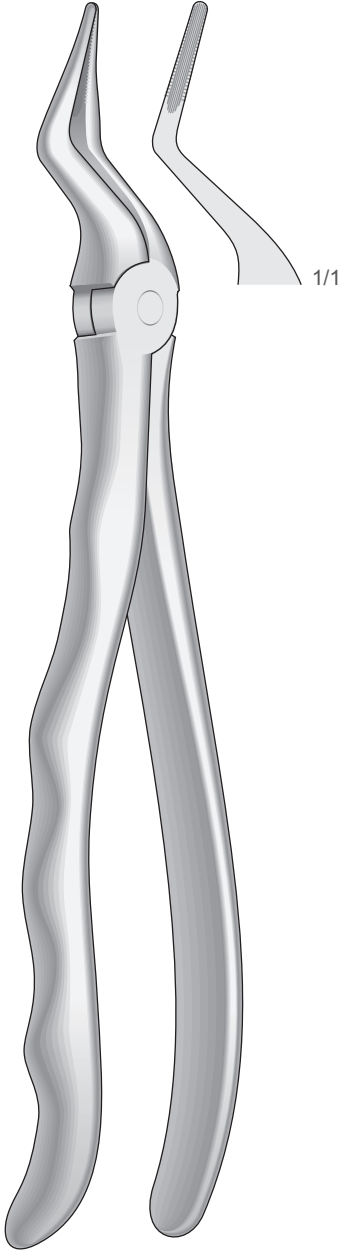

S-351S
Fig. 351S

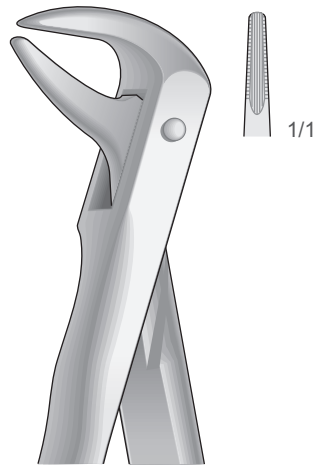

I-74N
 Fig. 74N

Untere Wurzeln Schneide- und Eckzähne
 Lower roots, incisors and cuspids
 Radici, incisivi e canini inferiori
 Raíces, incisivos y caninos inferiores
 Racines, incisives et canines inférieures

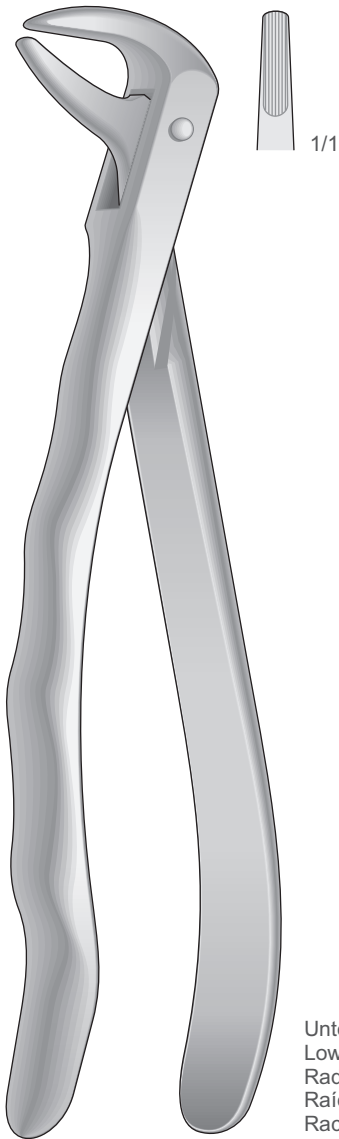

I-74
 Fig. 74

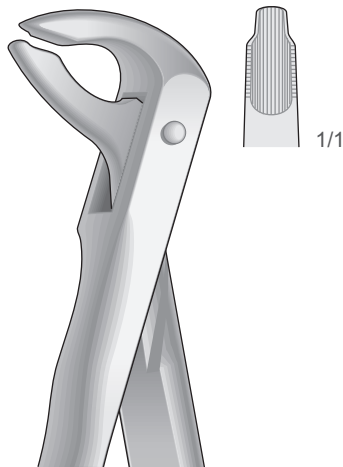

I-36
 Fig. 36

Untere Wurzeln Schneide- und Eckzähne
 Lower roots, incisors and cuspids
 Radici, incisivi e canini inferiori
 Raíces, incisivos y caninos inferiores
 Racines, incisives et canines inférieures

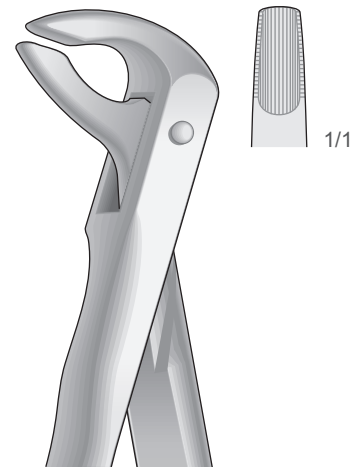

I-36N
 Fig. 36N

Untere Wurzeln Schneide- und Eckzähne
 Lower roots, incisors and cuspids
 Radici, incisivi e canini inferiori
 Raíces, incisivos y caninos inferiores
 Racines, incisives et canines inférieures

Untere Wurzeln Schneide- und Eckzähne
 Lower roots, incisors and cuspids
 Radici, incisivi e canini inferiori
 Raíces, incisivos y caninos inferiores
 Racines, incisives et canines inférieures

Zahnzangen, Paßformgriff
 Extracting Forceps, Anatomical Handle
 Pinze per estrazione, Manico anatomico
 Pinzas da extracción, Mango anatómico
 Daviers, Manche anatomique

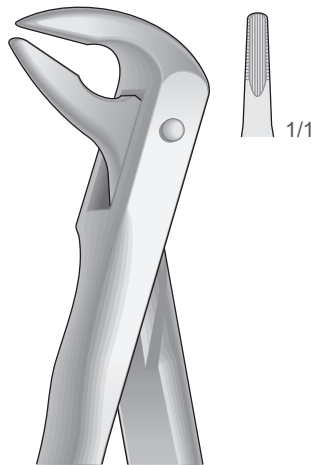

I-59
 Fig. 59

Untere Wurzelplitterzange
 Lower Root Fragments
 Frammenti e radici inferiori
 Fragmentos de raíces inferiores
 Fragments des racines inférieures

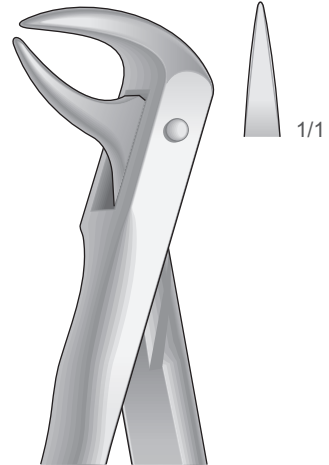

I-86C
 Fig. 86C

Untere Molaren mit kariesen oder abgebrochenen Kronen
 Lower molars with carious or broken caps
 Molari inferiori con corone cariate o spezzate
 Molares inferiores con coronas rotas o cariadas
 Molaire inférieures avec couronnes cariées ou cassées

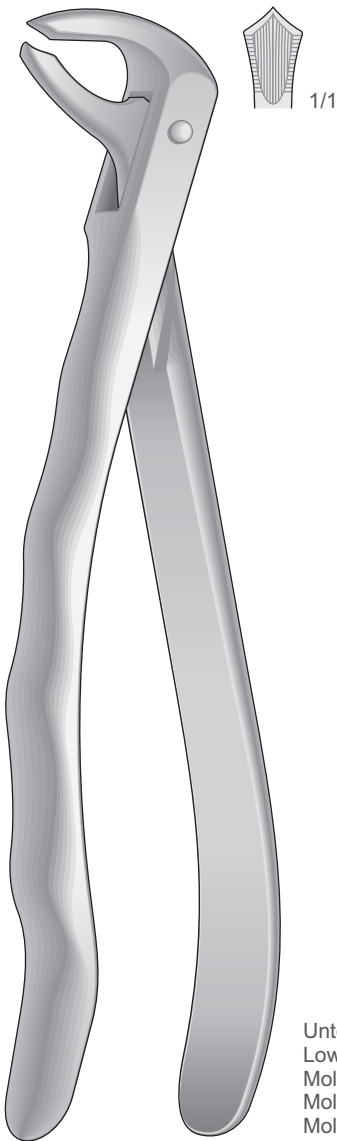

I-73
 Fig. 73

Untere Molaren
 Lower molars
 Molari inferiori
 Molares inferiores
 Molaire inférieures



I-13
 Fig. 13

Untere Prämolaren und Eckzähne
 Lower premolars and cuspids
 Canini e premolari inferiori
 Caninos y premolares inferiores
 Canines et prémolaires inférieures



I-22
 Fig. 22

Untere Molaren
 Lower molars
 Molari inferiori
 Molares inferiores
 Molaire inférieures

Untere Weisheitszähne
 Lower wisdom teeth
 Denti del giudizio inferiori
 Muelas del juicio inferiores
 Dent de sagesse inférieures

Untere Prämolaren
 Lower premolars
 Premolari inferiori
 Premolares inferiores
 Prémolaires inférieures

Untere Molaren
 Lower Molars
 Molari inferiori
 Molares inferiores
 Molaires inférieures

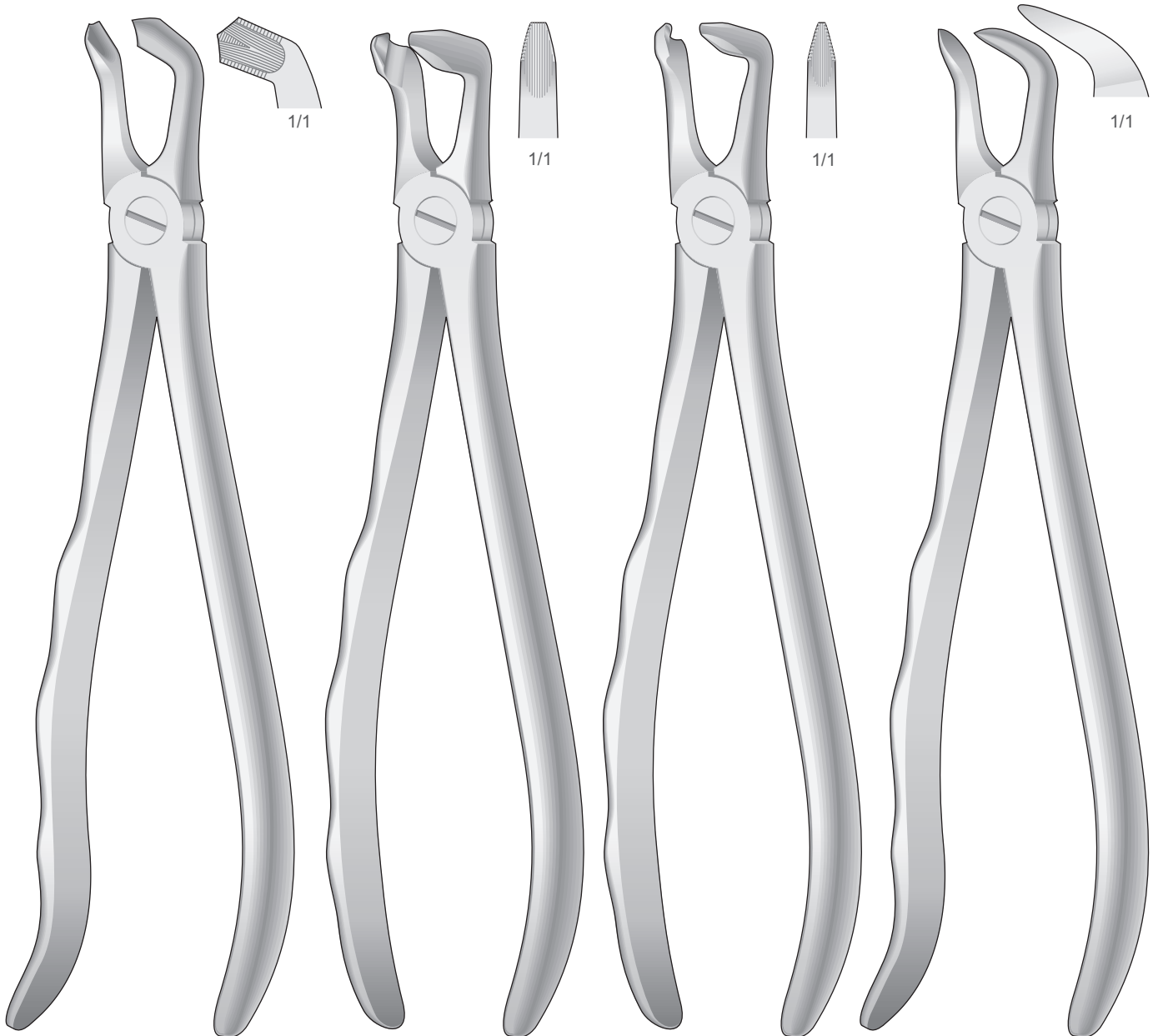

I-79
 Fig. 79

I-79N
 Fig. 79N

I-46N
 Fig. 46N

I-87
 Fig. 87

Zahnzangen, Paßformgriff
Extracting Forceps, Anatomical Handle
Pinze per estrazione, Manico anatomico
Pinzas da extracción, Mango anatómico
Daviers, Manche anatomique

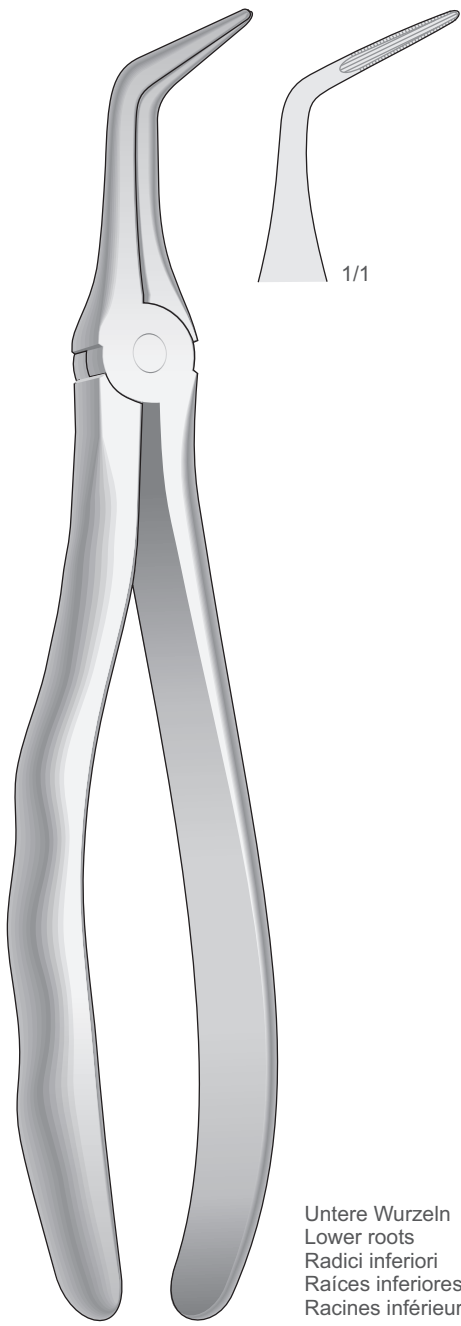

I-46LX
Fig. 46LX



I-46L
Fig. 46L

Untere Molaren und Weisheitszähne
 Lower molars and wisdom teeth
 Molari e denti del giudizio inferiori
 Molares y muelas del juicio inferiores
 Molaire et dent de sagesse inférieures

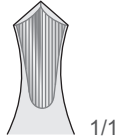
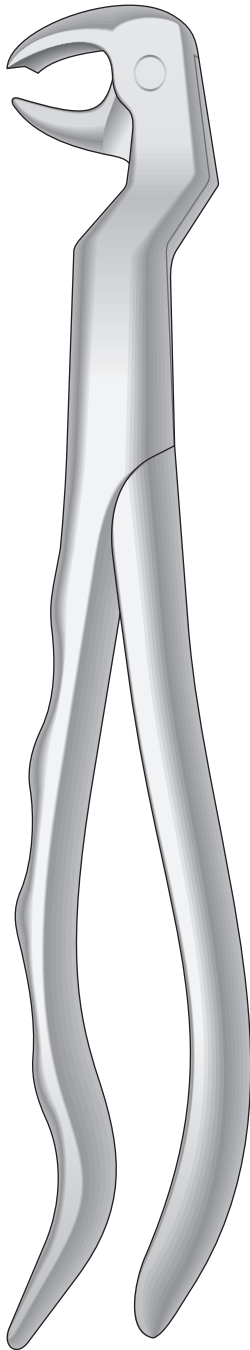

I-22 1/2 L

Links
 Left
 Sinistra
 Izquierdos
 Gauches

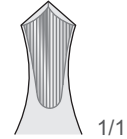
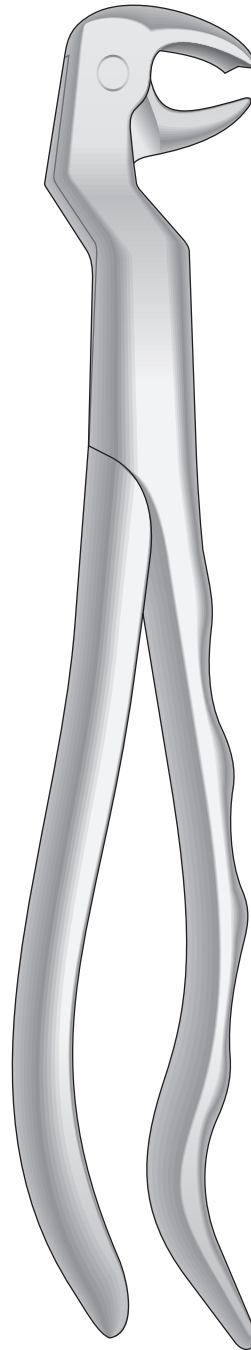

I-22 1/2 R

Rechts
 Right
 Destra
 Derechos
 Droites

Zahnzangen, Paßformgriff
 Extracting Forceps, Anatomical Handle
 Pinze per estrazione, Manico anatomico
 Pinzas da extracción, Mango anatómico
 Daviers, Manche anatomique

Untere Wurzeln sehr feine
 Lower very fine roots
 Radici inferiori molto sottili
 Raíces inferiores muy finas
 Racines inférieures très fines

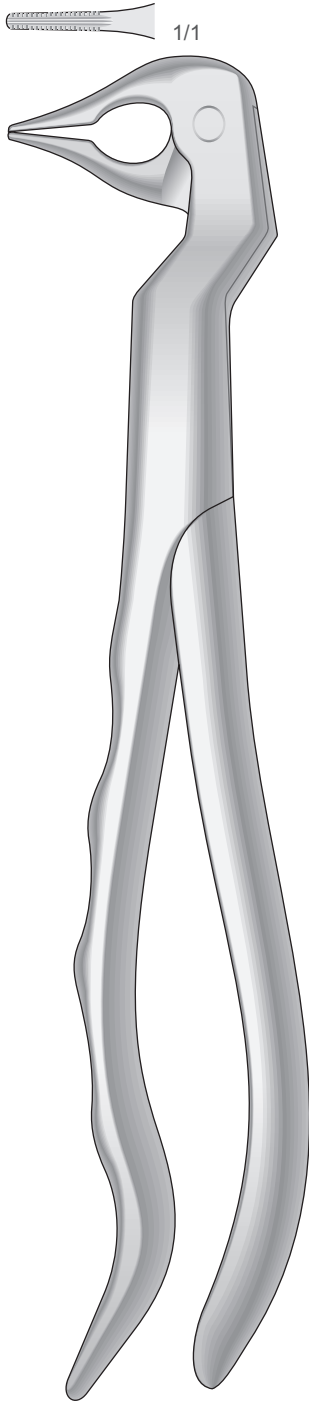

I-133 L
 Fig.133

Links
 Left
 Sinistra
 Izquierdos
 Gauches

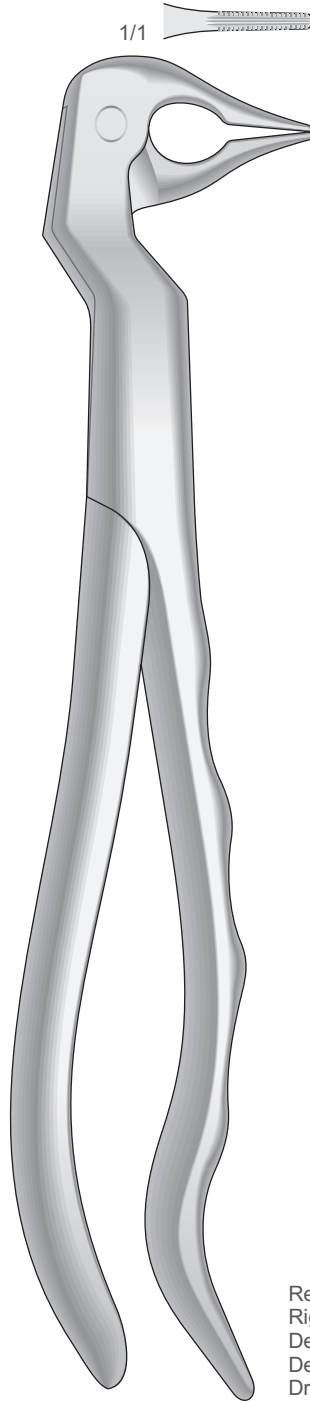

I-133 R
 Fig.133

Rechts
 Right
 Destra
 Derechos
 Droites

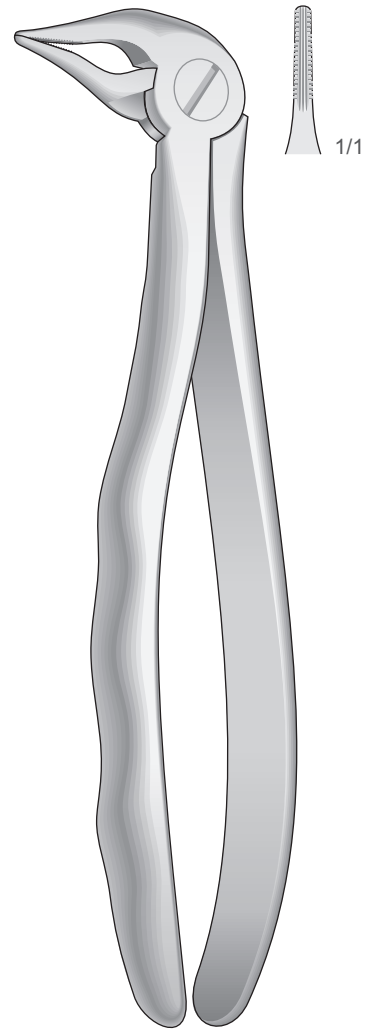

I-333S
 Fig.333S

Zahnzangen, Amerikanische Form
 Extracting Forceps, American Pattern
 Pinze per estrazione, Forma Americana
 Pinzas da extracción, Forma Americana
 Daviers, Forme Américaine

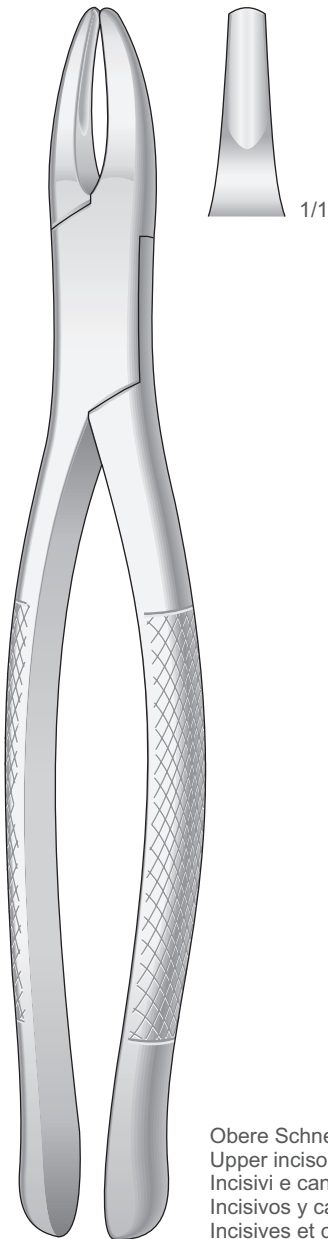

AM-1
 Fig. 1

Obere Schneide- und Eckzähne
 Upper incisors and cuspids
 Incisivi e canini superiori
 Incisivos y caninos superiores
 Incisives et canines supérieures

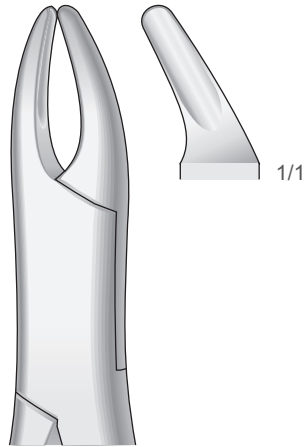

CRYER
AM-150
 Fig. 150

Obere Prämolaren, Schneidezähne, Wurzeln
 Upper Bicuspid, incisors and roots
 Premolari, incisivi e radici superiori
 Premolares, incisivos y raíces superiores
 Prémolaires, incisives et racines supérieures

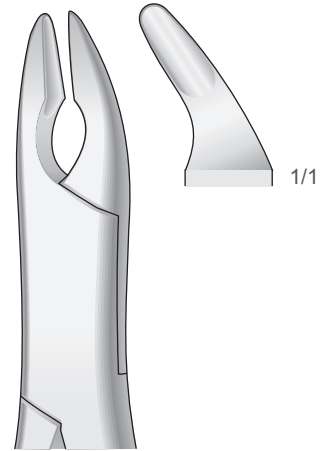

CRYER
AM-150A
 Fig. 150A

Obere Prämolaren, Schneidezähne, Wurzeln
 Upper Bicuspid, incisors and roots
 Premolari, incisivi e radici superiori
 Premolares, incisivos y raíces superiores
 Prémolaires, incisives et racines supérieures

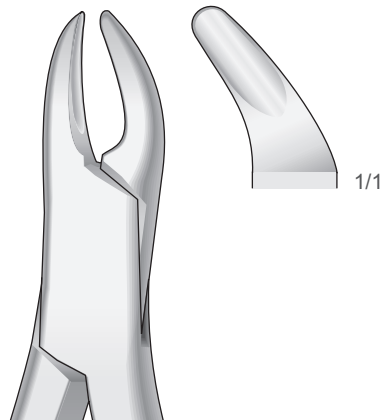

AM-62
 Fig. 62

Schneidezähne, Prämolaren, Milchzähne
 Incisors, premolars, deciduous teeth
 Incisivi, premolari, denti da latte
 Incisivos, premolares, dientes de leche
 Incisives, prémolaires, dents de lait

Zahnzangen, Amerikanische Form
 Extracting Forceps, American Pattern
 Pinze per estrazione, Forma Americana
 Pinzas da extracción, Forma Americana
 Daviers, Forme Américaine

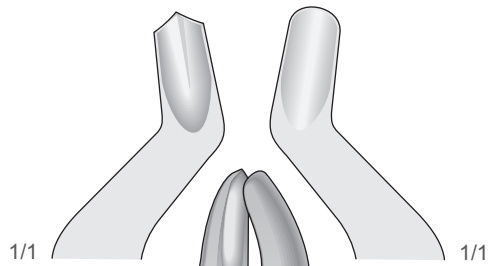

AM-53R
 Fig. 53R

Obere Molaren, Rechts
 Upper Molars, Right
 Molari superiori, Destra
 Molares superiores, Derechos
 Molaires supérieures, Droites

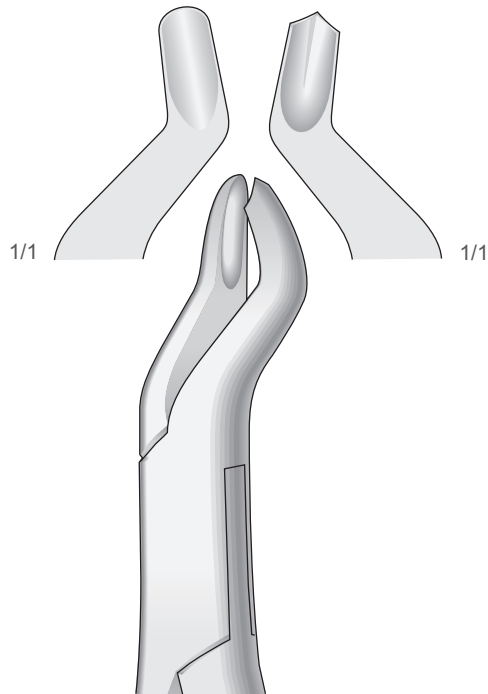

AM-53L
 Fig. 53L

Obere Molaren, Links
 Upper Molars, Left
 Molari superiori, Sinistra
 Molares superiores, Izquierdos
 Molaires supérieures, Gauches

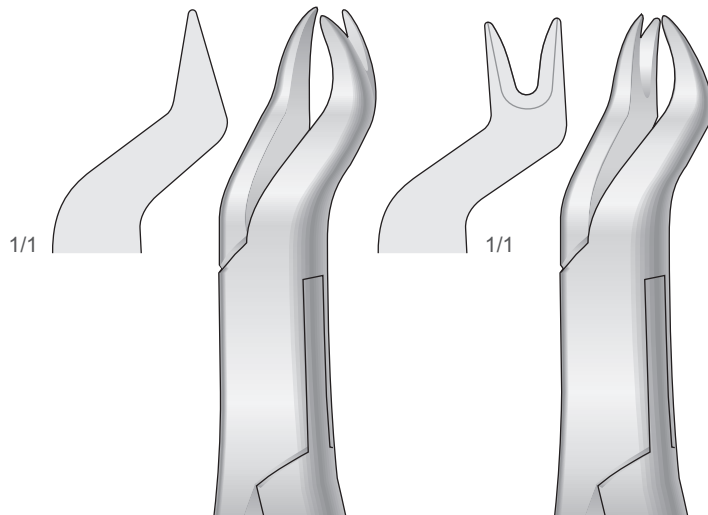

NEVIUS
AM-88R
 Fig. 88R

Obere Molaren, Rechts
 Upper Molars, Right
 Molari superiori, Destra
 Molares superiores, Derechos
 Molaires supérieures, Droites

NEVIUS
AM-88L
 Fig. 88L

Obere Molaren, Links
 Upper Molars, Left
 Molari superiori, Sinistra
 Molares superiores, Izquierdos
 Molaires supérieures, Gauches

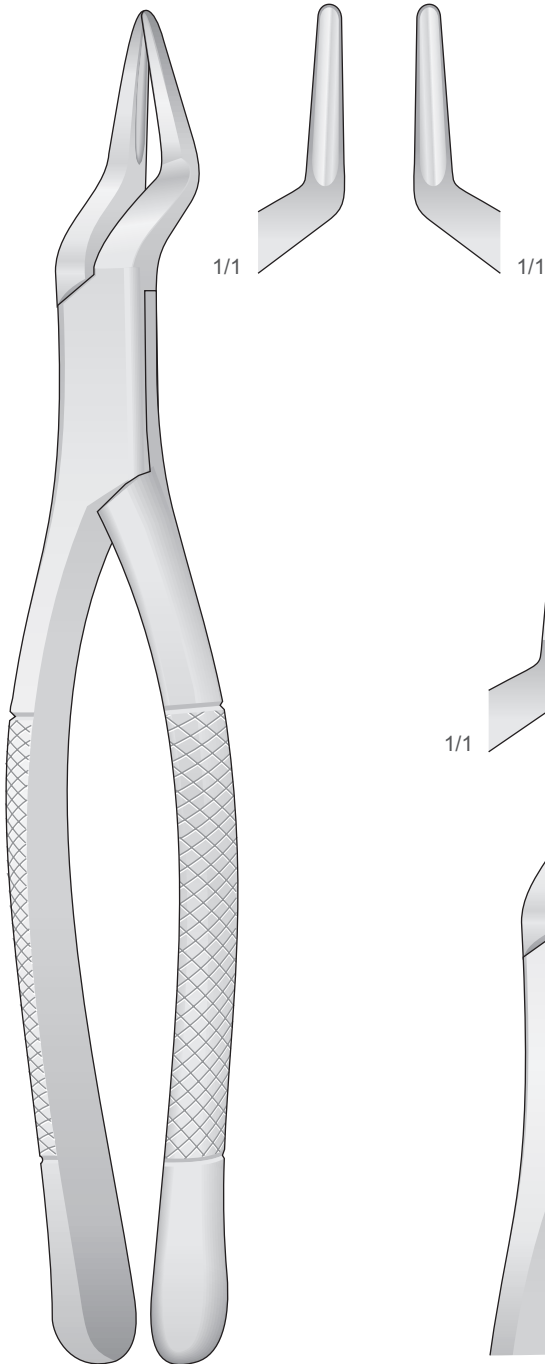

AM-65
 Fig.65

Obere Schneidezähne und Wurzeln
 Upper Incisors and Roots
 Incisivi e radici superiori
 Incisivos y raíces superiores
 Incisives et racines supérieures

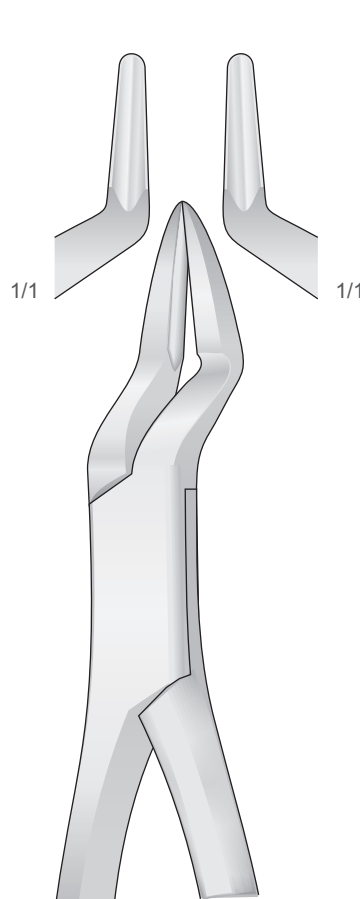

PARMLY
AM-32A
 Fig. 32A

Obere Wurzeln und Prämolaren
 Upper Roots and Premolars
 Radici e premolari superiori
 Raíces y premolares superiores
 Racines et prémolaires supérieures

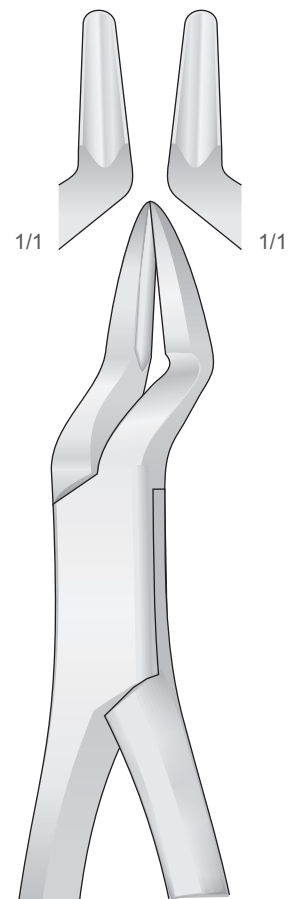

PARMLY
AM-32
 Fig. 32

Obere Prämolaren und Molaren
 Upper Premolars and Molars
 Premolari e molari superiori
 Premolares y Molares superiores
 Prémolaires et Molaires supérieures

Zahnzangen, Amerikanische Form
 Extracting Forceps, American Pattern
 Pinze per estrazione, Forma Americana
 Pinzas da extracción, Forma Americana
 Daviers, Forme Américaine

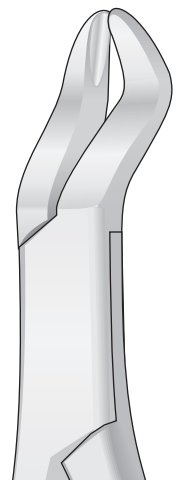
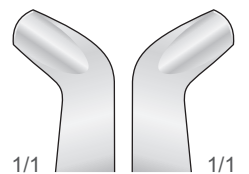
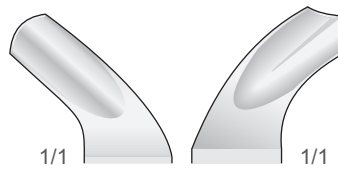
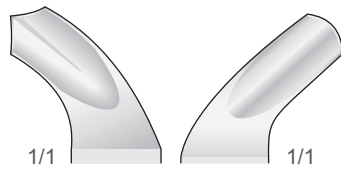

AM-24
 Fig. 24

Obere Molaren
 Upper Molars
 Molari superiori
 Molares superiores
 Molaires supérieures

**HARRIS
 AM-18R**
 Fig. 18R

Obere Molaren, Rechts
 Upper Molars, Right
 Molari superiori, Destra
 Molares superiores, Derechos
 Molaires supérieures, Droites

**HARRIS
 AM-18L**
 Fig. 18L

Obere Molaren, Links
 Upper Molars, Left
 Molari superiori, Sinistra
 Molares superiores, Isquierdos
 Molaires supérieures, Gauches

AM-210
 Fig. 210

Obere Molaren
 Upper Molars
 Molari superiori
 Molares superiores
 Molaires supérieures

Zahnzangen, Amerikanische Form
 Extracting Forceps, American Pattern
 Pinze per estrazione, Forma Americana
 Pinzas da extracción, Forma Americana
 Daviers, Forme Américaine

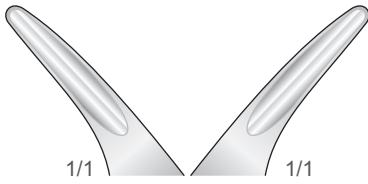

1/1 1/1

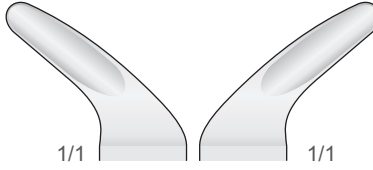

1/1 1/1



1/1 1/1

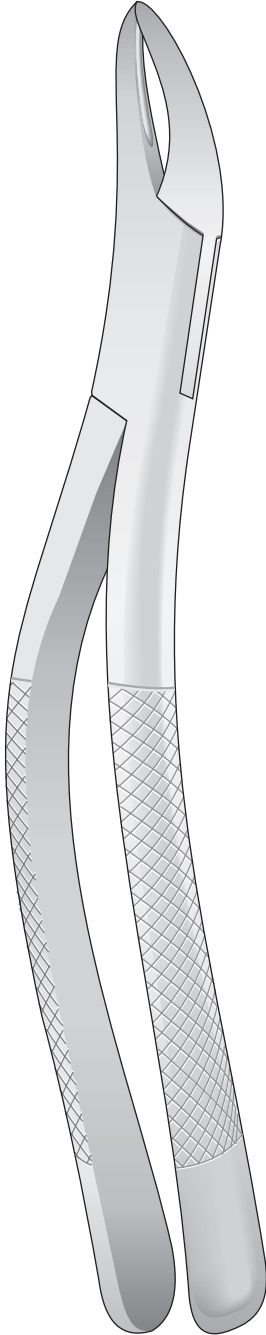

TOMES
AM-69
 Fig.69

Obere und Untere
 Upper and lower
 Superiori e inferiori
 Superiores y inferiores
 Supérieures et inférieures

Wurzeln
 Roots
 Radici
 Raíces
 Racines

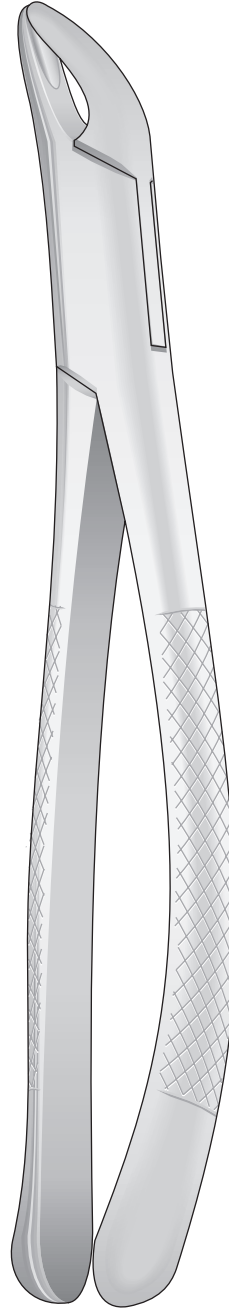

CRYER
AM-151
 Fig.151

Untere
 Lower
 Inferiori
 Inferiores
 Inférieures

Schneidezähne, Prämolaren, Wurzeln
 Incisors, Premolars, Roots
 Incisivi, premolari, radici
 Incisivos, premolares, raíces
 Incisives, prémolaires, racines



HULL
AM-101
 Fig. 101

Für Eckzähne und Prämolaren,
 Universalzange und Kinderzange
 For canines and Premolars,
 Universal and Tooth forceps for children
 Canini e premolari,
 universale e per bambini
 Caninos y premolares,
 universal y para niños
 Canines et prémolaires,
 universel et pour enfants

Zahnzangen, Amerikanische Form
 Extracting Forceps, American Pattern
 Pinze per estrazione, Forma Americana
 Pinzas da extracción, Forma Americana
 Daviers, Forme Américaine

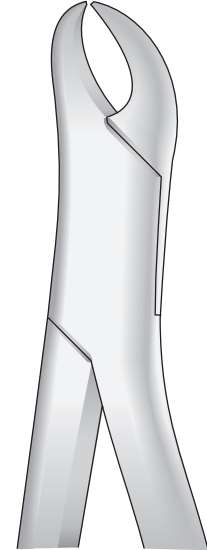
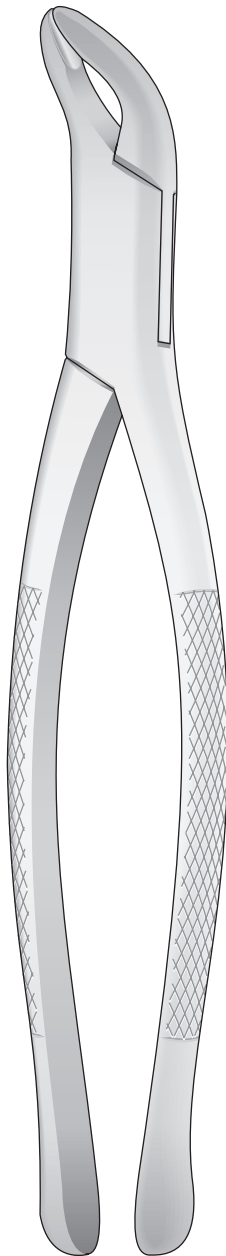
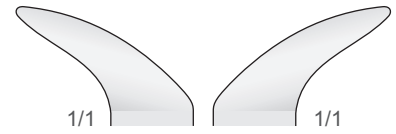
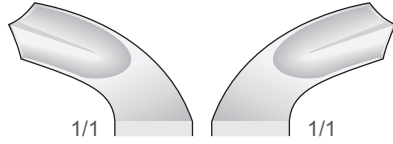

AM-17
 Fig. 17

Untere Molaren
 Lower Molars
 Molari inferiori
 Molares inferiores
 Molaires inférieures

AM-23
 Fig. 23

Untere Molaren
 Lower Molars
 Molari inferiori
 Molares inferiores
 Molaires inférieures

Untere Schneidezähne, Prämolaren, Wurzeln
 Lower Incisors, Premolars, Roots
 Incisivi, premolari, radici inferiori
 Incisivos, premolares, raices inferiores
 Incisives, prémolaires, racines inférieures

AM-203
 Fig. 203

Zahnzangen, Amerikanische Form
 Extracting Forceps, American Pattern
 Pinze per estrazione, Forma Americana
 Pinzas da extracción, Forma Americana
 Daviers, Forme Américaine

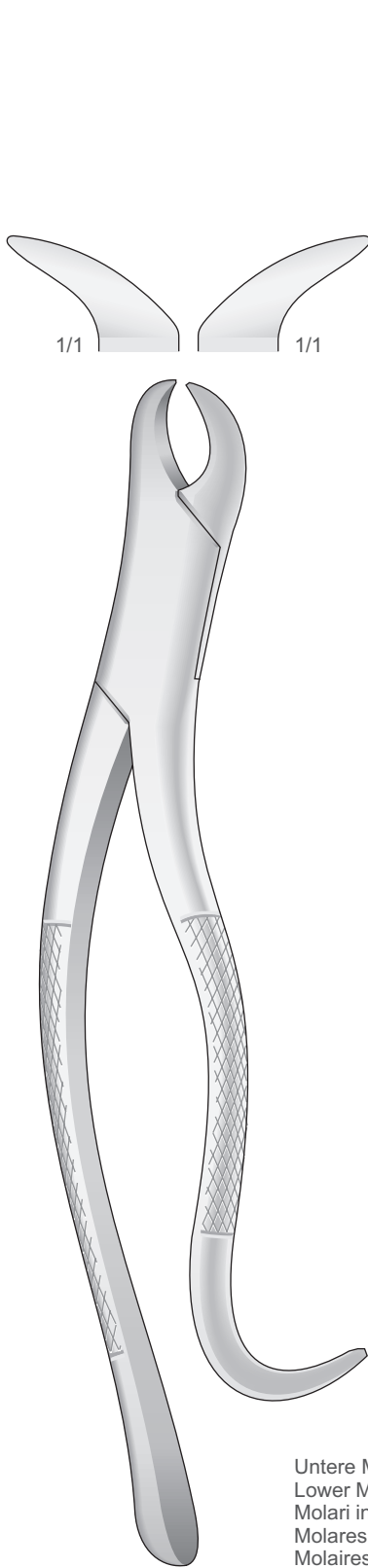

AM-16
 Fig. 16

Untere Molaren
 Lower Molars
 Molari inferiori
 Molares inferiores
 Molaires inférieures

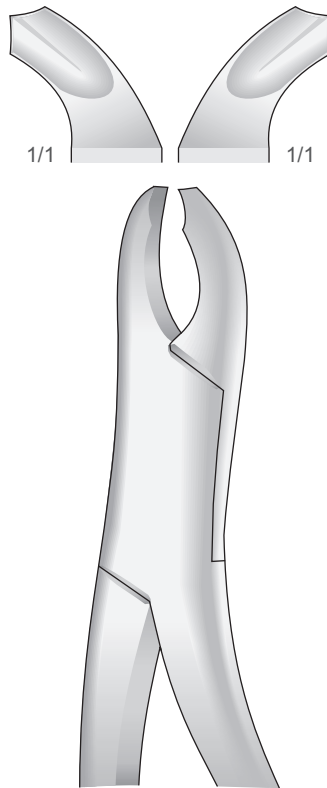

HARRIS
AM-15
 Fig. 15

Untere Molaren
 Lower Molars
 Molari inferiori
 Molares inferiores
 Molaires inférieures

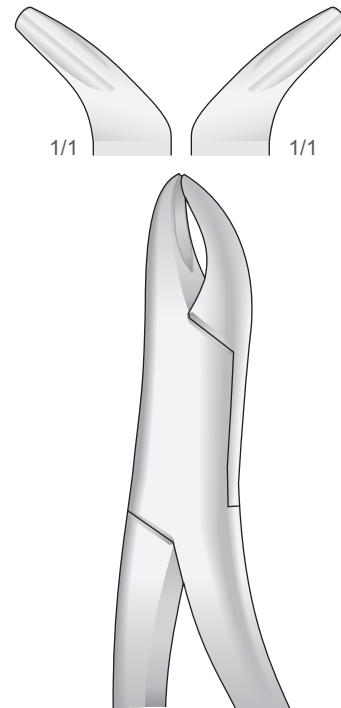

AM-103
 Fig. 103

Untere Schneidezähne, Prämolaren, Wurzeln
 Lower Incisors, Premolars, Roots
 Incisivi, premolari, radici inferiori
 Incisivos, premolares, raices inferiores
 Incisives, prémolaires, racines inférieures

Zahnzangen, Amerikanische Form
 Extracting Forceps, American Pattern
 Pinze per estrazione, Forma Americana
 Pinzas da extracción, Forma Americana
 Daviers, Forme Américaine

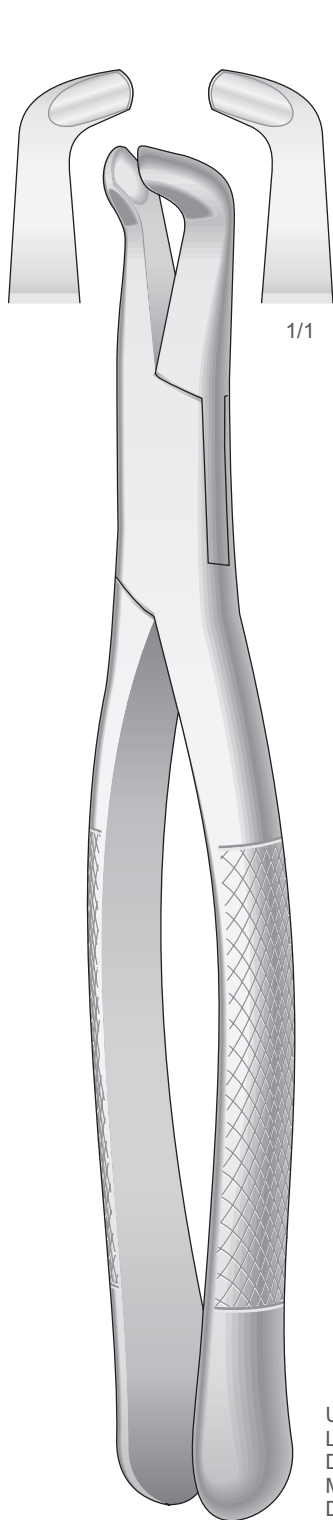

AM-222
 Fig. 222

Untere Weisheitszähne
 Lower wisdom teeth
 Denti del giudizio inferiori
 Muelas del juicio inferiores
 Dent de sagesse inférieures

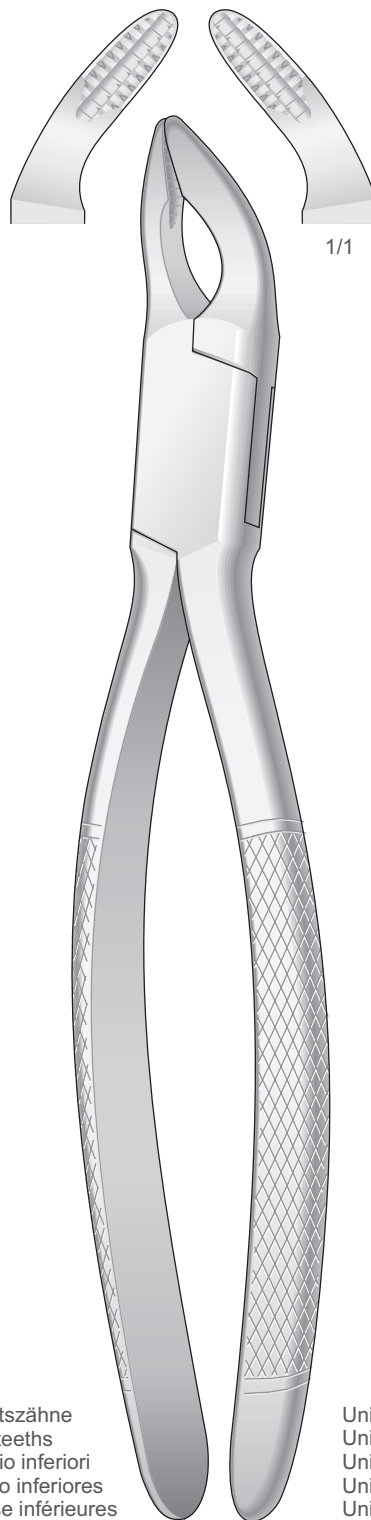

COHEN
AM-250

Universal
 Universal
 Universale
 Universal
 Universel

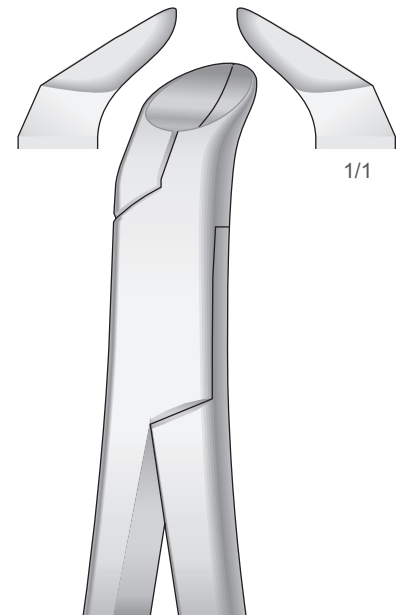

PHYSICK
AM-5
 Fig. 5

Untere Weisheitszähne
 Lower wisdom teeth
 Denti del giudizio inferiori
 Muelas del juicio inferiores
 Dent de sagesse inférieures

Zahnzangen, Amerikanische Form
 Extracting Forceps, American Pattern
 Pinze per estrazione, Forma Americana
 Pinzas da extracción, Forma Americana
 Daviers, Forme Américaine

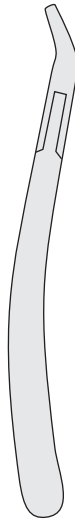
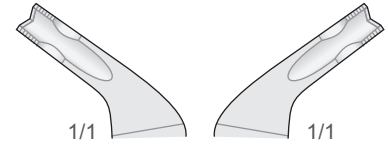
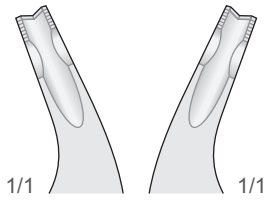

Obere
 Upper
 Superiori
 Superiores
 Supérieures

Prämolaren, Schneidezähne und Wurzeln
 Bicuspids, incisors and roots
 Premolari, incisivi e radici
 Premolares, incisivos y raíces
 Premolaires, incisives et racines



Untere
 Lower
 Inferiori
 Inferiores
 Inférieures

Prämolaren, Schneidezähne und Wurzeln
 Bicuspids, incisors and roots
 Premolari, incisivi e radici
 Premolares, incisivos y raíces
 Premolaires, incisives et racines



AM-150X
 Fig. 150AS

AM-151X
 Fig. 151AS

Zahnzangen, Amerikanische Form
 Extracting Forceps, American Pattern
 Pinze per estrazione, Forma Americana
 Pinzas da extracción, Forma Americana
 Daviers, Forme Américaine

Für Kinder
 For children
 Per bambini
 Para niños
 Pour enfants

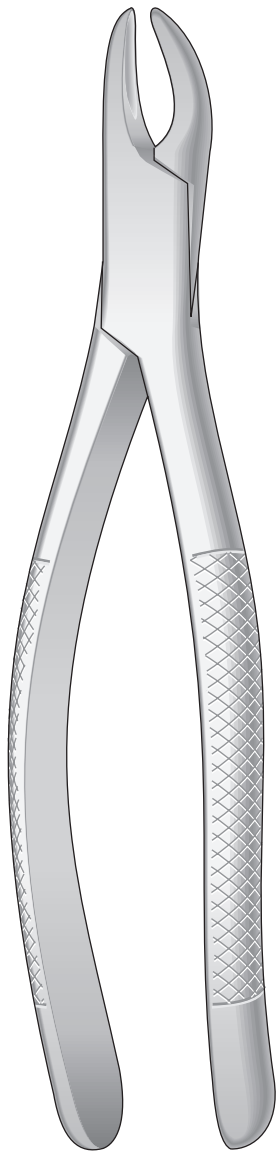
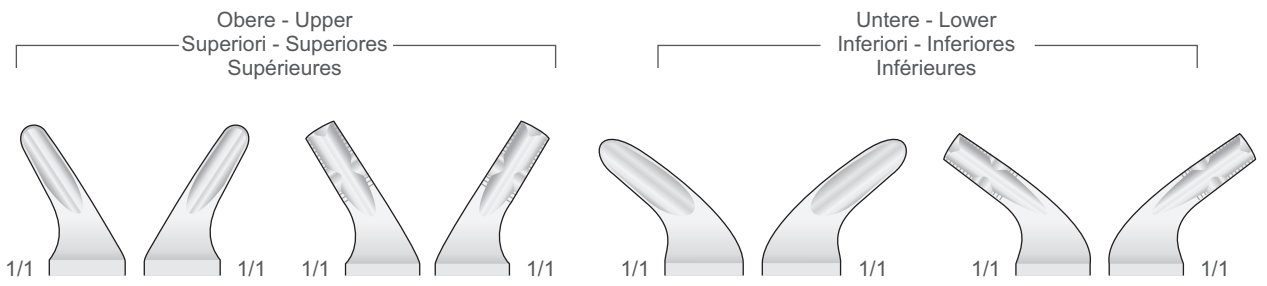

CRYER
AM-150S
 Fig.150 S

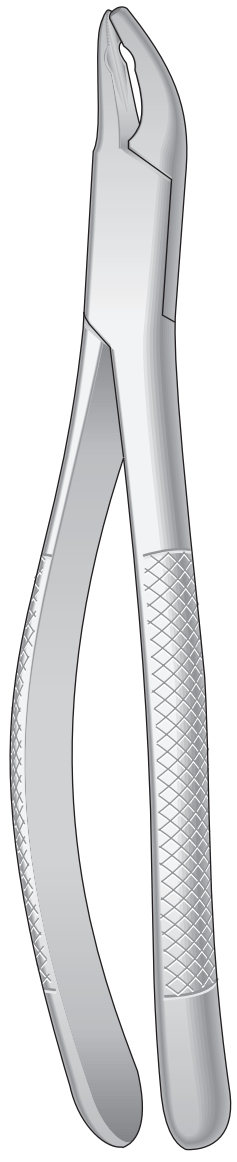

AM-150AS
 Fig.150 XAS

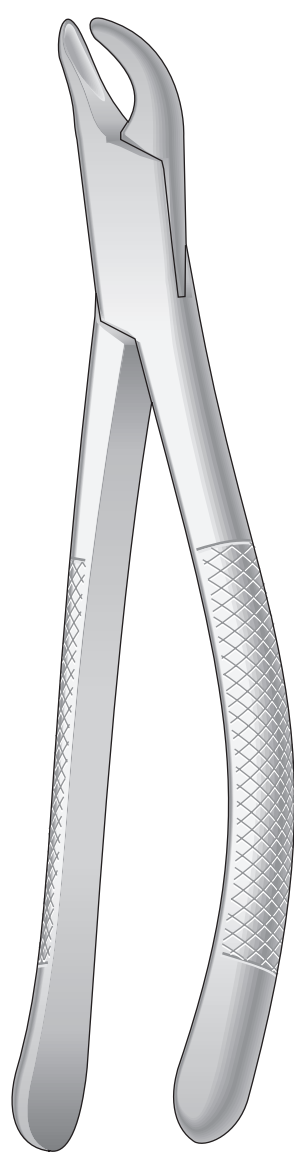

CRYER
AM-151S
 Fig.151 S



AM-151AS
 Fig.151 XAS

Geriefte - Serrated - Striata - Estriadas - Striées

Obere Schneidezähne, Prämolaren, Wurzeln
 Upper incisors, premolars, roots
 Incisivi, premolari e radici superiori
 Incisivos, premolares y raíces superiores
 Incisives, premolaires et racines supérieures

Untere Schneidezähne, Prämolaren, Wurzeln
 Lower incisors, premolars, roots
 Incisivi, premolari e radici inferiori
 Incisivos, premolares y raíces inferiores
 Incisives, premolaires et racines inférieures

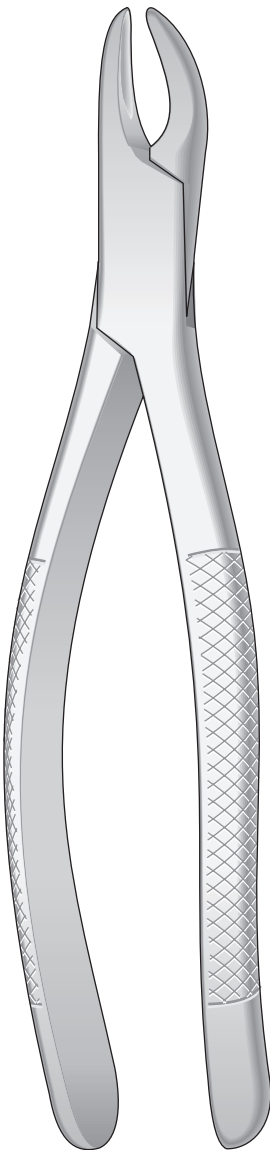
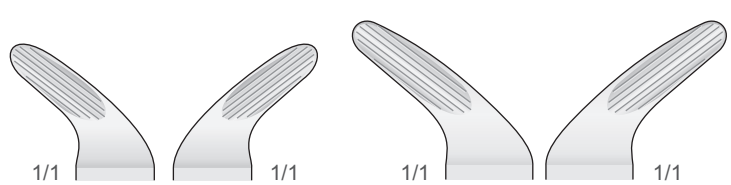
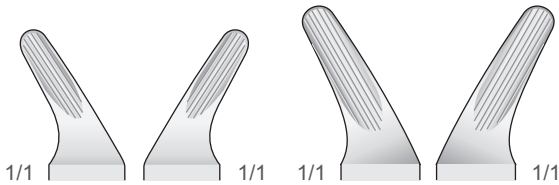

CRYER
AMG-150
 Fig. 150

Für Erwachsene
 For adults
 Per adulti
 Para adultos
 Pour adults

Für Kinder
 For children
 Per bambini
 Para niños
 Pour enfants

CRYER
AMG-150S
 Fig.150 S

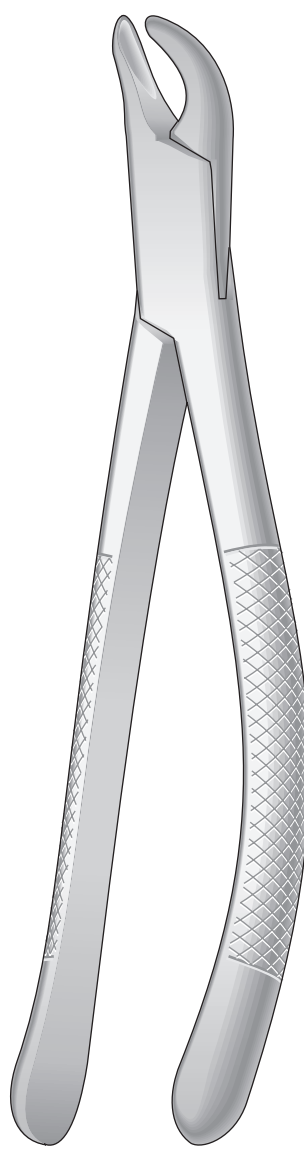

CRYER
AMG-151
 Fig. 151

Für Erwachsene
 For adults
 Per adulti
 Para adultos
 Pour adults

Für Kinder
 For children
 Per bambini
 Para niños
 Pour enfants

CRYER
AMG-151S
 Fig.151 S

Zahnzangen
 Extracting Forceps
 Pinze per estrazione
 Pinzas da extracción
 Daviers

Schneidezähne, Eckzähne, Wurzeln
 Incisors, bicuspid and roots
 Incisivi, canini e radici
 Incisivos, caninos y raíces
 Incisives, canines et racines

Molaren
 Molars
 Molari
 Molares
 Molaïres

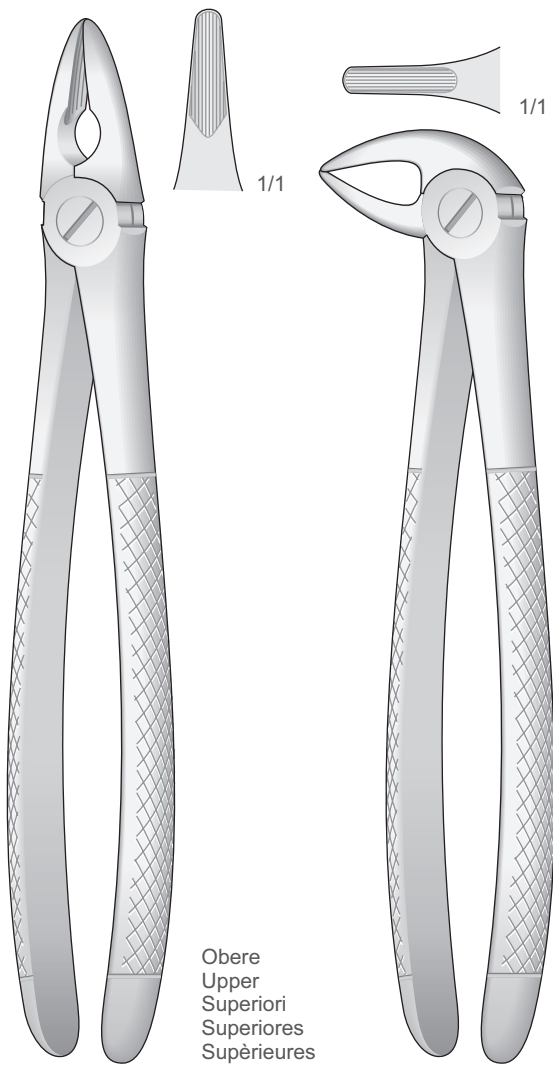

Obere
 Upper
 Superiori
 Supérieures

Untere
 Lower
 Inferiori
 Inférieures

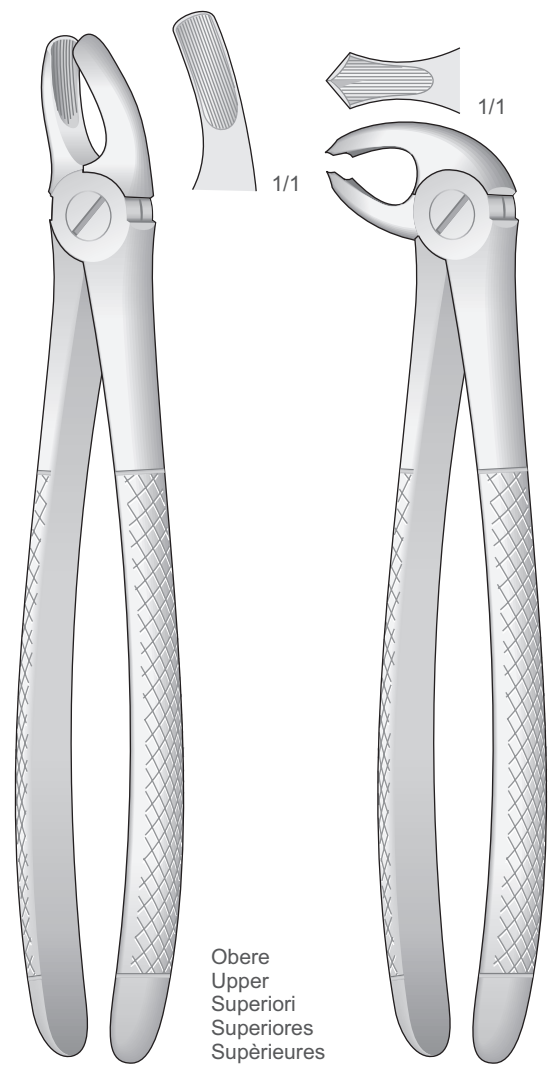

Obere
 Upper
 Superiori
 Supérieures

Untere
 Lower
 Inferiori
 Inférieures

MEAD
 MD-1

MEAD
 MD-3

MEAD
 MD-2

MEAD
 MD-4

Kinderzahnzangen, Amerikanische Form
 Extracting Forceps for children, American Pattern
 Pinze per estrazione per bambini, Forma Americana
 Forceps dentales para niños, Forma Americana
 Daviers pour enfants, Forme Américaine

Molaren
 Pedo Lower Molars
 Molari
 Molares
 Molaires

Molaren
 Pedo Lower Molars
 Molari
 Molares
 Molaires

Zähne und wurzeln
 Pedo upper incisors
 Bicuspid and roots
 Denti e radici
 Dientes y raíces
 Dentes et racines

Zähne und wurzeln
 Pedo lower incisors
 Bicuspid and roots
 Denti e radici
 Dientes y raíces
 Dentes et racines

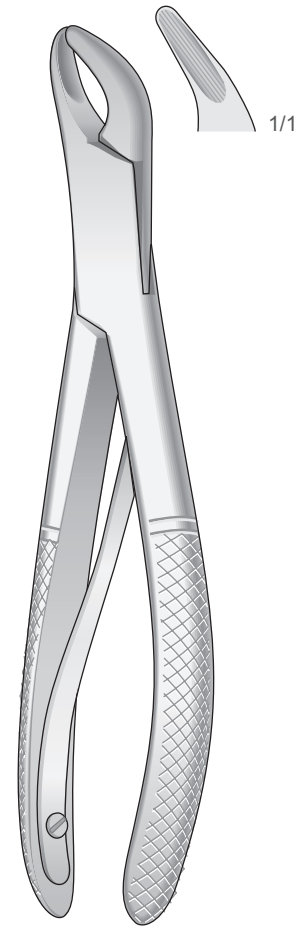
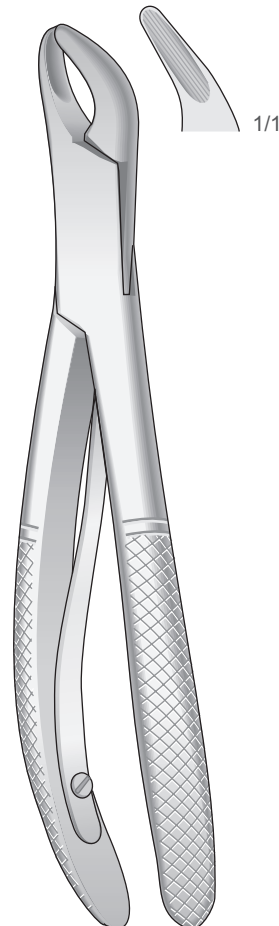
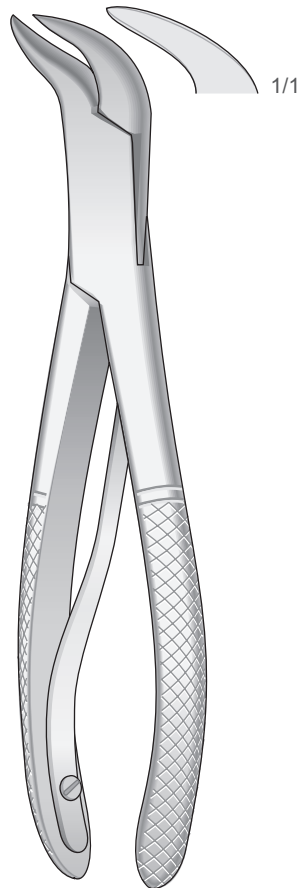
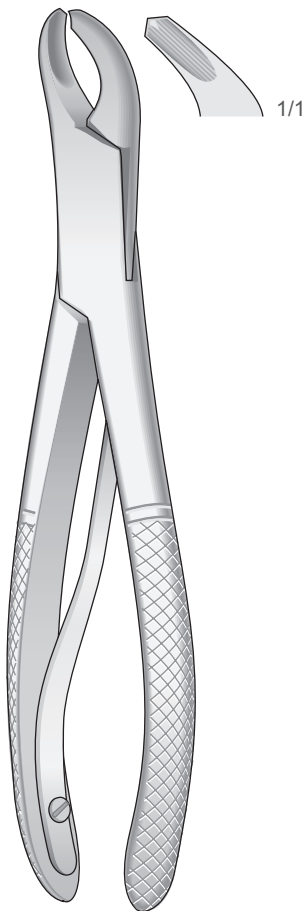

PEB-17S
 Fig. 17SK

PEB-23S
 Fig. 23SK

PEB-150S
 Fig. 150SK

PEB-151S
 Fig. 151SK

Kinderzahnzangen
 Extracting Forceps for children
 Pinze per estrazione per bambini
 Forceps dentales para niños
 Daviers pour enfants

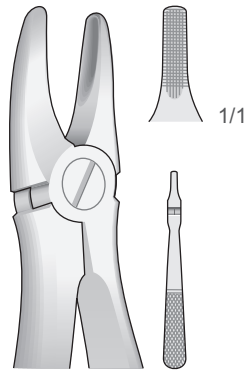

PEB-1
 Fig. 137

Obere Schneidezähne
 Upper Incisors
 Incisivi superiori
 Incisivos superiores
 Incisives supérieures

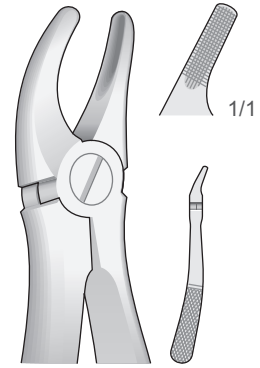

PEB-2
 Fig. 139

Obere Prämolaren
 Upper Premolars
 Premolari superiori
 Premolares superiores
 Prémolaires supérieures

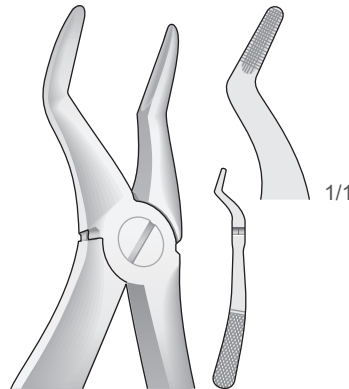

PEB-4
 Fig. 51S

Obere Wurzeln
 Upper roots
 Radici superiori
 Raíces superiores
 Racines supérieures

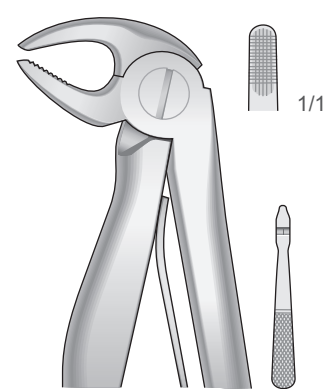

PEB-5
 Fig. 5

Untere Schneidezähne
 Lower incisors
 Incisivi inferiori
 Incisivos inferiores
 Incisives inférieures

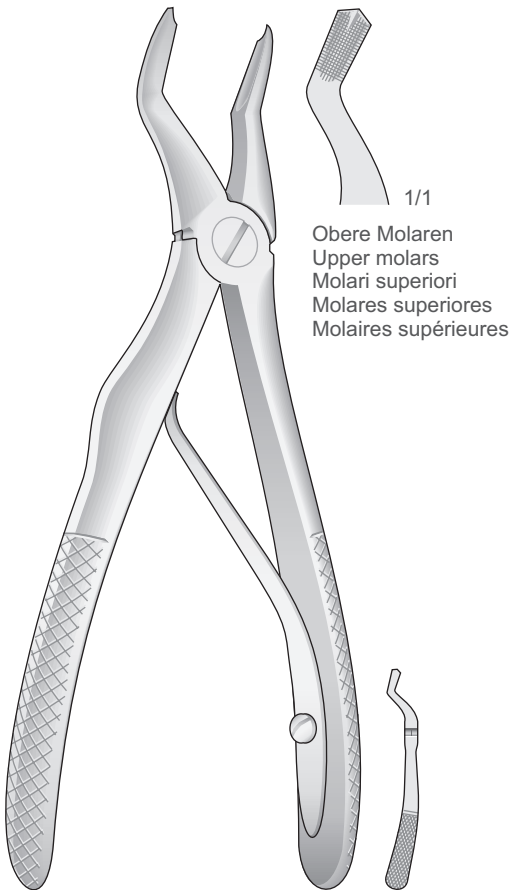

PEB-3

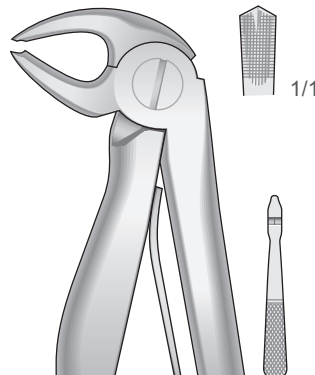

PEB-6
 Fig. 6

Untere Molaren
 Lower Molars
 Molari inferiori
 Molares inferiores
 Molaires inférieures

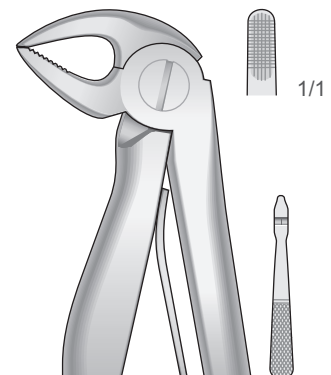

PEB-7
 Fig. 7

Untere Wurzeln
 Lower roots
 Radici inferiori
 Raíces inferiores
 Racines inférieures

Root Fragment Forceps

FORCEPS

Wurzelfragmentinstrumente
 Root Fragment Forceps
 Strumenti per frammenti di radici
 Instrumentos para fragmentos de raíces
 Instruments pour fragments de racines

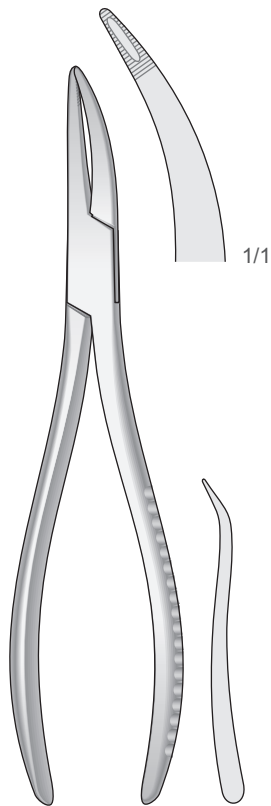

Obere Wurzeln, Universal
 Upper roots, Universal
 Radici superiori, Universale
 Raíces superiores, Universal
 Racines superieures, Universel

**WITZEL
 DK-26**
 170 mm

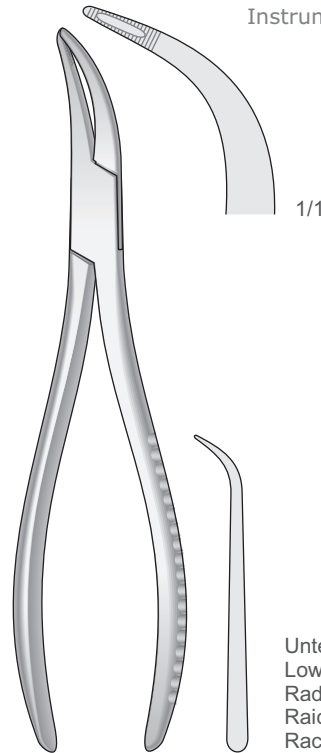

Untere Wurzeln, Universal
 Lower roots, Universal
 Radici inferiori, Universale
 Raíces inferiores, Universal
 Racines inferieures, Universel

**WITZEL
 DK-28**
 165 mm

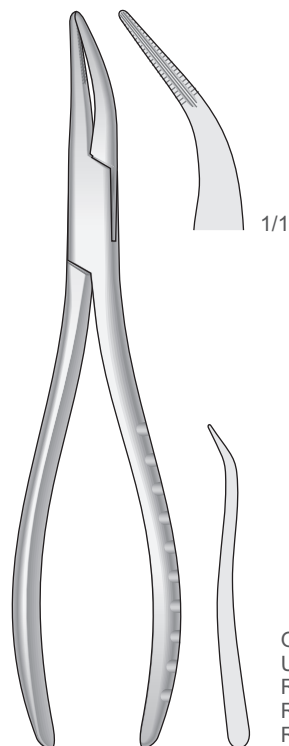

Obere Wurzeln, Universal
 Upper roots, Universal
 Radici superiori, Universale
 Raíces superiores, Universal
 Racines superieures, Universel

S-400
 # 400 (300)
 165 mm

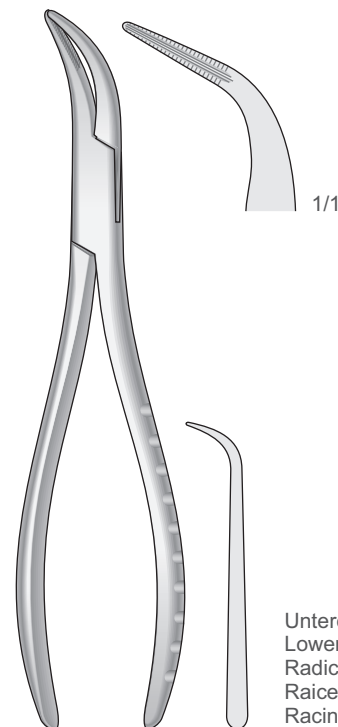

Untere Wurzeln, Universal
 Lower roots, Universal
 Radici inferiori, Universale
 Raíces inferiores, Universal
 Racines inferieures, Universel

I-401
 # 401 (301)
 160 mm

Wurzelfragmentinstrumente
 Root Fragment Forceps
 Strumenti per frammenti di radici
 Instrumentos para fragmentos de raíces
 Instruments pour fragments de racines

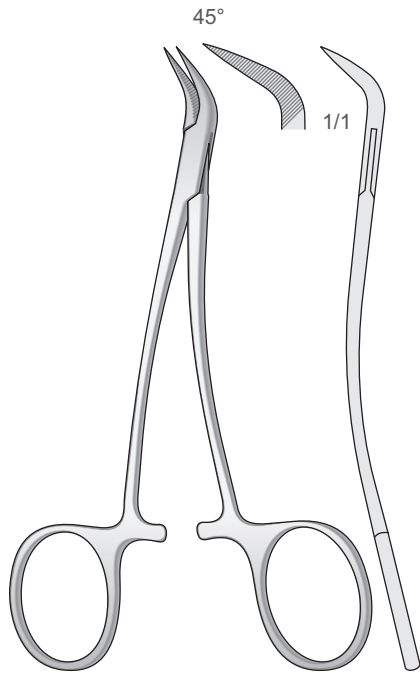

PEET
DR-40
 120 mm

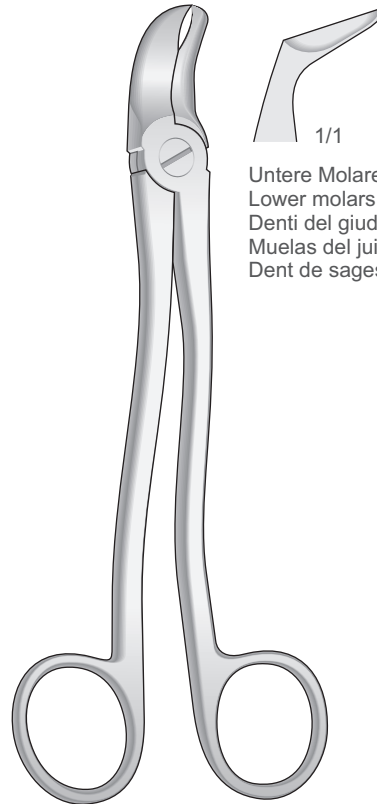

RO-1
 175 mm

Untere Molaren und Weisheitszähne
 Lower molars and wisdom teeth
 Denti del giudizio e molari inferiori
 Muelas del juicio y molares inferiores
 Dent de sagesse et molaires inférieures

Wurzelfragmente
 Root fragments
 Frammenti di radici
 Fragmentos de raíces
 Fragments de racines

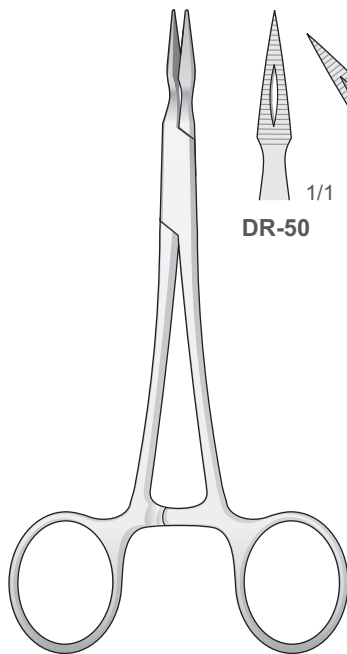

STIEGLITZ
DR-50/DR-60
 140 mm

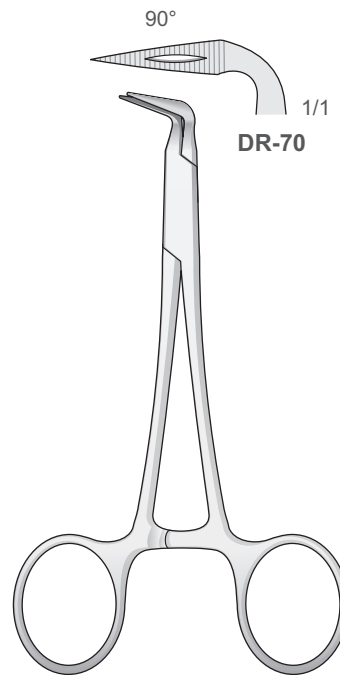

STIEGLITZ
DR-70
 120 mm

Wurzelfragmentinstrumente
 Root Fragment Forceps
 Strumenti per frammenti di radici
 Instrumentos para fragmentos de raíces
 Instruments pour fragments de racines

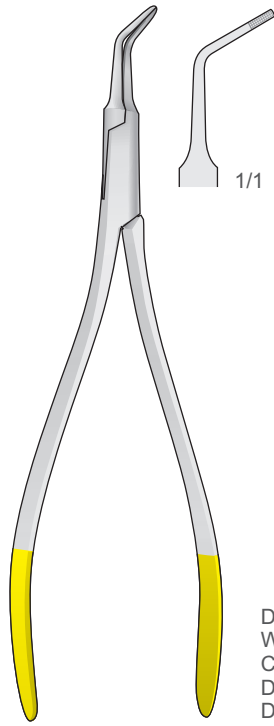

DA-01M
130 mm

Diamantiert
 With Diamond
 Con diamante
 Diamantada
 Diamantées

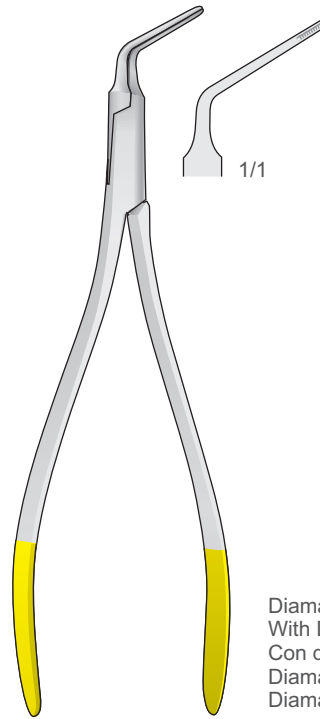

DA-10
130 mm

Diamantiert
 With Diamond
 Con diamante
 Diamantada
 Diamantées

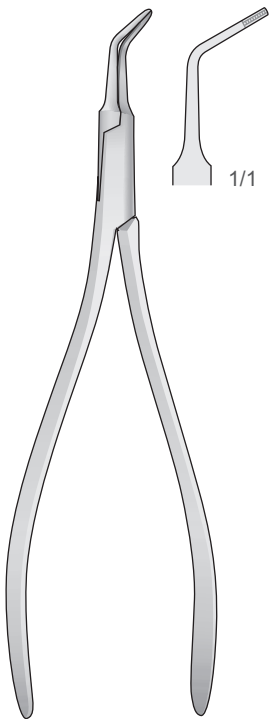

DA-01
130 mm

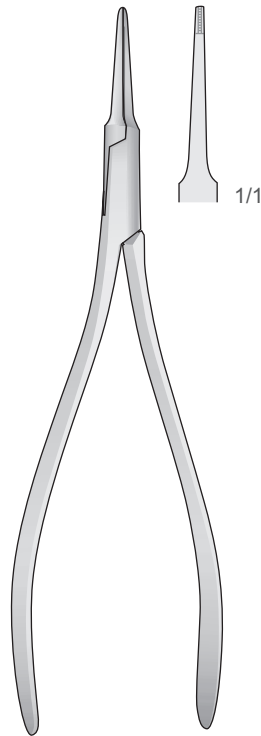

DA-02
130 mm

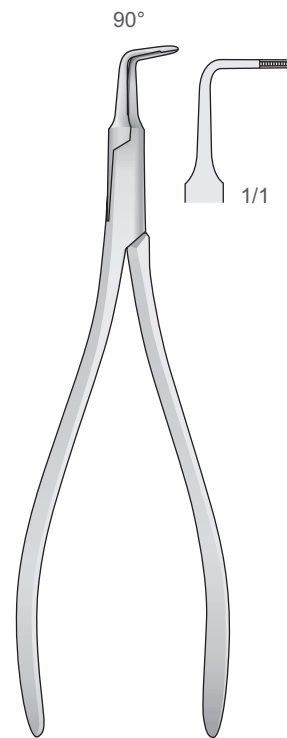

DA-03
125 mm

• Elevators

43 | Root and Luxating Elevators

ELEVATORS



Wurzelheber
 Root Elevators
 Leve per radici
 Elevadores para raíces
 Elevateurs à racines

Root and Luxating Elevators

ELEVATORS

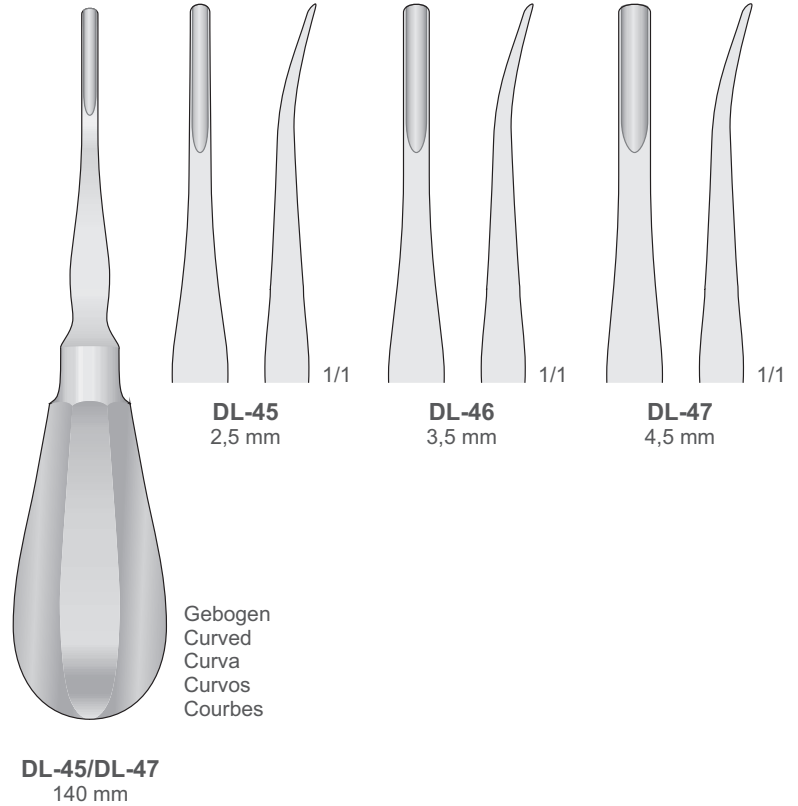
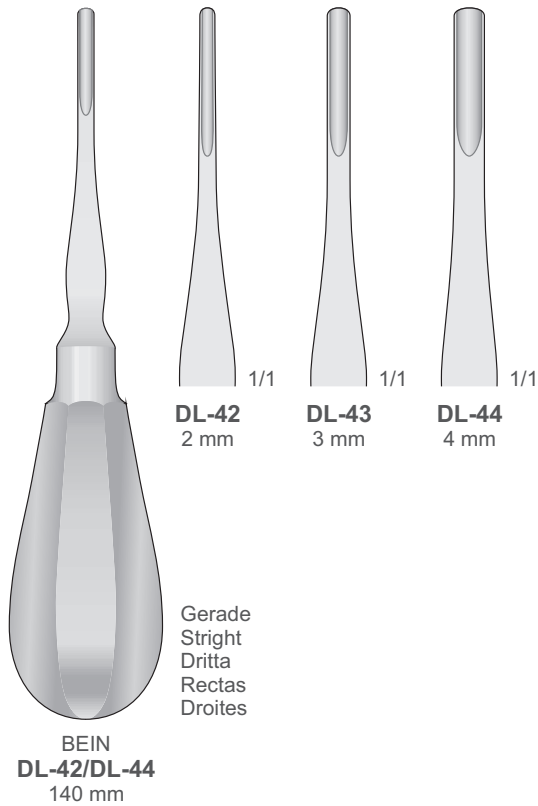

SMALL HANDLE

Luxierinstrumente | Luxating Elevators | Elevatori di lussazione | Elevadores de luxación | Élévateurs de luxation

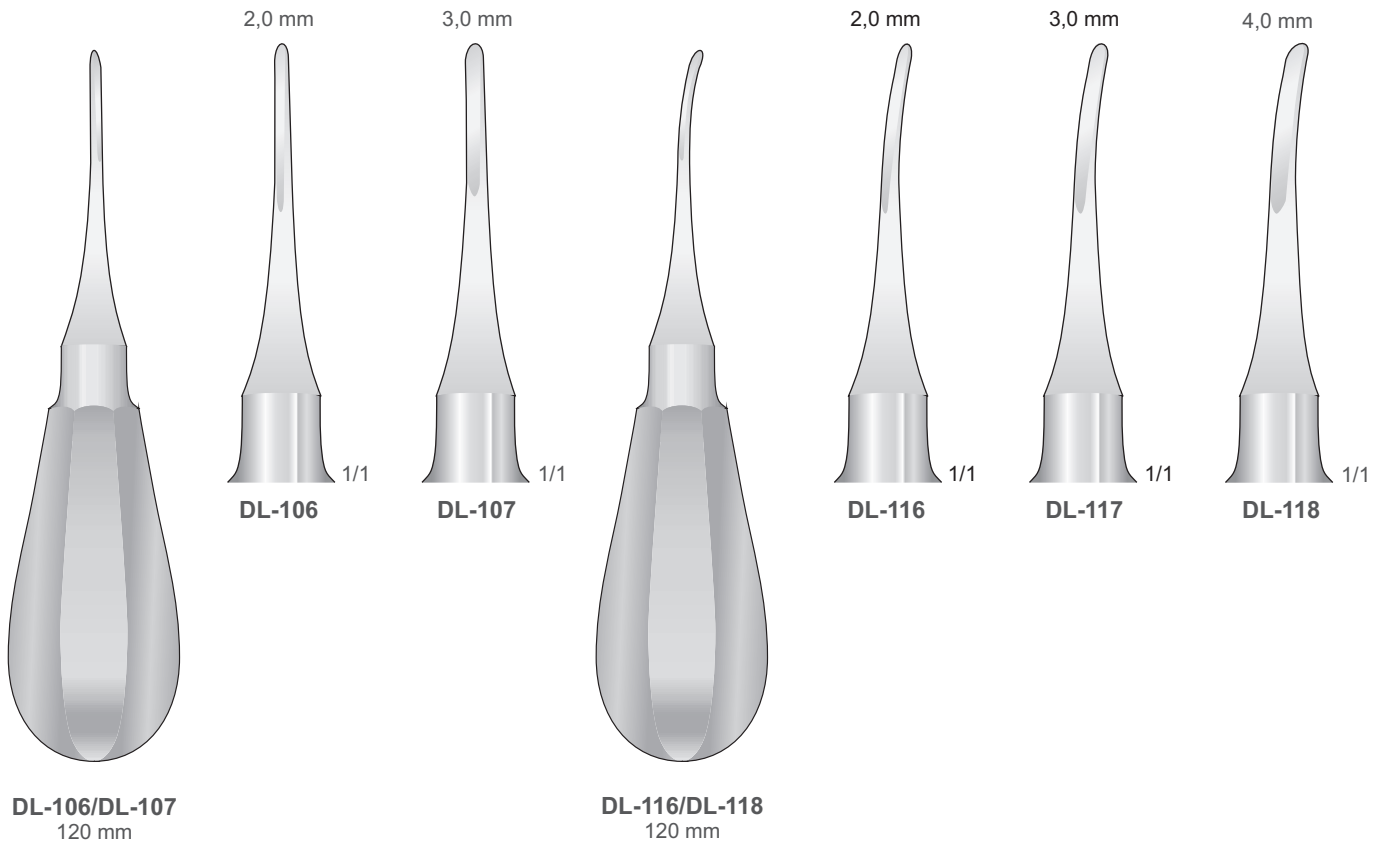

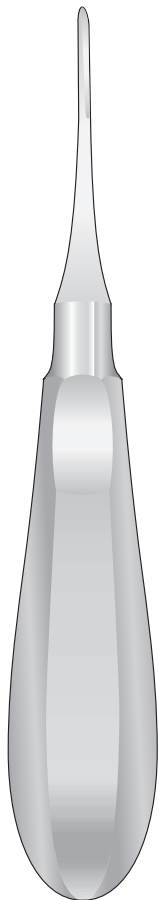
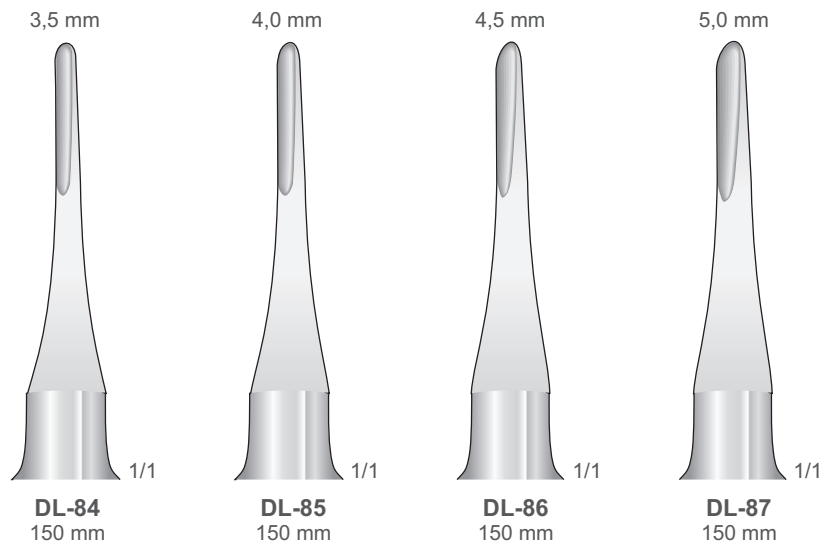
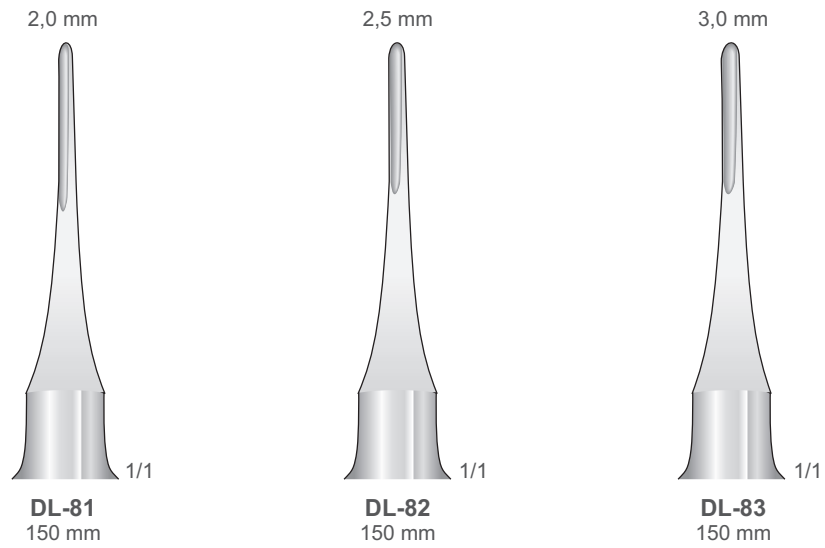

DL-81/DL-87
150 mm

Wurzelheber
Root Elevators
Leve per radici
Elevadores para raíces
Elevateurs à racines

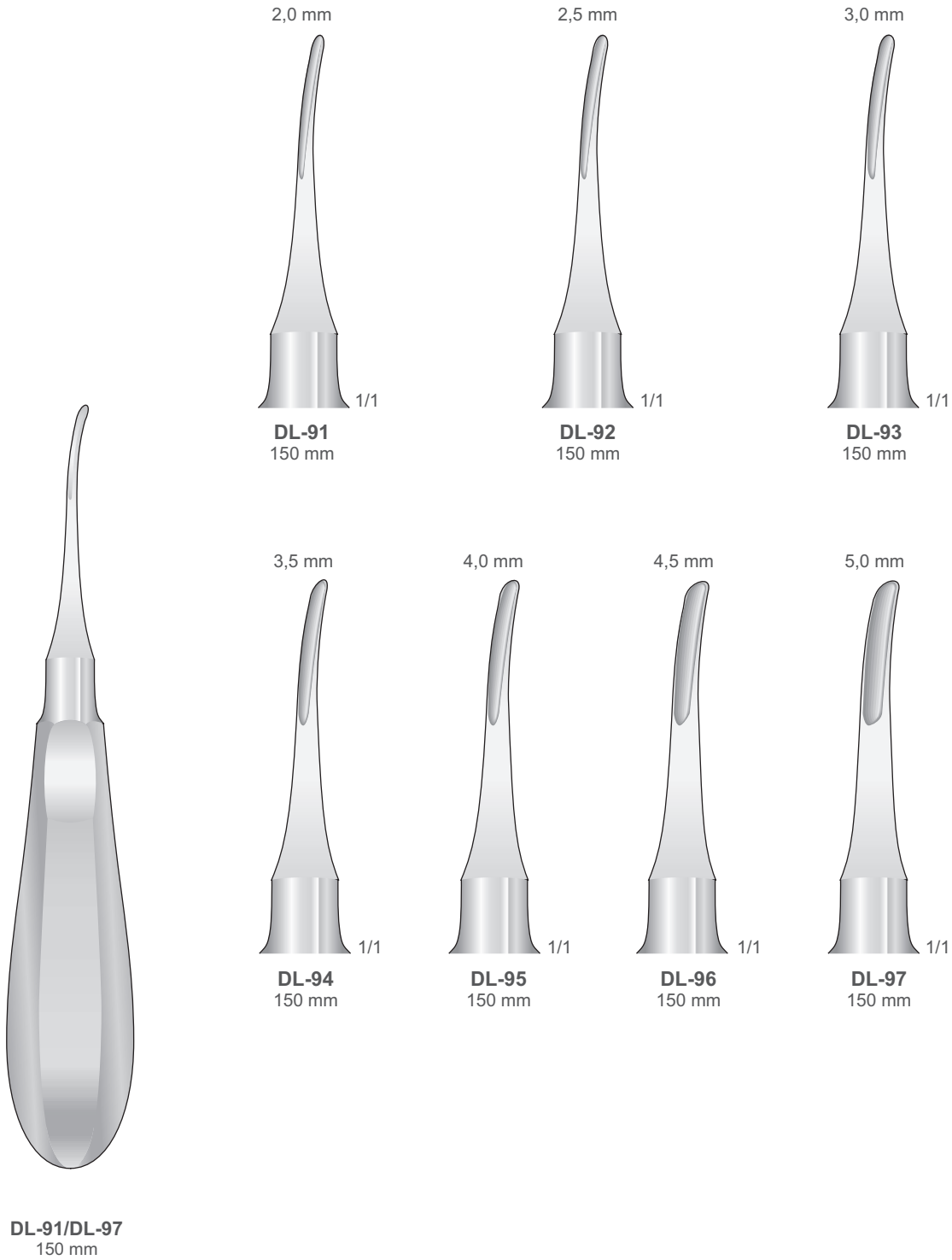

SMALL HANDLE

Luxierinstrumente | Luxating Elevators | Elevatori di lussazione | Elevadores de luxación | Élévateurs de luxation

ELEVATORS

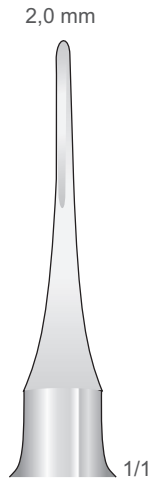

DL-102
150 mm

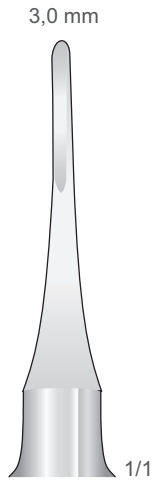

DL-103
150 mm

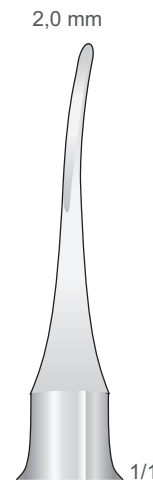

DL-112
150 mm

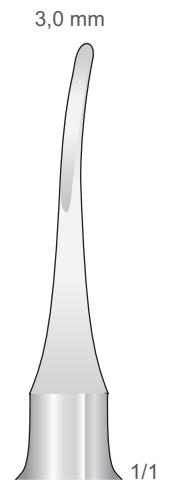

DL-113
150 mm

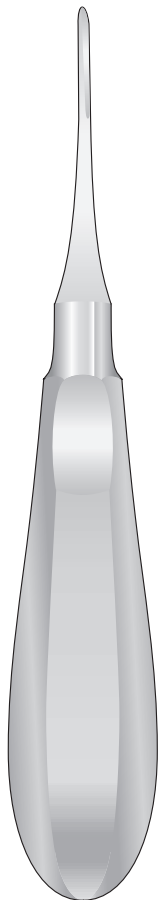

DL-102/DL-105
150 mm

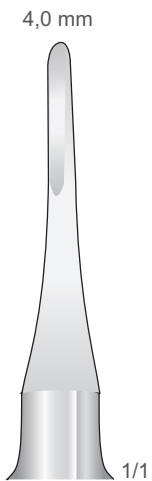

DL-104
150 mm

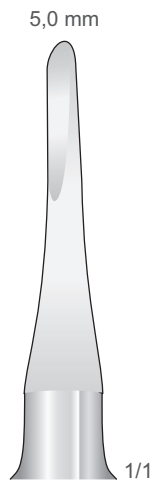

DL-105
150 mm

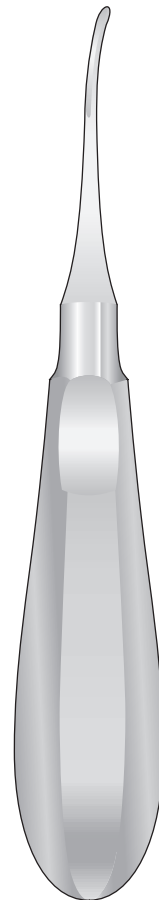

DL-112/DL-115
150 mm

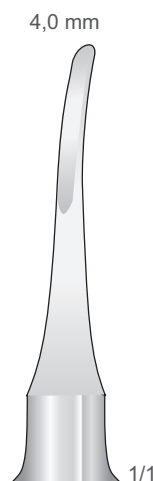

DL-114
150 mm

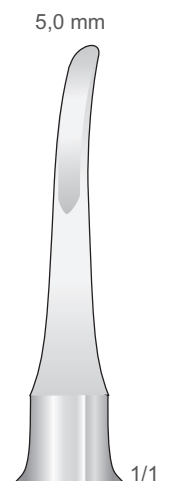

DL-115
150 mm

Wurzelheber
 Root Elevators
 Leve per radici
 Elevadores para raíces
 Elevateurs à racines

Wurzelspitzenheber
 Root fragment Elevators
 Leve per frammenti di radice
 Elevadores para fragmentos de raíces
 Elévateurs de fragments de racines

ELEVATORS

Gezant
 Serrated
 Dentellata
 Dentada
 Dentelé

HEIDBRINK
HE-2S
 Right # 2
 Root Tip Picks
 140 mm
SMALL HANDLE

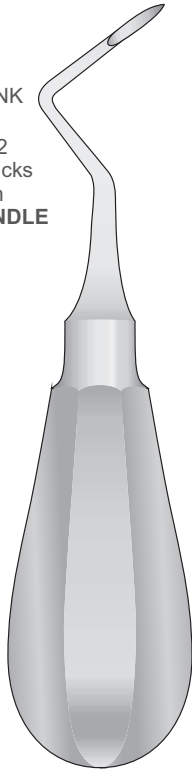

HEIDBRINK
HE-3S
 Left # 3
 Root Tip Picks
 140 mm
SMALL HANDLE

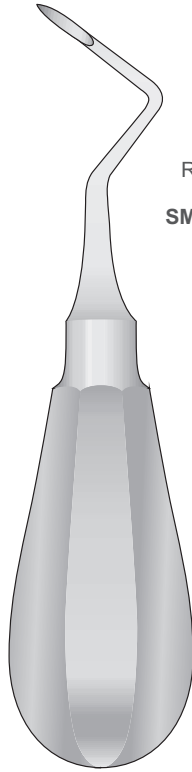

HEIDBRINK
HE-1
 Straight # 1
 Root Tip Picks
 140 mm



HEIDBRINK
HE-2
 Right # 2
 Root Tip Picks
 140 mm



HEIDBRINK
HE-3
 Left # 3
 Root Tip Picks
 140 mm

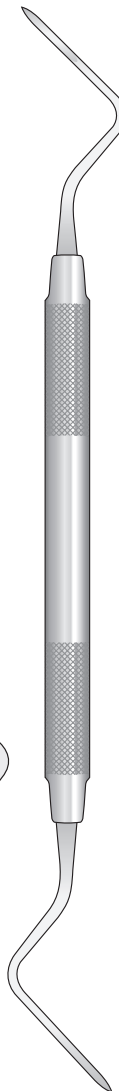
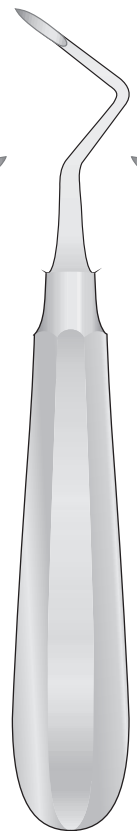

HEIDBRINK
725-1/2
 195 mm

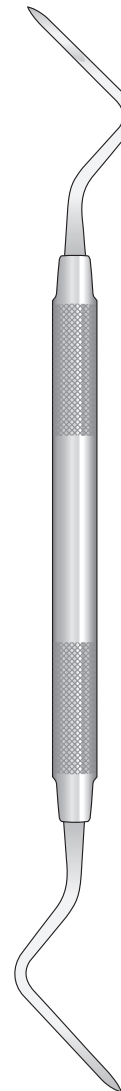

HEIDBRINK
725-3/4
 195 mm

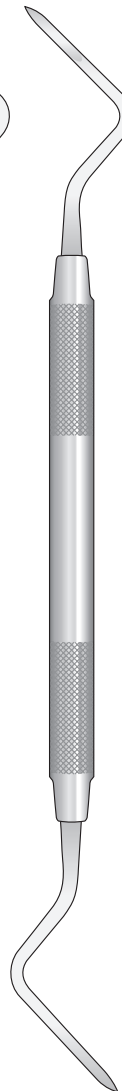

HEIDBRINK
725-5/6
 195 mm

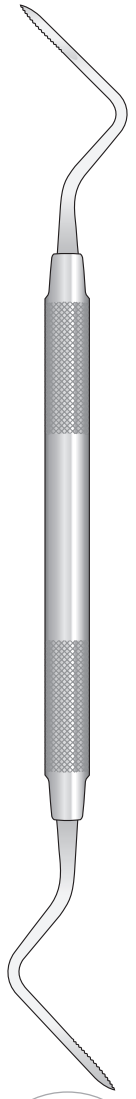

HEIDBRINK
725-3/4S
 195 mm

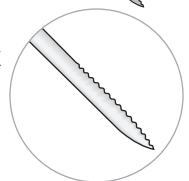

Extraktionshebel für obere Weisheitszähne
 Root Elevator for upper wisdom teeth
 Leva per estrazione dente del giudizio superiore
 Elevador de extracción de muelas del juicio superiores
 Élévateur à racines pour les dents de sagesse supérieures

Wurzelheber
 Root Elevators
 Leve per radici
 Elevadores para raíces
 Élevateurs de racines



ROSIN
DL-58
 160 mm



WARWICK-JAMES
DL-20
 160 mm

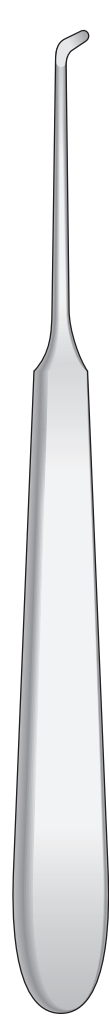

WARWICK-JAMES
DL-21
 155 mm

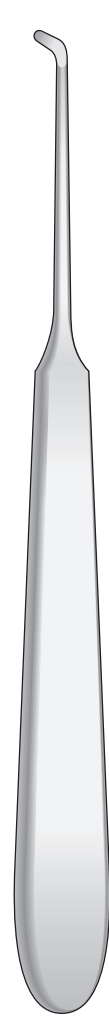

WARWICK-JAMES
DL-22
 155 mm

Obere
 Upper
 Superiori
 Superiores
 Supérieures

Untere
 Lower
 Inferiori
 Inferiores
 Inférieures

Untere
 Lower
 Inferiori
 Inferiores
 Inférieures

Eine seite gezahnt
 One side serrated
 Un lato dentellato
 Dentadura más lado
 Dentelure sur un côté

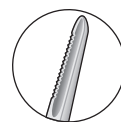
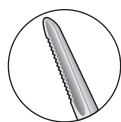
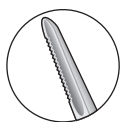

Fig. 94



DL-76
155 mm

Fig. 95



DL-77
155 mm

Fig. 100L



DL-78
155 mm

Fig. 100R



DL-79
155 mm

Gezant
Serrated
Dentellate
Dentadas
Dentelé

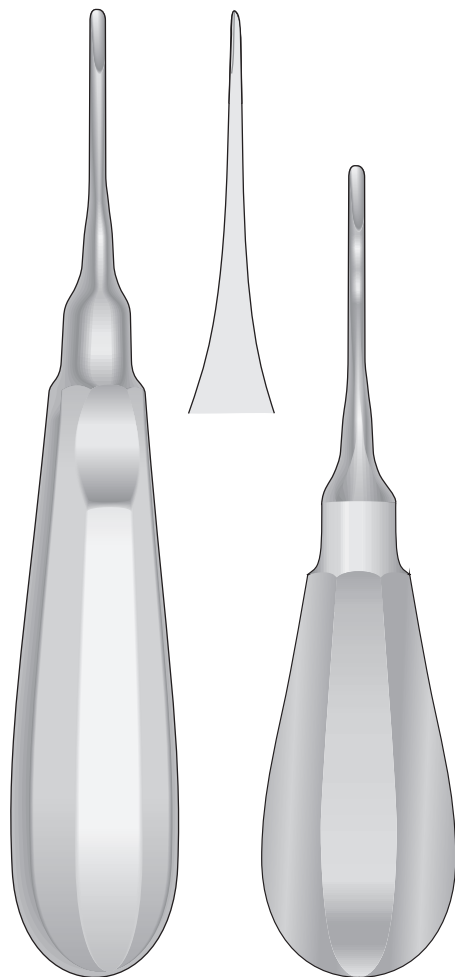

APEXO
DL-34S
301
155 mm

APEXO
DL-34S
301
130 mm
SMALL HANDLE

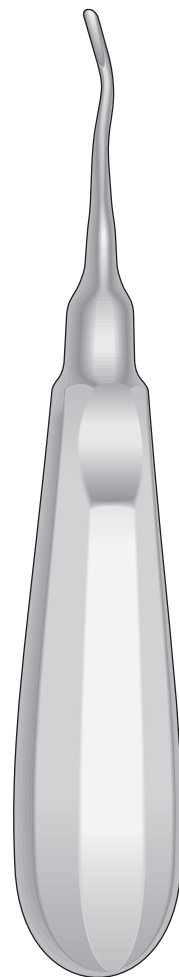

APEXO
DL-35/DL-36
155 mm

Fig. 302

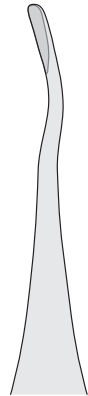

DL-35

Fig. 303

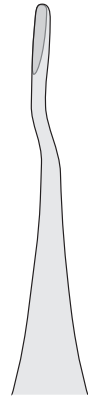

DL-36

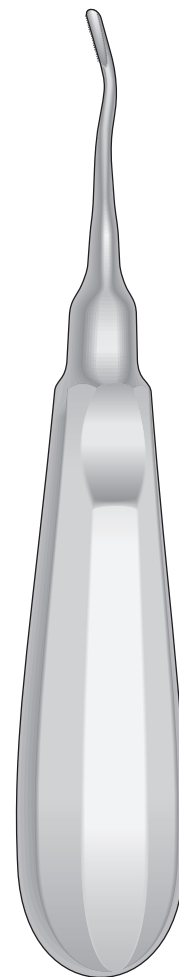

APEXO
DL-37/DL-38
155 mm

Fig. 77L

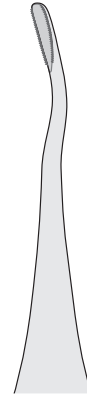

DL-37

Fig. 77R

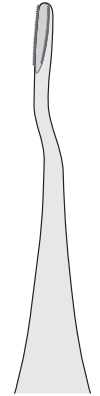

DL-38

Wurzelheber
Root Elevators
Leve per radici
Elevadores para raíces
Elevateurs à racines

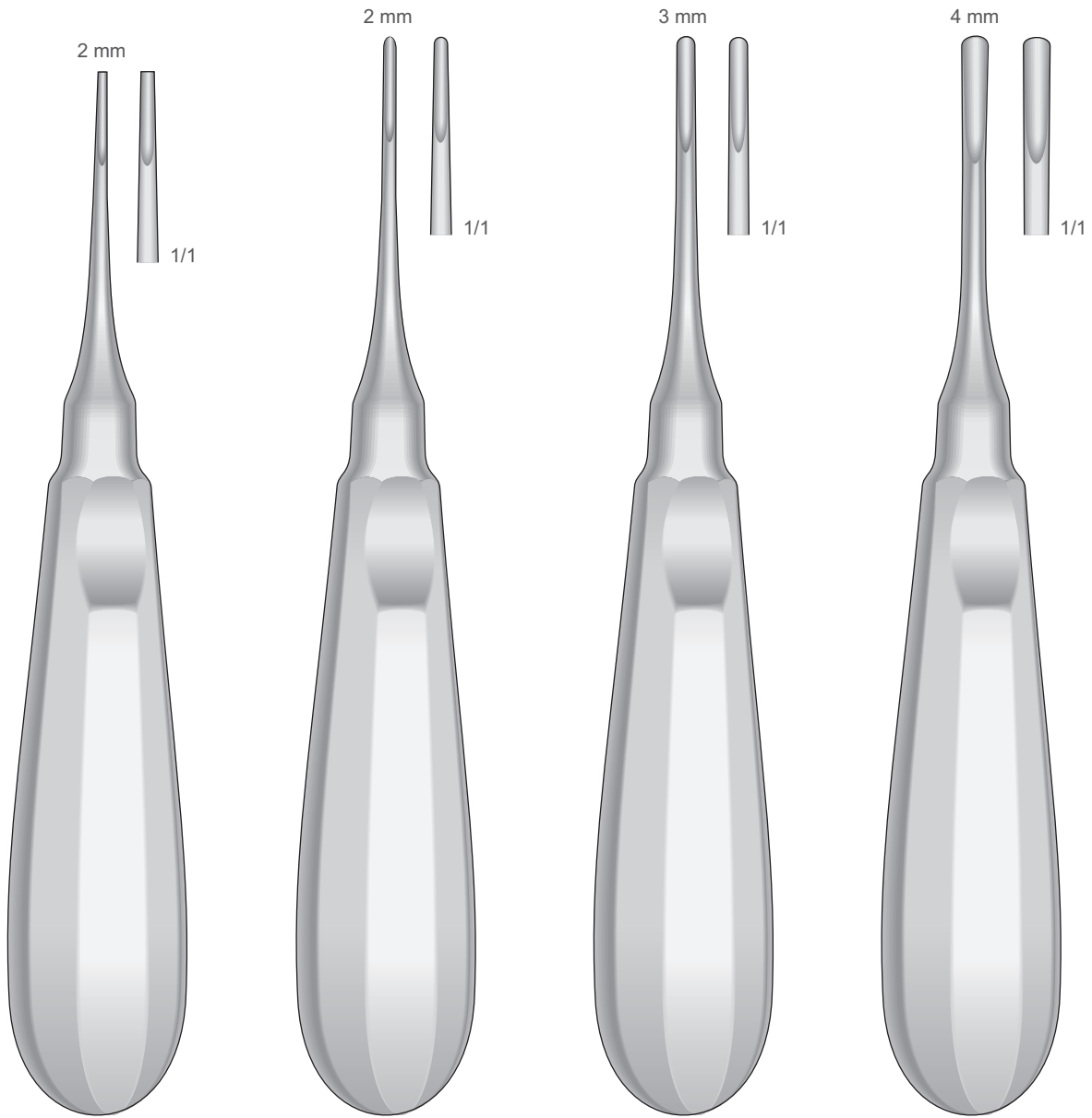

BEIN-1T
150 mm

BEIN-2
155 mm

BEIN-3
155 mm

BEIN-4
155 mm

Wurzelheber
Root Elevators
Leve per radici
Elevadores para raíces
Elevateurs à racines

ELEVATORS

FLOHR-1
140 mm

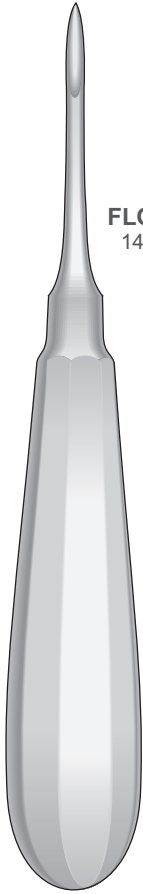

FLOHR-2
150 mm

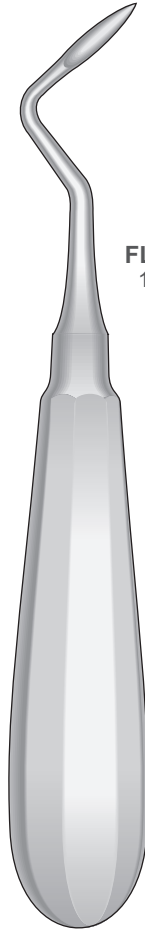

FLOHR-3
150 mm



APICAL-1
155 mm

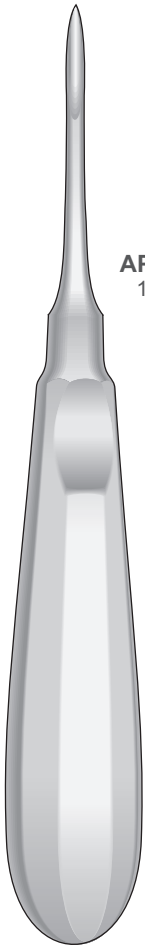

APICAL-4
155 mm

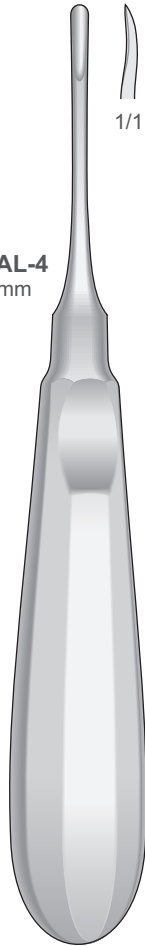

APICAL-2
155 mm

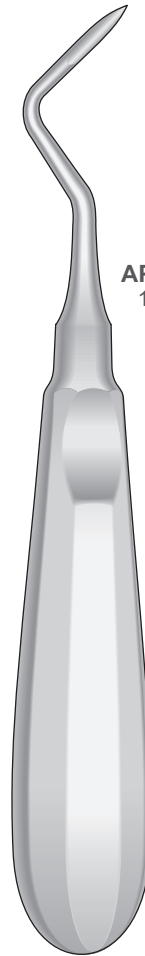

APICAL-3
155 mm

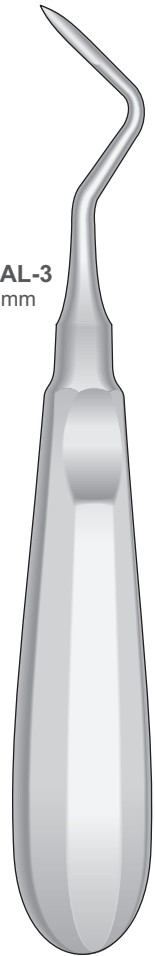

Wurzelheber
 Root Elevators
 Leve per radici
 Elevadores para raíces
 Elevateurs à racines

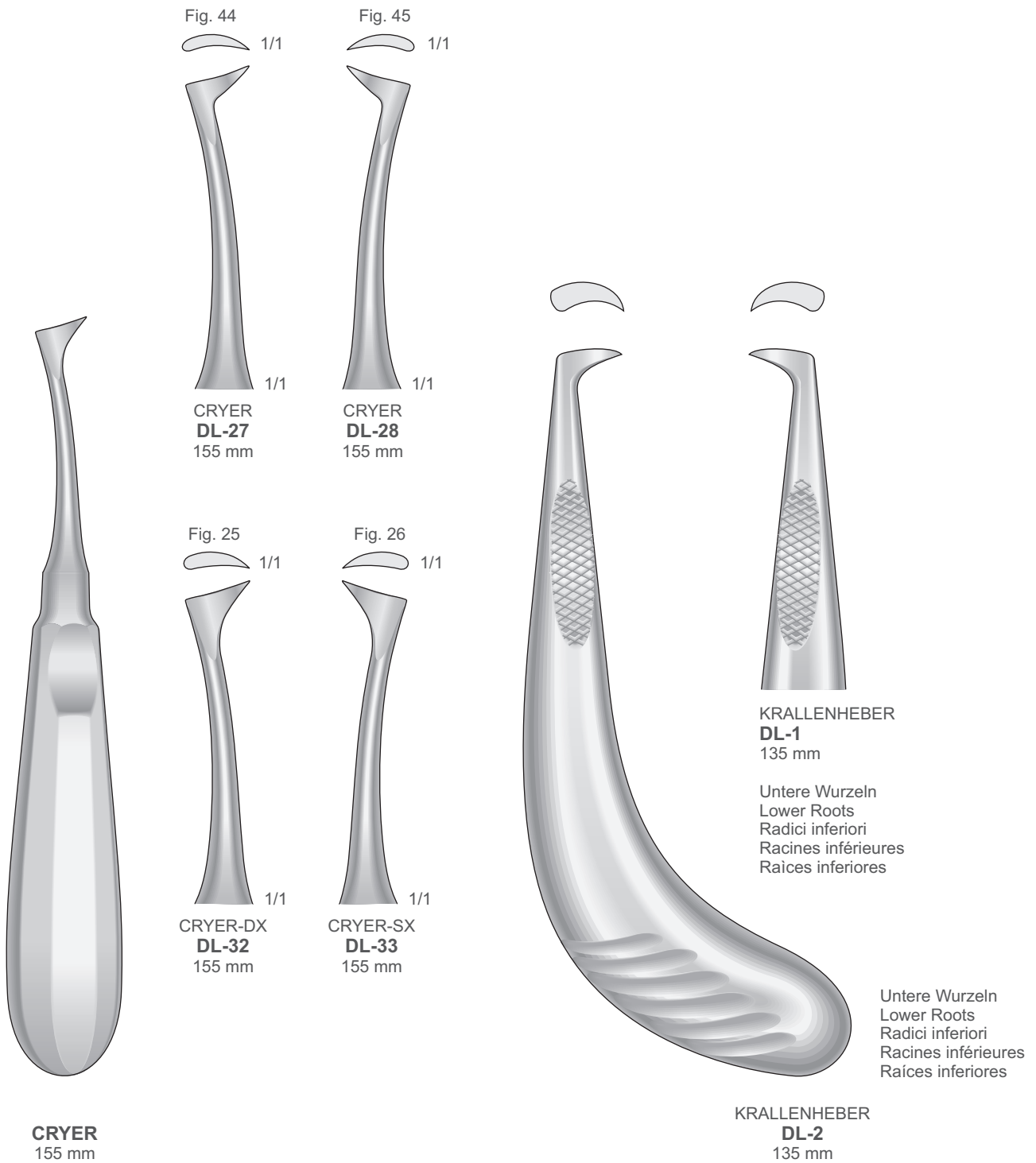

Wurzelheber
 Root Elevators
 Leve per radici
 Elevadores para raíces
 Elevateurs à racines

ELEVATORS

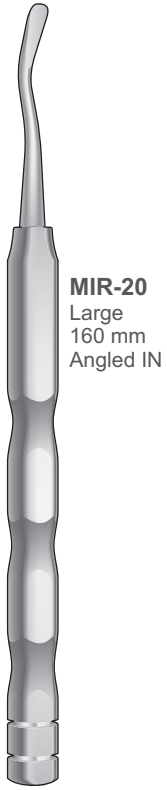

MIR-20
 Large
 160 mm
 Angled IN

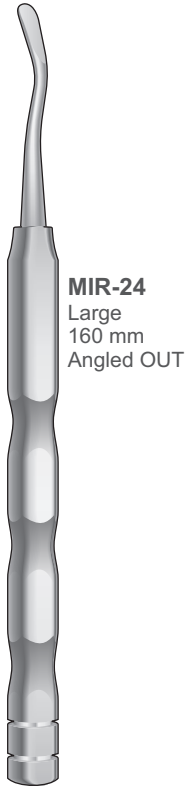

MIR-24
 Large
 160 mm
 Angled OUT

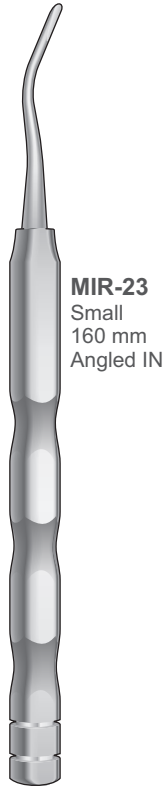

MIR-23
 Small
 160 mm
 Angled IN

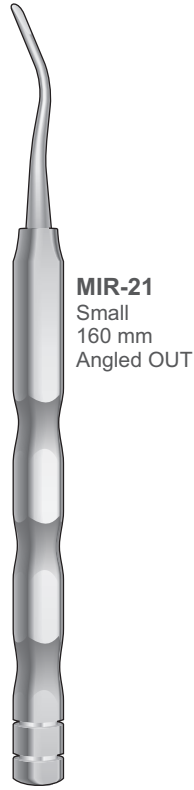

MIR-21
 Small
 160 mm
 Angled OUT

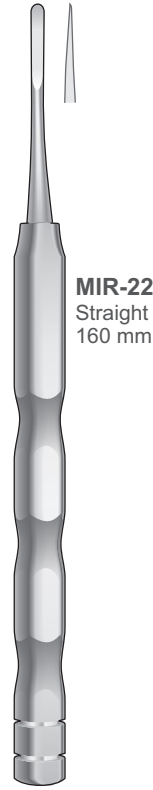

MIR-22
 Straight
 160 mm

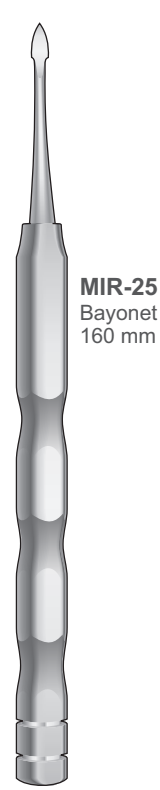

MIR-25
 Bayonet
 160 mm

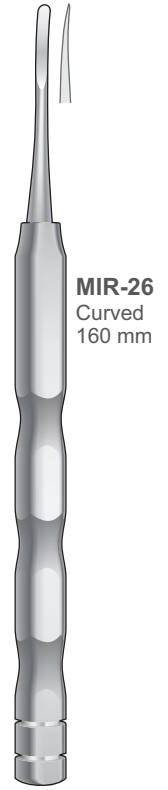

MIR-26
 Curved
 160 mm

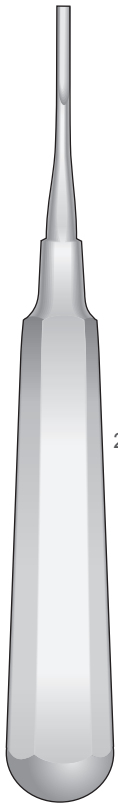

COUPLAND CO-1
 155 mm

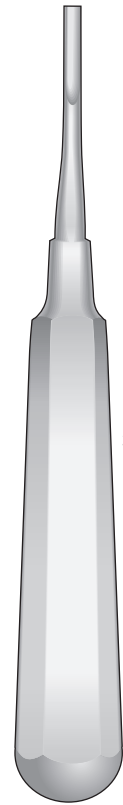
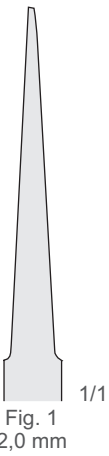

COUPLAND CO-2
 155 mm

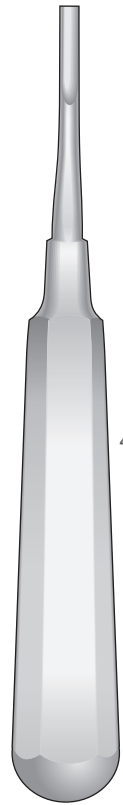
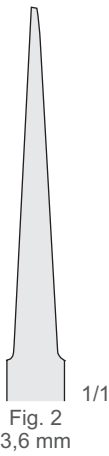

COUPLAND CO-3
 155 mm

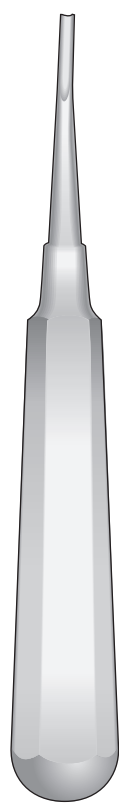
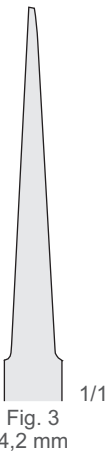

COUPLAND CO-11
 155 mm

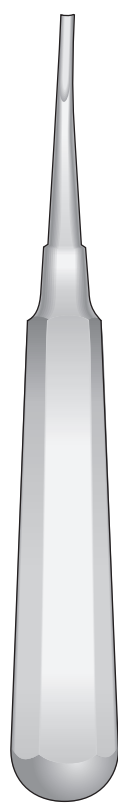
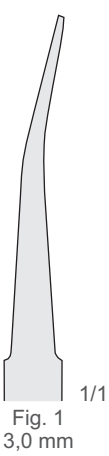

COUPLAND CO-12
 155 mm

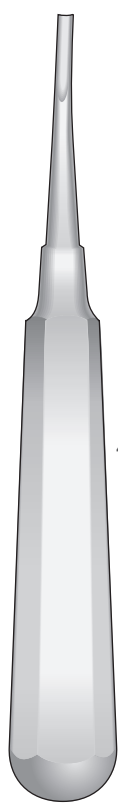
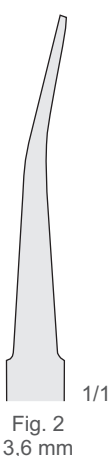

COUPLAND CO-13
 155 mm

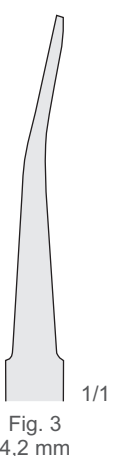

Wurzelheber
Root Elevators
Leve per radici
Elevadores para raíces
Elevateurs à racines

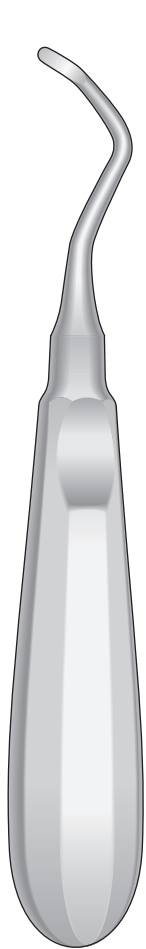

MILLER-APEXO
MI-10/MI-11
155 mm

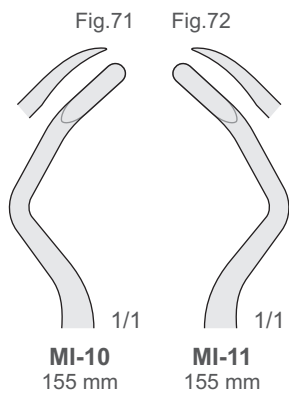

MI-10
155 mm

MI-11
155 mm

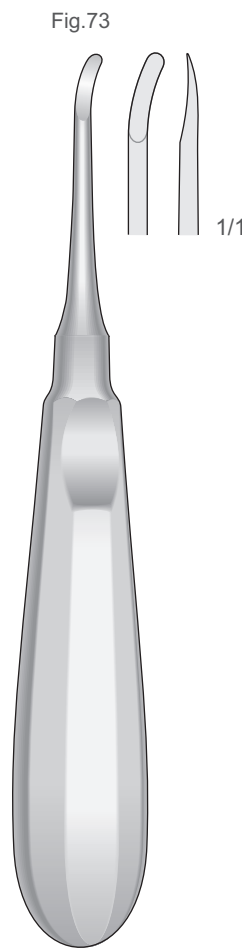

MILLER-APEXO
MI-12
155 mm

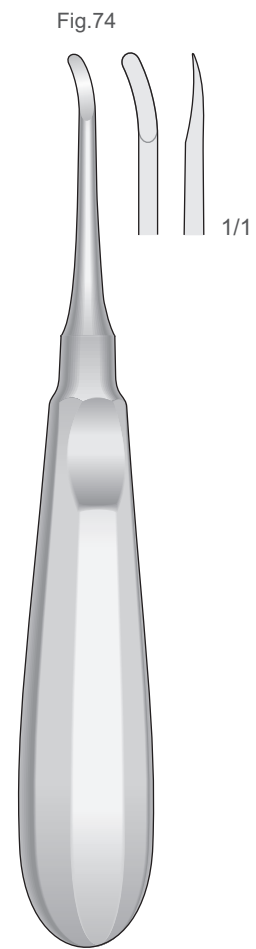

MILLER-APEXO
MI-13
155 mm

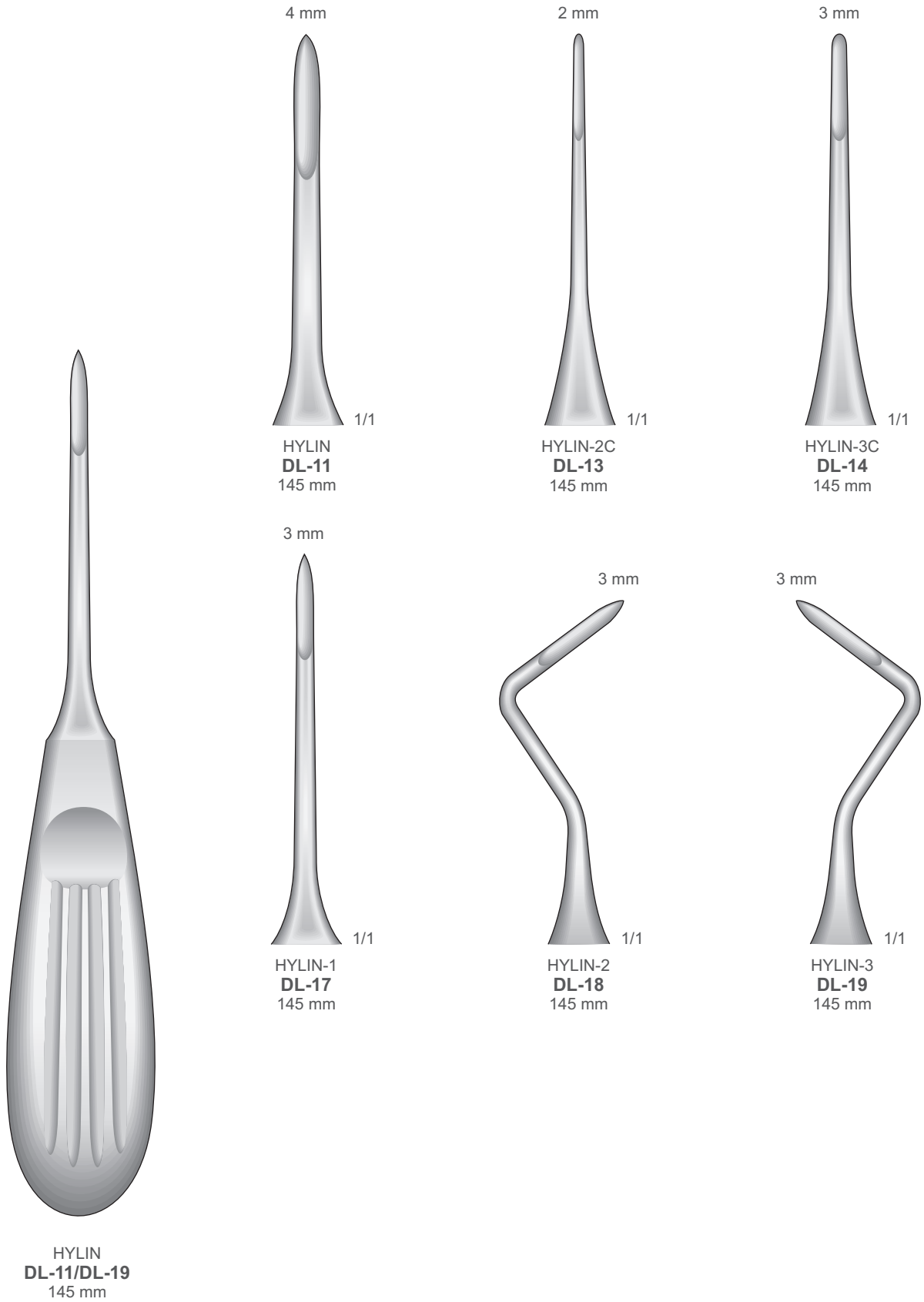

Wurzelheber
Root Elevators
Leve per radici
Elevadores para raíces
Elevateurs à racines

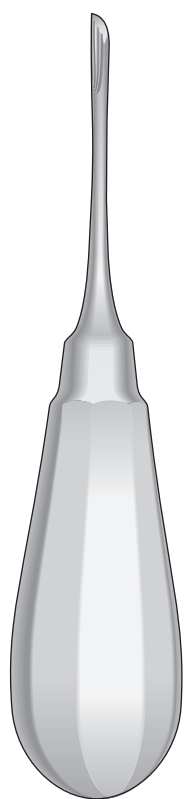

**KOPP
DL-30**
130 mm

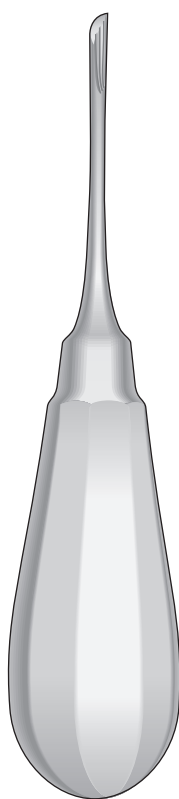

**KOPP
DL-31**
130 mm

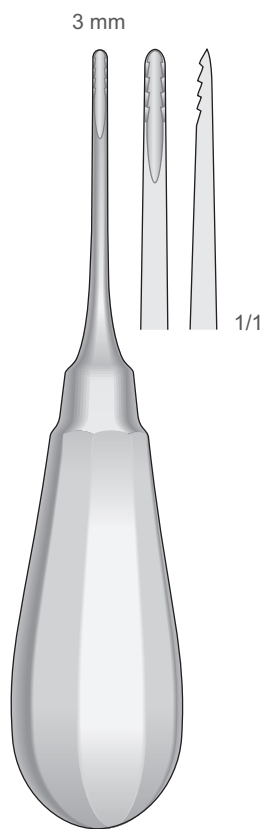

BEIN-1Z
130 mm

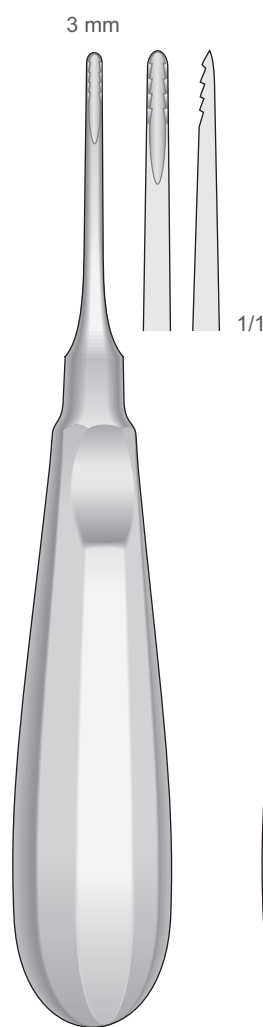

BEIN-2Z
155 mm

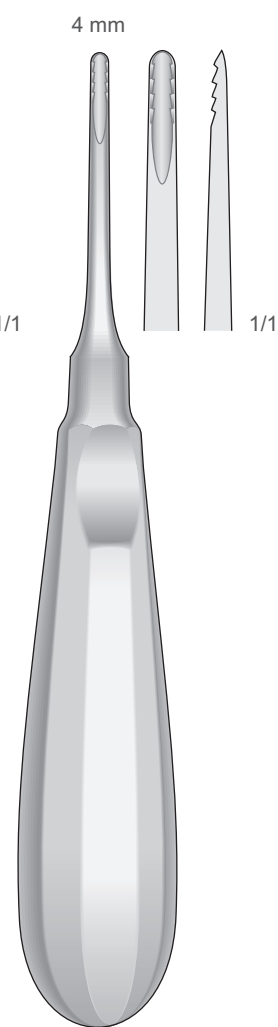

**LINDO-LEVIEN
BEIN-4Z**
155 mm

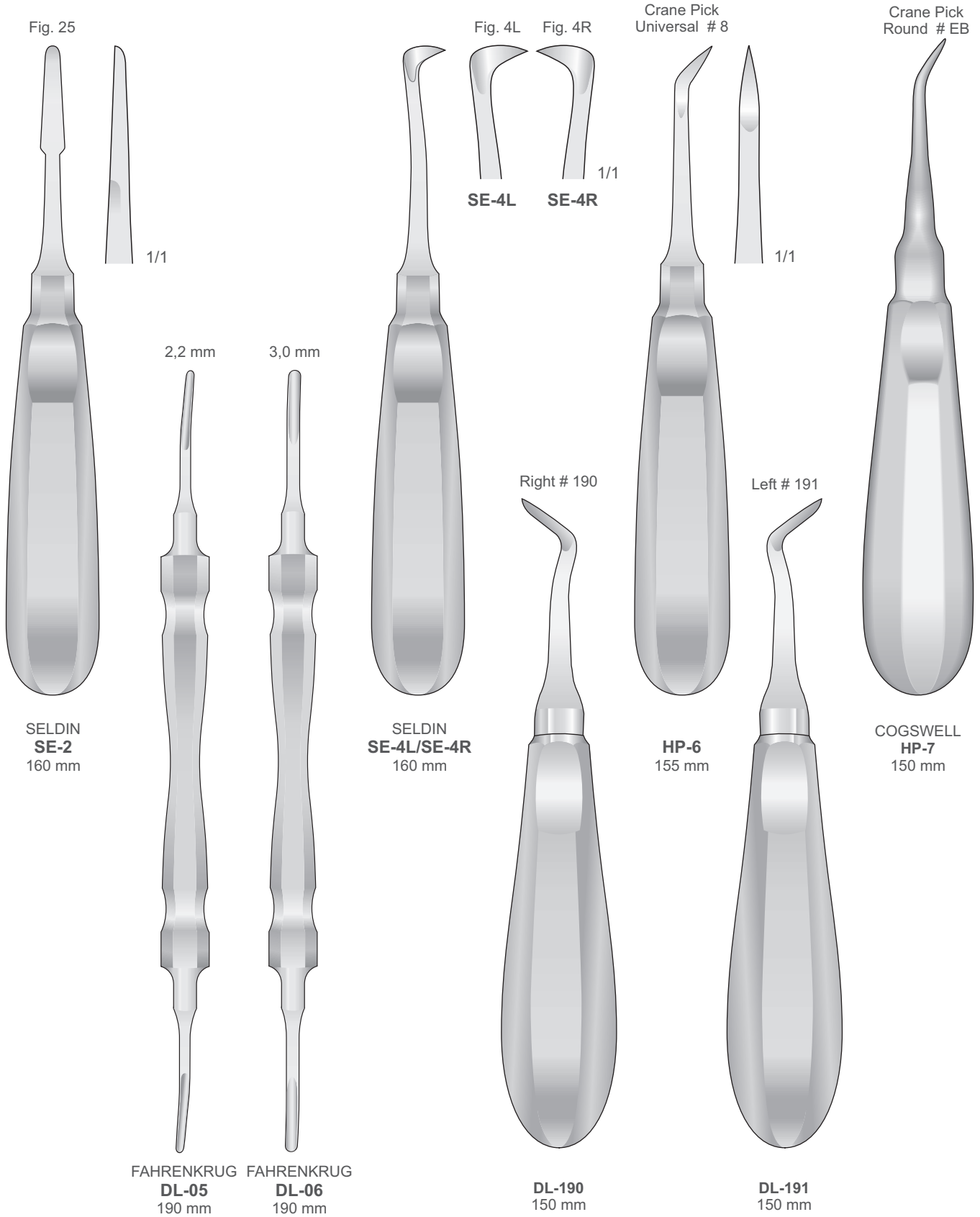

Wurzelheber
Root Elevators
Leve per radici
Elevadores para raíces
Elevateurs à racines

SELDIN
DL-48
304W
155 mm

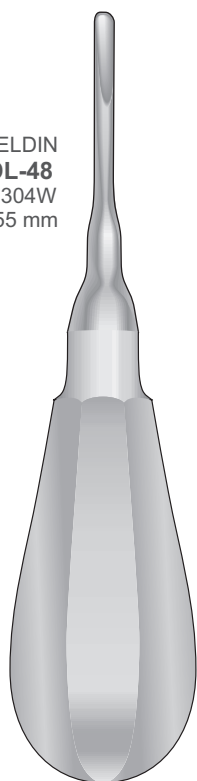

SELDIN
DL-49
34S
155 mm

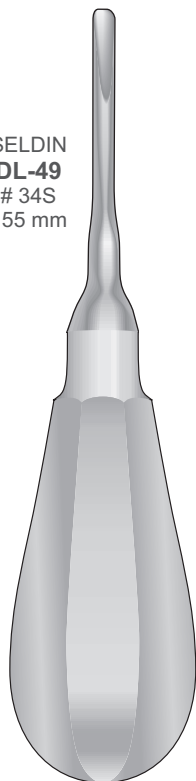

304W

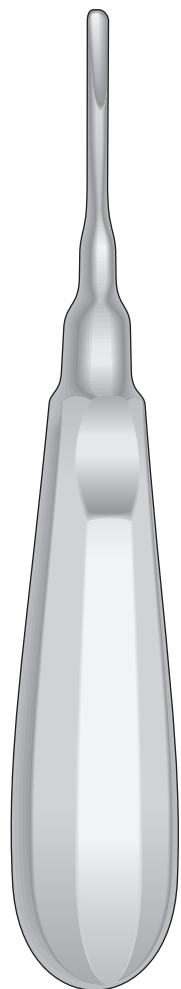

SELDIN
DL-48
304W
155 mm

34S

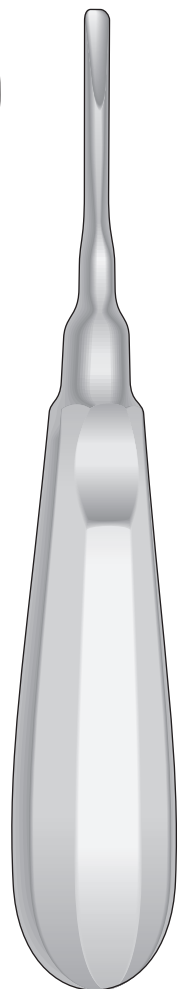

SELDIN
DL-49
34S
155 mm

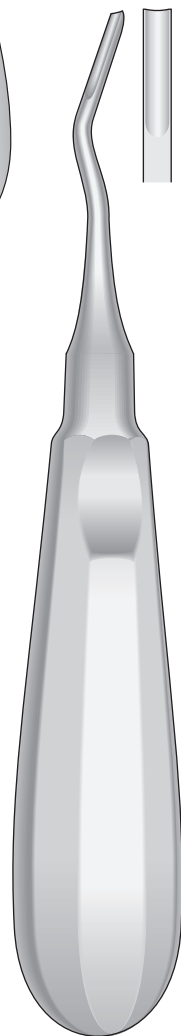
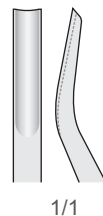

DL-54
160 mm

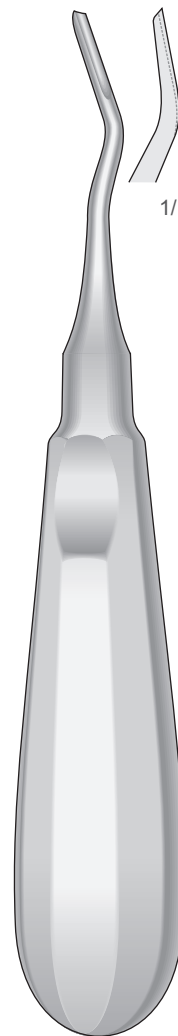

DL-55
160 mm

Fig. 6

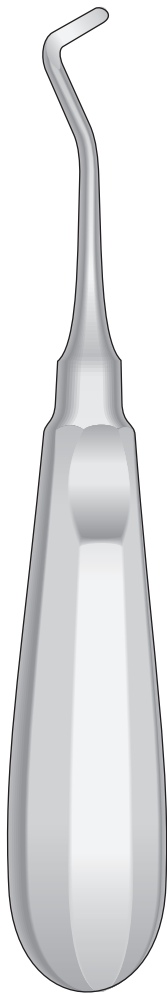

POTT
DL-98
160 mm

Fig. 7

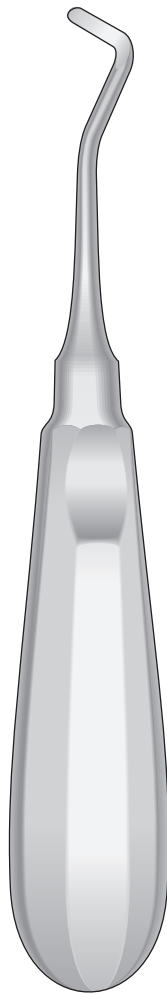

POTT
DL-99
160 mm

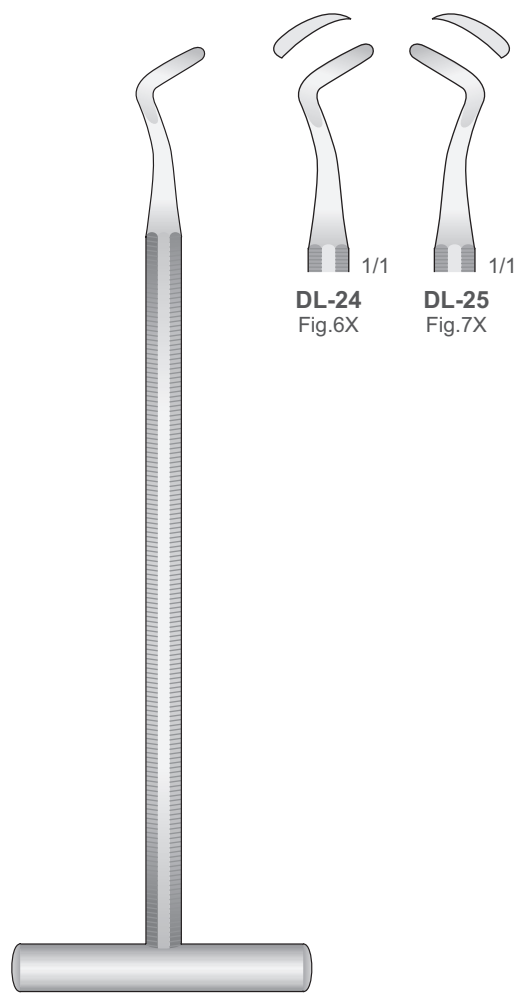

POTT
DL-24/DL-25
155 mm

Wurzelheber
 Root Elevators
 Leve per radici
 Elevadores para raíces
 Elevateurs à racines

Syndesmotome
 Syndesmotomes
 Sindesmotomi
 Syndesmôtomos
 Syndesmotomes

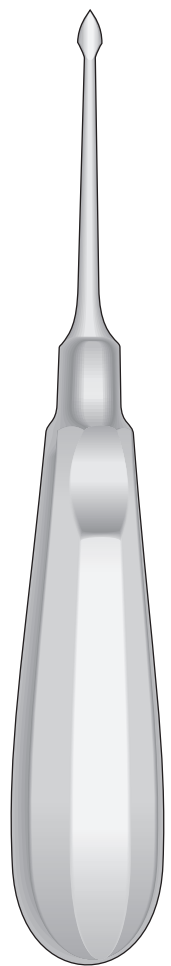

BERNARD
DL-73/DL-124

Gerade
 Straight
 Diritto
 Rectas
 Droites

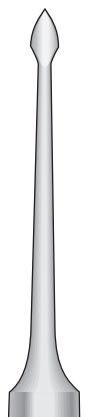

BERNARD
DL-73
 150 mm

Links
 Left
 Sinistra
 A la izquierda
 À gauche

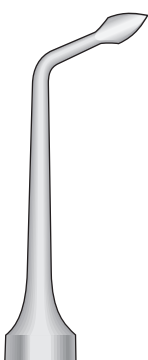

BERNARD
DL-74
 140 mm

Rechts
 Right
 Destro
 A la derecha
 À droite

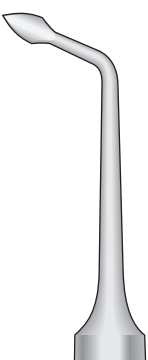

BERNARD
DL-75
 140 mm

Bajonett - Bayonet
 Baionetta - Bayoneta
 Baionnette

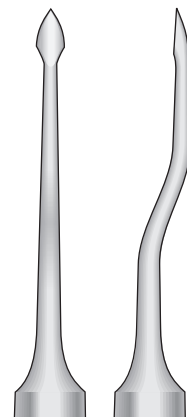

BERNARD
DL-123
 150 mm

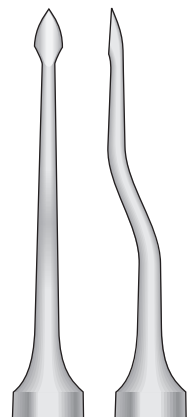

BERNARD
DL-124
 150 mm

Wurzelheber
 Root Elevators
 Leve per radici
 Elevadores para raíces
 Elevateurs à racines

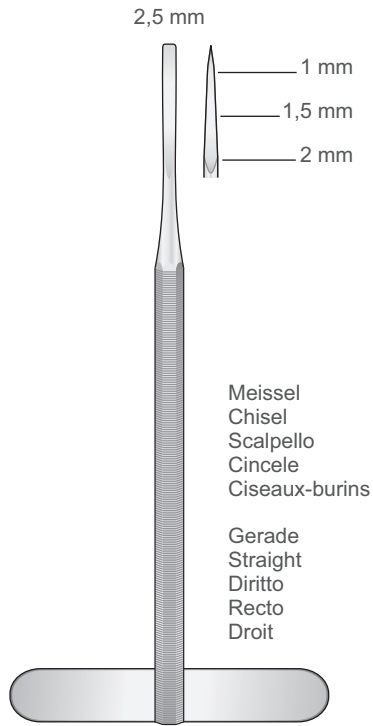

DL-88
130 mm

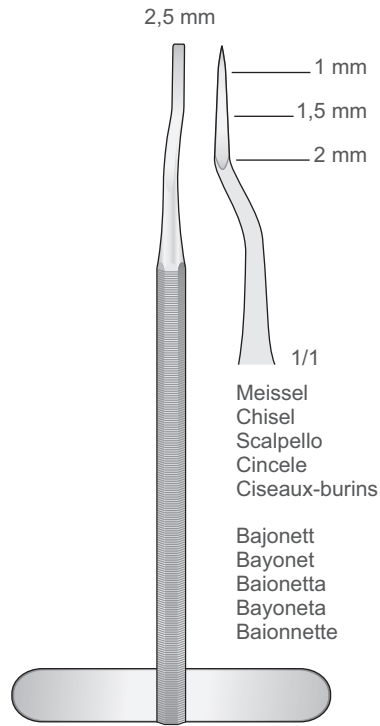

DL-89
130 mm

Syndesmotome
 Syndesmotomes
 Sindesmotomo
 Syndesmôtomos
 Syndesmotomes

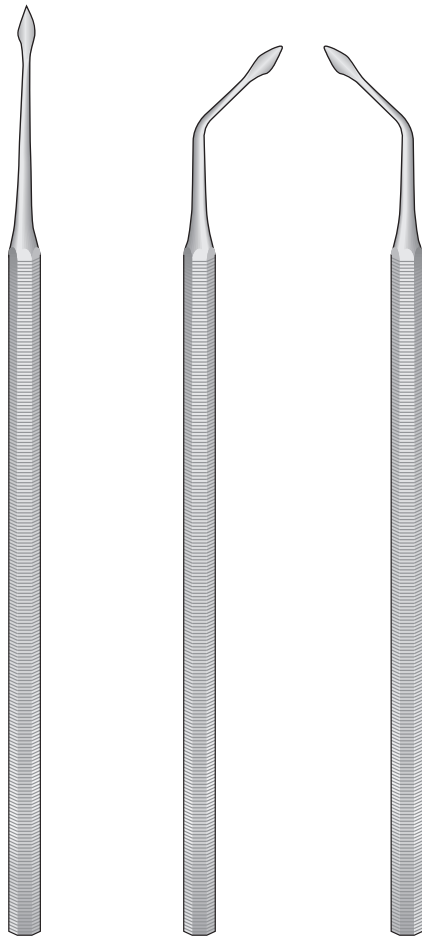

DL-63
150 mm

DL-62
150 mm

DL-61
150 mm

Raspatorien
 Raspatories
 Scollaperiosteo
 Legras
 Rugines

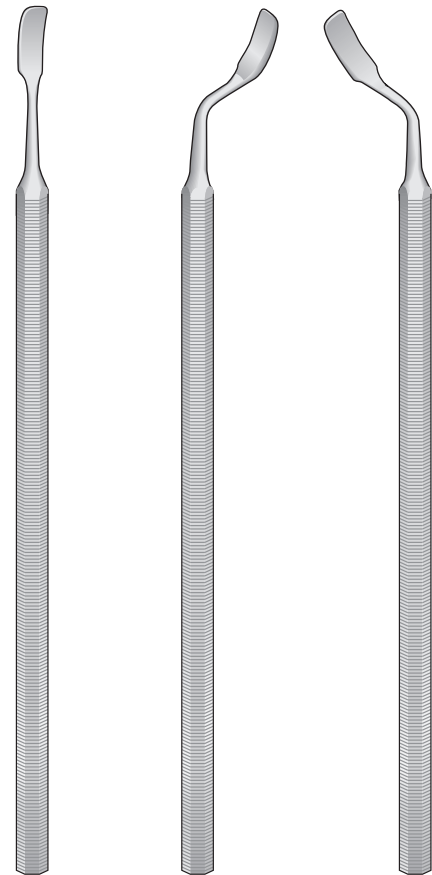

DL-59
150 mm

DL-68
150 mm

DL-69
150 mm

Wurzelheber
Root Elevators
Leve per radici
Elevadores para raíces
Elevateurs à racines

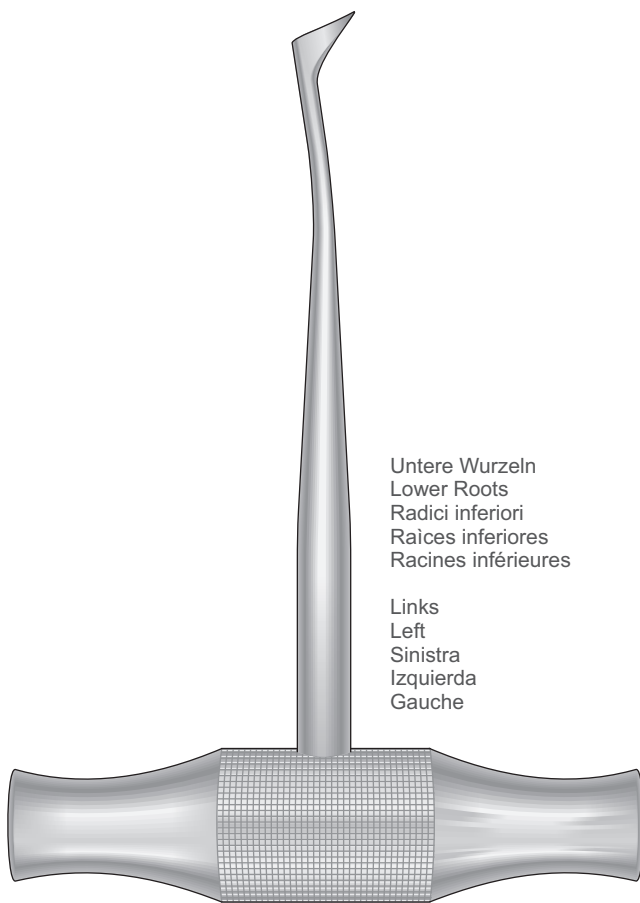

Untere Wurzeln
Lower Roots
Radici inferiori
Raíces inferiores
Racines inférieures

Links
Left
Sinistra
Izquierda
Gauche

WINTER
DL-100
Fig.1

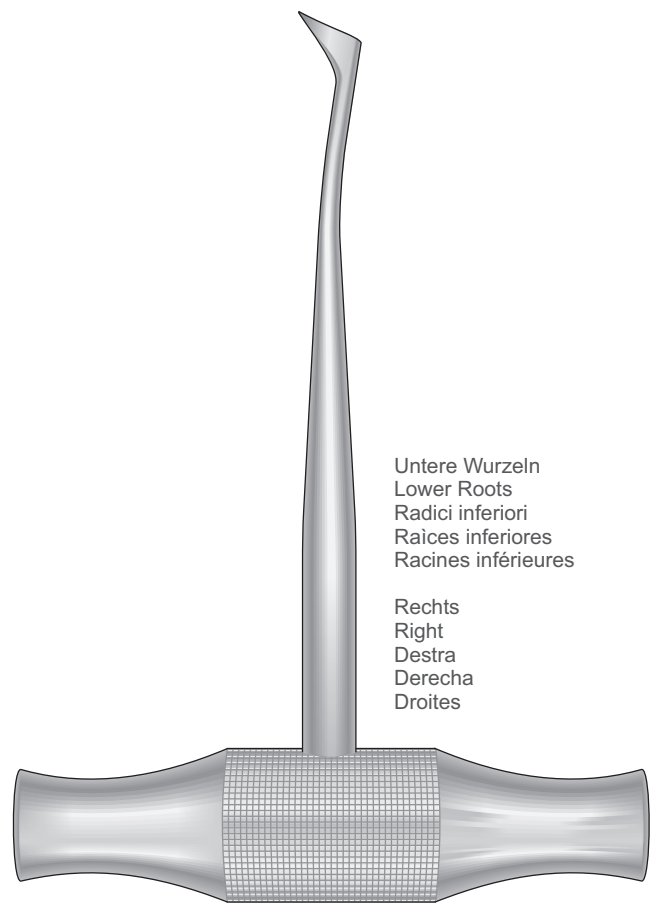

Untere Wurzeln
Lower Roots
Radici inferiori
Raíces inferiores
Racines inférieures

Rechts
Right
Destra
Derecha
Droites

WINTER
DL-101
Fig.2

Fig. 1L



WINTER
DL-64
120 mm

Fig. 1R



WINTER
DL-65
120 mm

Fig. 14L



WINTER
DL-66
125 mm

Fig. 14R



WINTER
DL-67
125 mm

Wurzelheber
 Root Elevators
 Leve per radici
 Elevadores para raíces
 Elevateurs à racines

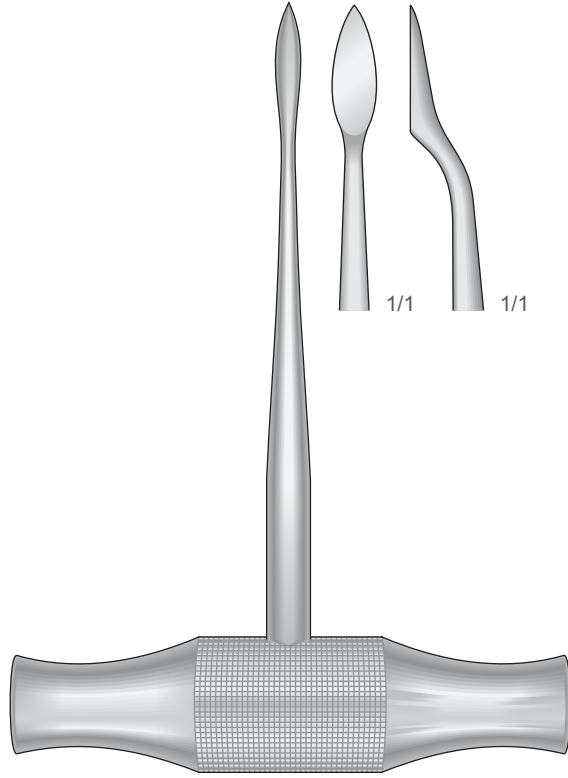

LECLUSE
DL-90
 130 mm

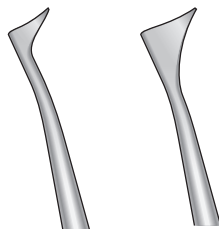

BARRY
DL-110
 Fig. 322

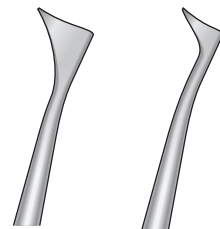

BARRY
DL-111
 Fig. 323

Links
 Left
 Sinistra
 Izquierda
 Gauche

Rechts
 Right
 Destra
 Derecha
 Droites

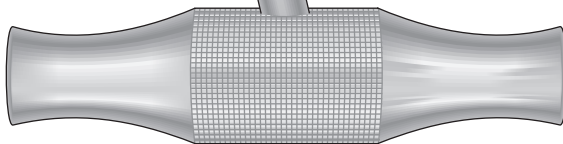

BARRY
DL-108 Fig. 320
 115 mm

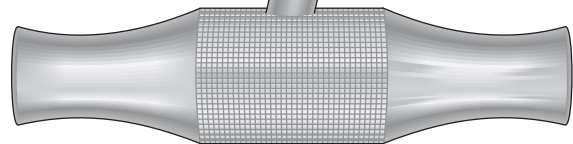

BARRY
DL-109 Fig. 321
 115 mm

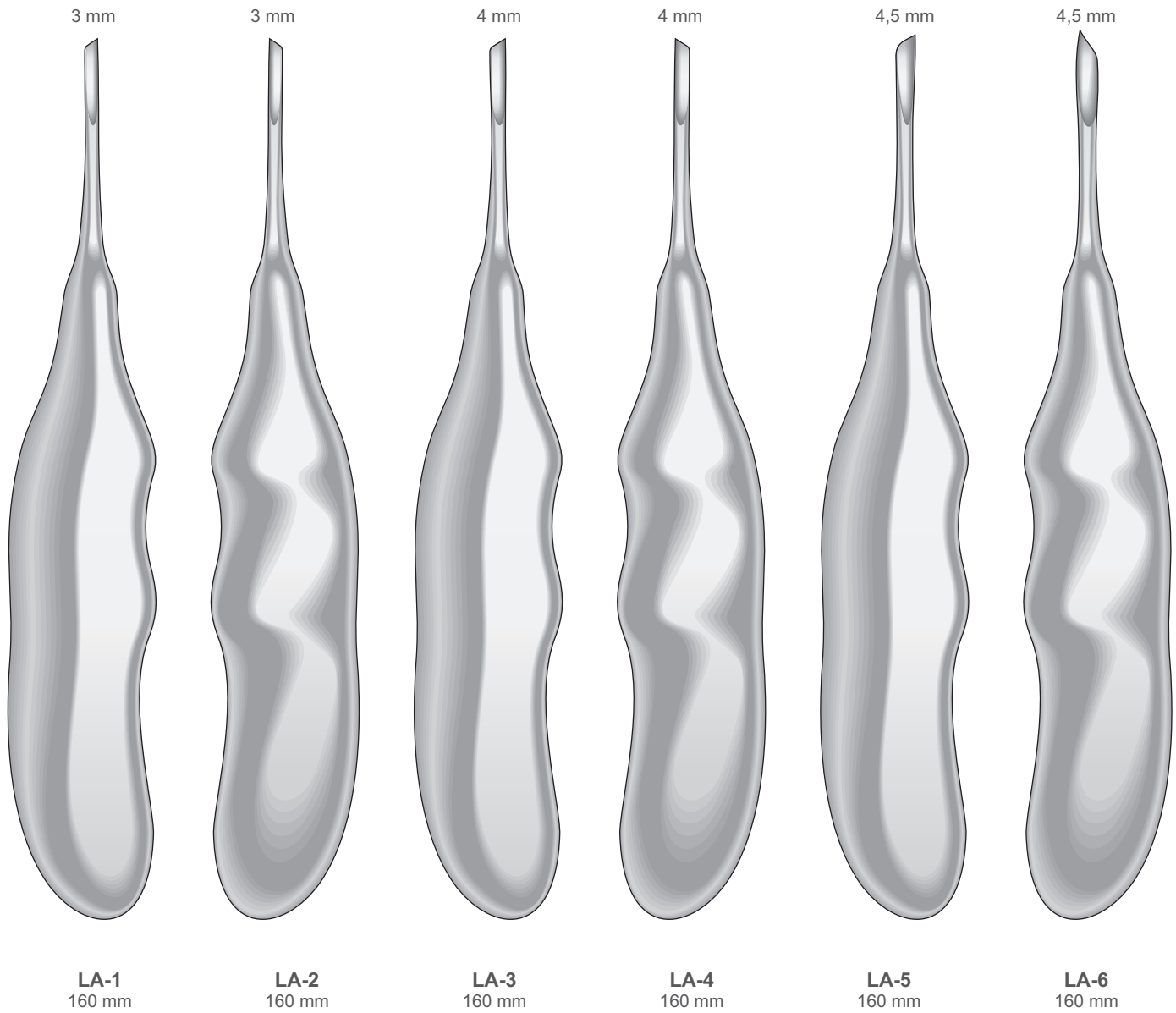

Wurzelheber
Root Elevators
Leve per radici
Elevadores para raíces
Elevateurs à racines



LA-7
160 mm



LA-8
160 mm



LA-9
160 mm



LA-10
160 mm

2 mm



LA-11
155 mm

3 mm



LA-12
155 mm

4 mm



LA-13
155 mm



LA-16
160 mm



LA-17
160 mm

Wurzelheber
Root Elevators
Leve per radici
Elevadores para raíces
Elevateurs à racines



LA-20
160 mm



LA-21
160 mm



LA-22
160 mm



LA-23
160 mm

Syndesmotome
Syndesmotomes
Sindesmotomo
Syndesmòtomos
Syndesmotomes



Massiv
Solid
Manico
Pieno
Massif

CHOMPRET
CH-11
150 mm



Massiv
Solid
Manico
Pieno
Massif

CHOMPRET
CH-12
150 mm



Massiv
Solid
Manico
Pieno
Massif

CHOMPRET
CH-13
150 mm



Massiv
Solid
Manico
Pieno
Massif

CHOMPRET
CH-14
145 mm



CHOMPRET
CH-1
165 mm



CHOMPRET
CH-2
165 mm



CHOMPRET
CH-3
165 mm



CHOMPRET
CH-4
160 mm

Zahnreiniger - Periotome
 Scalers - Periotomes
 Ablatori di tartaro - Periotomi
 Limpiadores de sarro - Periotomos
 Detartreurs - Périotomes

MORSE - SCALERS

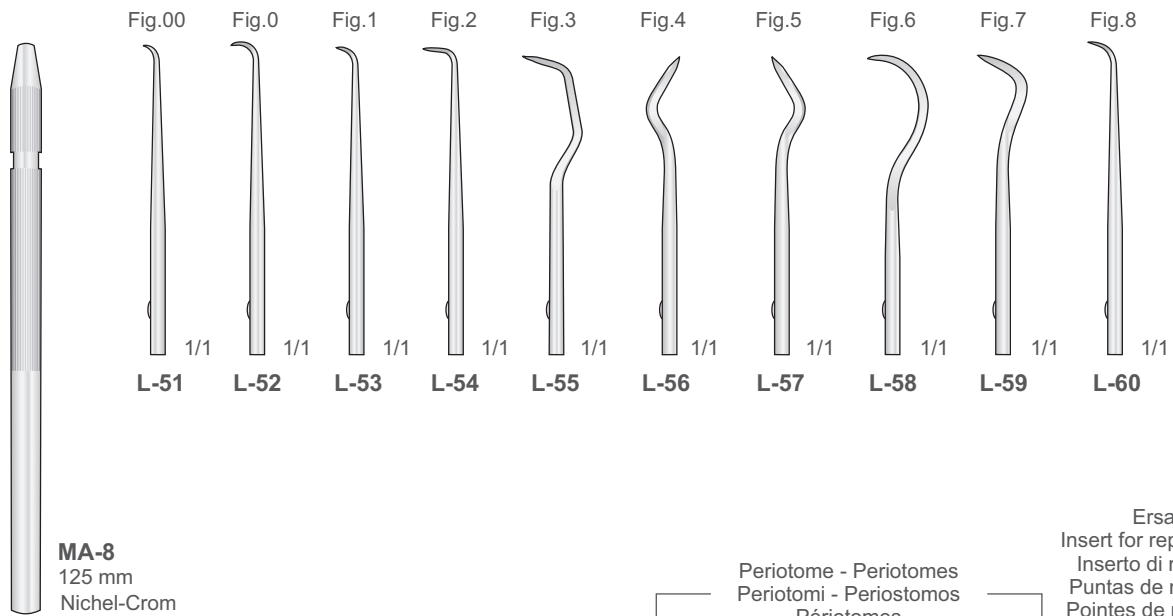

Ersatz
 Insert for replacement
 Inserto di ricambio
 Puntas de recambio
 Pointes de rechange

Periotome - Periotomes
 Periotomi - Periotomos
 Périotomes

Periotome - Periotomes
 Periotomi - Periotomos
 Périotomes

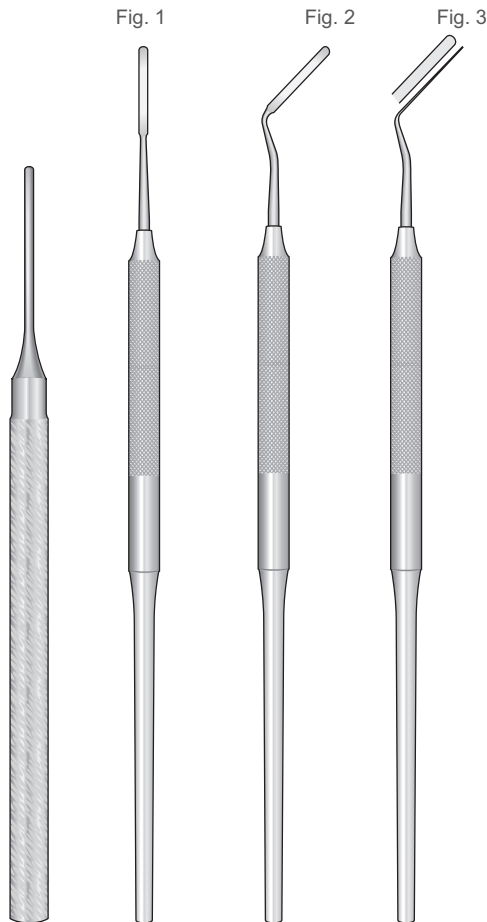

MIR-09 140 mm
MC-11 160 mm
MC-12 160 mm
MC-13 160 mm

Fig. 1 Fig. 2 Fig. 3



L-71 L-72 L-73

Für / For
 Per / Para / Pour
 MA-9



MA-9R
 48 mm

MA-9
 Handle
 140 mm
 Rostfrei
 Stainless Steel
 Inox

MC-70
 (MA-9 + L-71, L-72, L73)
 Komplet mit 1 Griff + 3 Spatel
 Complete with 1 Handle + 3 Spatulas
 Completo di 1 Manico + 3 Spatole
 Completo con 1 mango + 3 Espátulas
 Complete avec 1 Manche + 3 Spatules

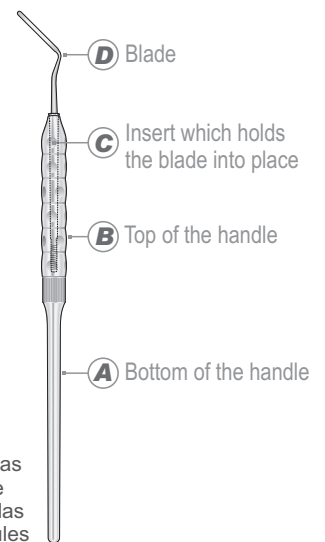

SDM-C

Komplett mit 2 Griffe + 20 Klängen
 Complete with 2 Handles + 20 Blades
 Completo di 2 Manici + 20 lame
 Completo con 2 mangos + 20 hojas
 Complete avec 2 Manches + 20 lames

SD-M

Griff
 Handle
 Manico
 Mango
 Manche

SDM-9

Komplett mit 2 Griffe + 9 Klängen APICALI
 Complete with 2 Handles + 9 Blades APICALI
 Completo di 2 Manici + 9 lame APICALI
 Completo con 2 mangos + 9 hojas APICALI
 Complete avec 2 Manches + 9 lames APICALI

SDM-11

Komplett mit 2 Griffe + 11 Klängen CERVICALI
 Complete with 2 Handles + 11 Blades CERVICALI
 Completo di 2 Manici + 11 lame CERVICALI
 Completo con 2 mangos + 11 hojas CERVICALI
 Complete avec 2 Manches + 11 lames CERVICALI

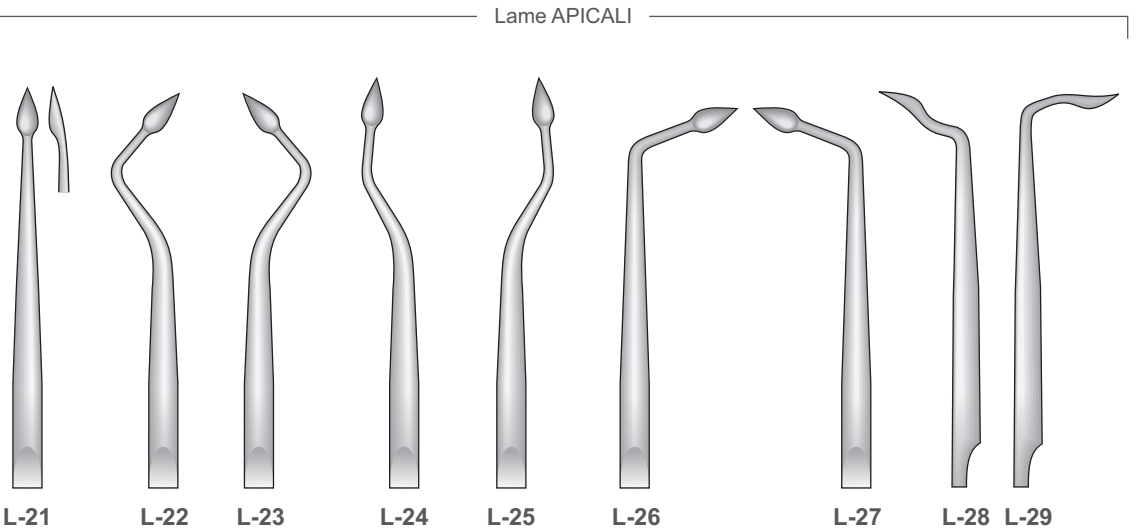
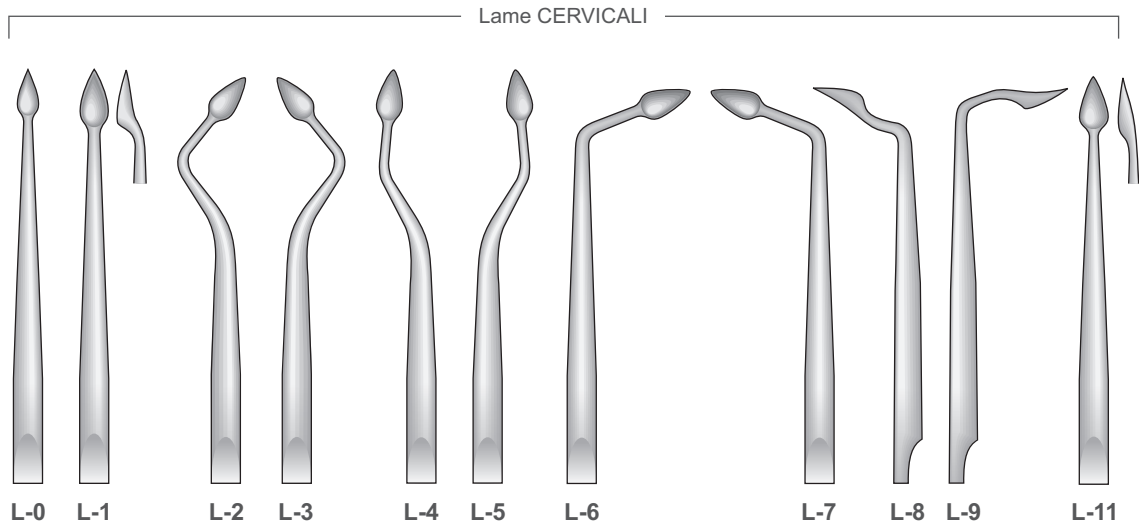

SD-M

▪ Scalpels

75 | Scalpel Handles and Blades



Skalpellgriffe - Mikro Skalpellklingen
 Scalpel Handles - Micro Scalpel Blades
 Manici per bisturi - Micro lame per bisturi
 Mangos de bisturí - Micro hojas de bisturí
 Manches pour bistouris - Micro lames de bistouri

Scalpel Handles and Blades

SCALPELS



LB-40
 Packung 10 Klingen
 Package 10 blades
 Scatola da 10 lame
 Cajita de 10 hojas
 Boite de 10 lames

Skalpellgriffe für Mikro-Klingen
 Scalpel handles for Micro blades
 Manici per micro lame
 Mangos de bisturí para micro hojas
 Manches de bistouris pour micro lames

Micro-Klingen
 Micro blades
 Micro lame
 Micro hojas
 Micro lames

Rasierklingen-Brecker und halter
 Razor blade breaker and holder
 Manico porta lame
 Mango para Hojas de afeitár
 Porte lames à rasoir

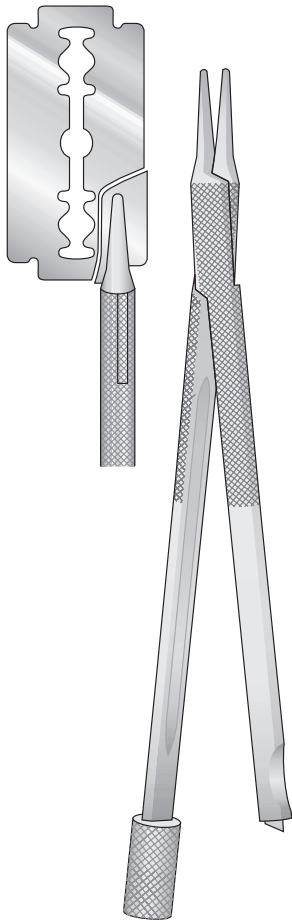

NK-12
 120 mm

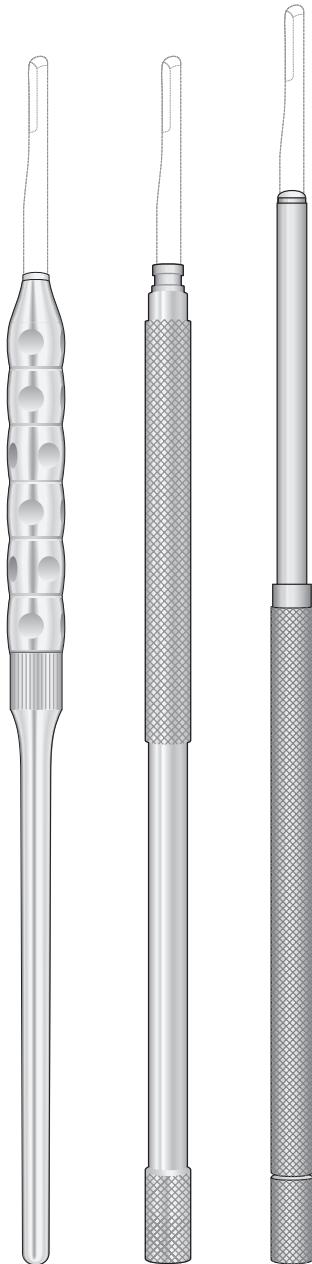

MA-11
 135 mm

BB-46
 135 mm

BB-48
 155 mm



LB-361
 Conf. 10 pz.



LB-362
 Conf. 10 pz.



LB-363
 Conf. 1 pz.



LB-364
 Conf. 10 pz.



LB-365
 Conf. 10 pz.

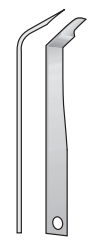

LB-366
 Conf. 1 pz.



LB-367
 Conf. 10 pz.



LB-368
 Conf. 10 pz.



LB-369
 Conf. 1 pz.

Skalpellgriffe
Scalpel Handles
Manici porta lame
Mangos de bisturí
Manches de bistouri

SCALPELS

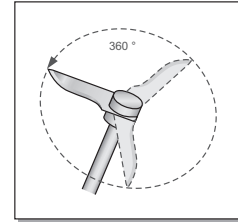

Für Mikro-Klingen
For Micro Blades
Per micro lame
Para micro Hojas
Pour Micro-Lame de bistouris



NK-1
100 mm



NK-3
130 mm



NK-2
150 mm

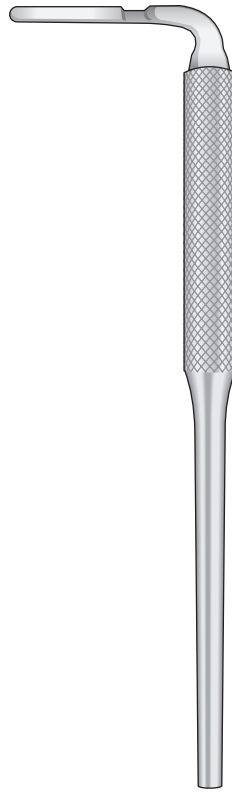

MA-B16
120 mm

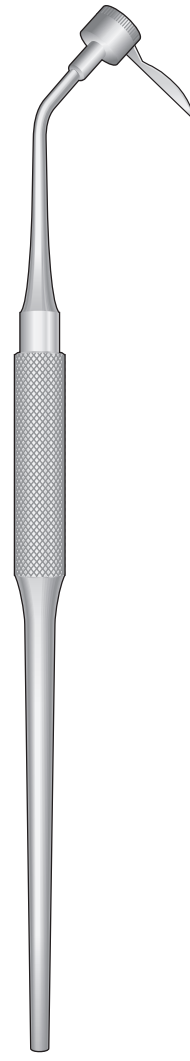

GB-4
165 mm

Skalpelle und Skalpellgriffe
 Scalpel Blades and Handle
 Lame e manici per bisturi
 Hojas y mangos de bisturí
 Lames et manches de bistouri

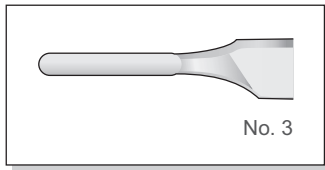

Packungen à 100
 Packages of 100 ea
 Scatole da 100 pezzi
 Cajas de 100 c/u
 Boîtes de 100 pièces



LB-10
Fig. 10



LB-11
Fig. 11

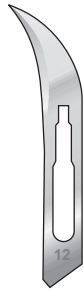

LB-12
Fig. 12

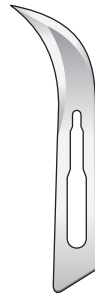

LB-12D
Fig. 12D



LB-13
Fig. 13



LB-15
Fig. 15



LB-15A
Fig. 15A



LB-15C
Fig. 15C

SCALPELS



MA-B3



MA-B3M
Fig. 3M



MA-B7



MA-B7K



MA-B1
Fig. 5



MA-B2
Fig. 5A



MA-B8/MA-B9
155 mm

Doppelt Skalpellgriff
 Scalpel Handle double Blade
 Manico per bisturi a doppia lama
 Mango de bisturí doble hojas
 Manche pour bistouri double-lames

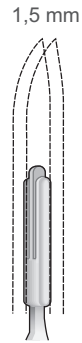

MA-B8

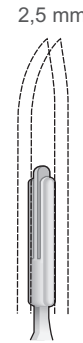

MA-B9

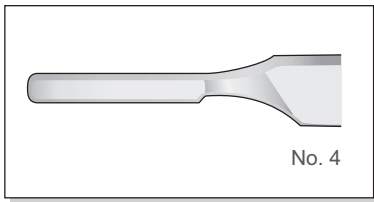

Packungen à 100
Packages of 100 ea
Scatole da 100 pezzi
Cajas de 100 c/u
Boîtes de 100 pièces



LB-18
Fig. 18



LB-20
Fig. 20



LB-21
Fig. 21



LB-23
Fig. 23

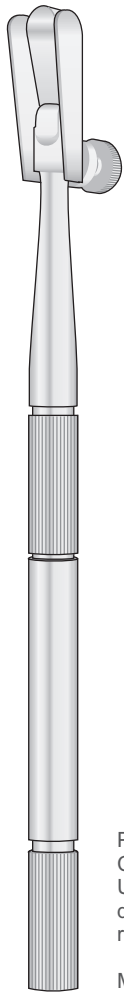

PAQUETTE
BLADE HOLDER
GB-2
160 mm

Palatal, Gingival,
Connective Tissue Grafts
Uses standard
double-edged
razor blade

Mucotomo



MA-B4
Fig. 4

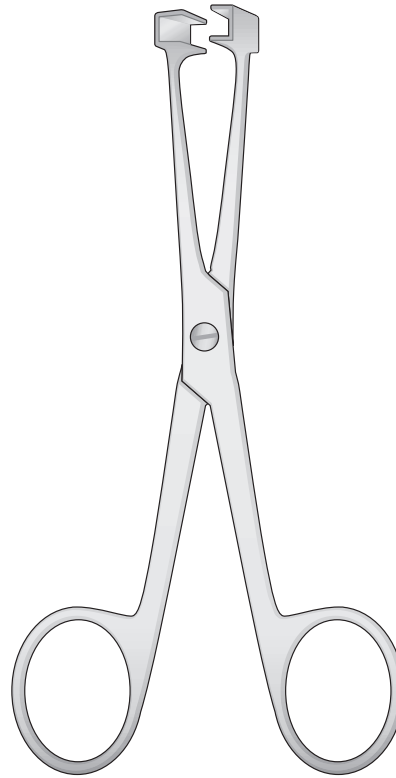

GS-18
135 mm

Klingentfemer
Scalpel blade removing
forceps
Pinze togilama
Pinza para quitar hojas de bisturías
Pince pour enlever les lames de bistouris

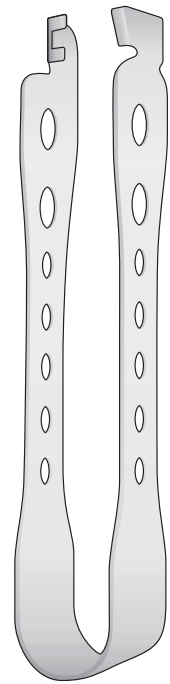

GS-16
115 mm

Messer
Knives
Coltelli
Cuchillos
Couteaux

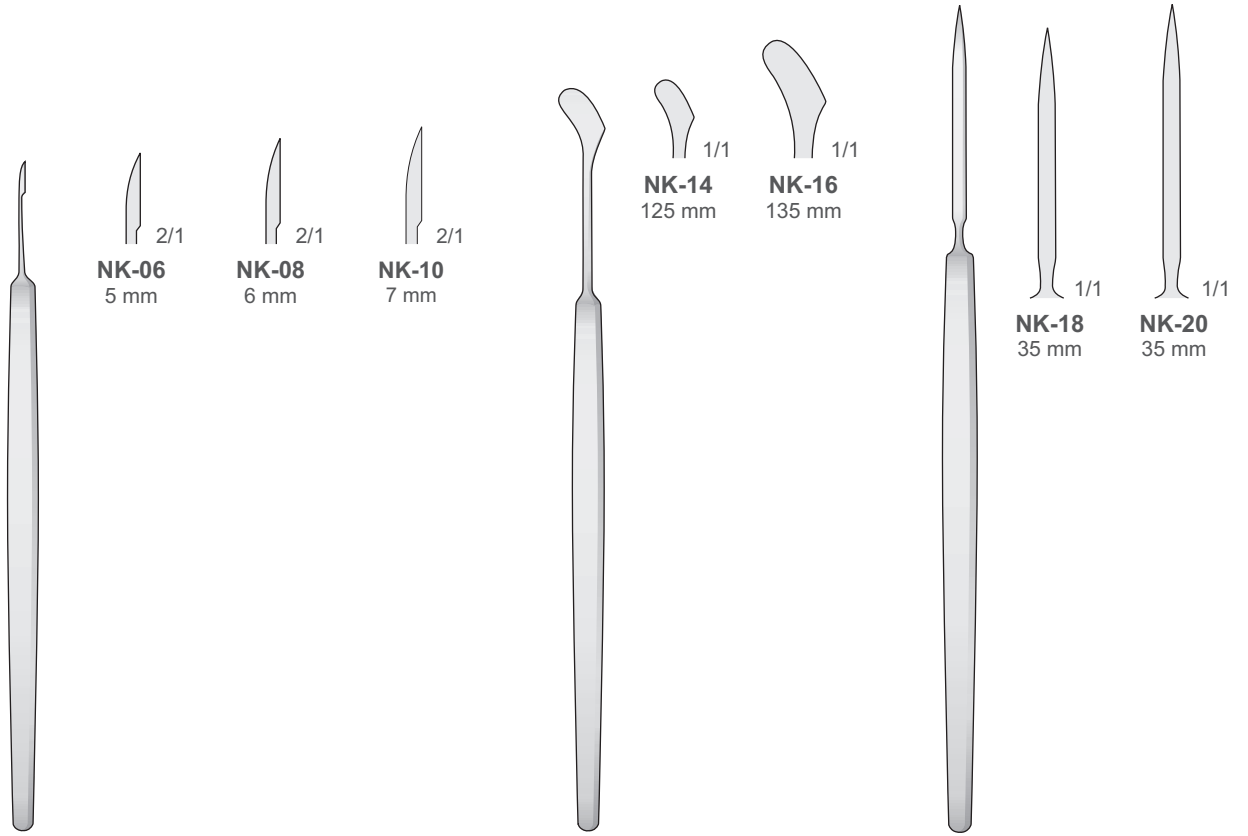

ZIEGLER
NK-06/NK-10
115 mm

GRAEFE
NK-14/NK-16

GRAEFE
NK-18/NK-20
140 mm

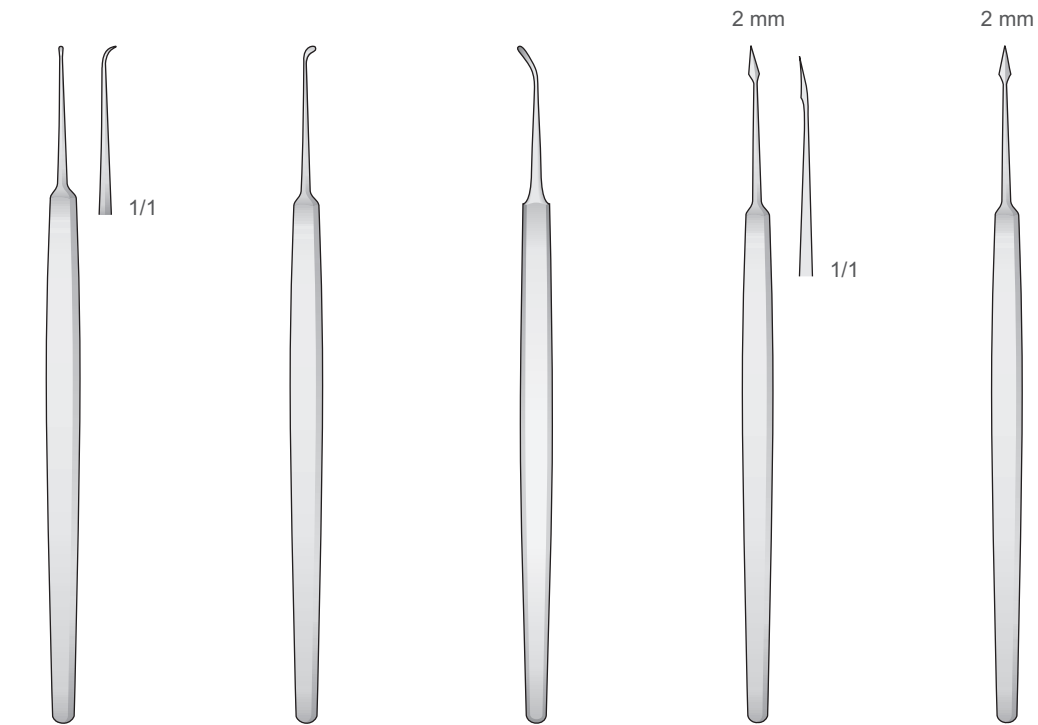

LA FORCE
NK-07
120 mm

ELLIS
NK-09
120 mm

NK-11
125 mm

NK-17
125 mm

NK-39
125 mm

SCALPELS

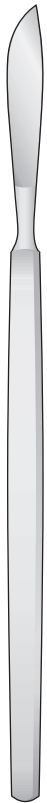

NK-30/NK-40



NK-30
120 mm

1/1



NK-32
125 mm

1/1



NK-34
130 mm

1/1



NK-36
120 mm

1/1



NK-38
125 mm

1/1



NK-40
130 mm

1/1

• Scissors

83 | Micro Scissors

84 | Surgical Scissors

108 | Ligature Scissors

109 | Wire and Plate



SCISSORS

Mikro-Scheren
 Micro Scissors
 Micro Forbici
 Micro Tijeras
 Micro Ciseaux

Micro Scissors

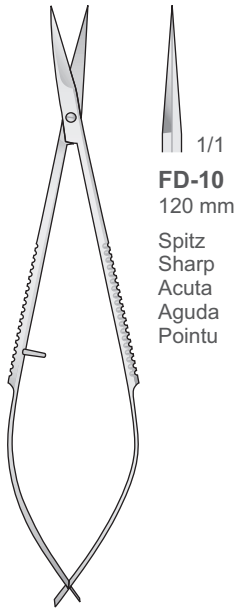

1/1
FD-10
 120 mm
 Spitz
 Sharp
 Acuta
 Aguda
 Pointu

NOYES
FD-10
 120 mm

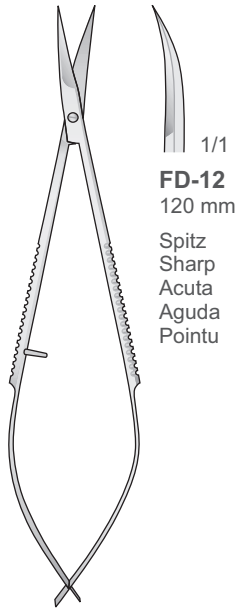

1/1
FD-12
 120 mm
 Spitz
 Sharp
 Acuta
 Aguda
 Pointu

NOYES
FD-12
 120 mm

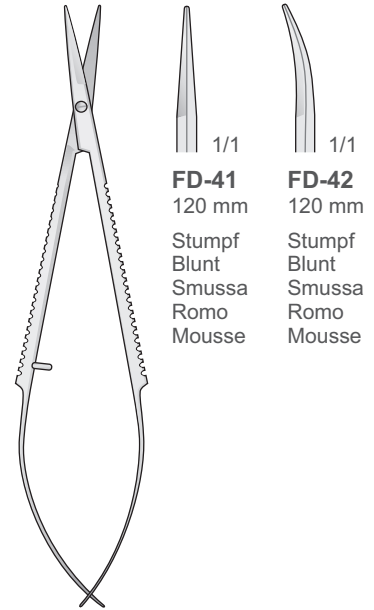

1/1 1/1
FD-41 **FD-42**
 120 mm 120 mm
 Stumpf
 Blunt
 Smussa
 Romo
 Mousse

FD-41/FD-42
 120 mm

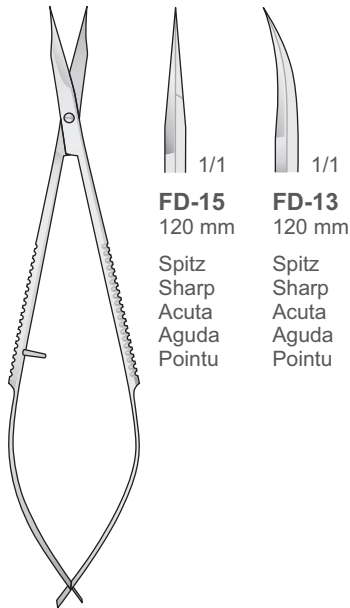

1/1 1/1
FD-15 **FD-13**
 120 mm 120 mm
 Spitz
 Sharp
 Acuta
 Aguda
 Pointu

WESTCOTT
FD-13/FD-15
 120 mm

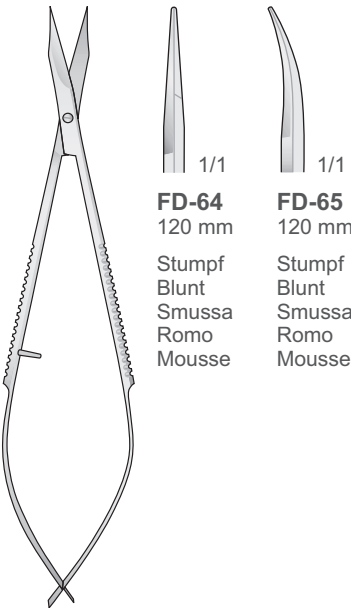

1/1 1/1
FD-64 **FD-65**
 120 mm 120 mm
 Stumpf
 Blunt
 Smussa
 Romo
 Mousse

WESTCOTT
FD-64/FD-65
 120 mm

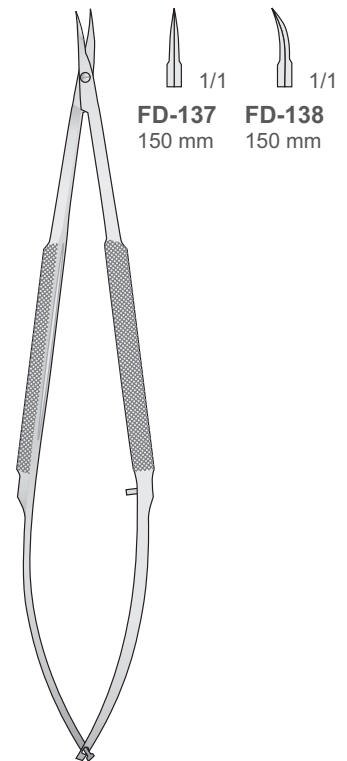

1/1 1/1
FD-137 **FD-138**
 150 mm 150 mm

FD-137/FD-138
 150 mm

SCISSORS

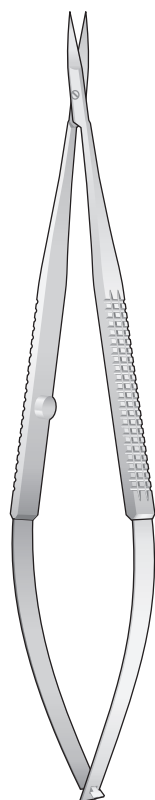

FD-182
160 mm
Spitz
Sharp
Acuta
Aguda
Pointu

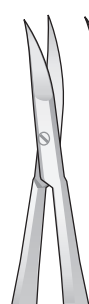
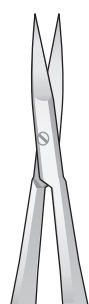

FD-183
160 mm
Spitz
Sharp
Acuta
Aguda
Pointu

1/1

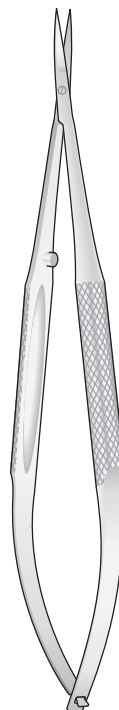

FD-224
145 mm
Spitz
Sharp
Acuta
Aguda
Pointu



1/1



1/1

FD-225
145 mm
Spitz
Sharp
Acuta
Aguda
Pointu

FD-182/FD-183
160 mm

FD-224/FD-225
145 mm

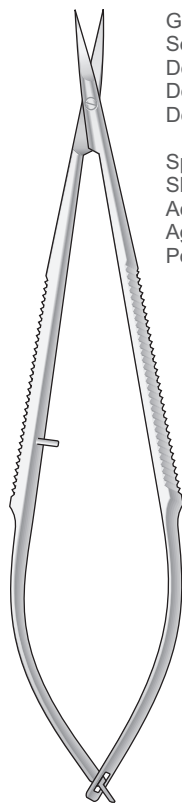

Gezahnt
Serrated
Dentellata
Dentada
Dentelé

Spitz
Sharp
Acuta
Aguda
Pointu

FD-145
160 mm

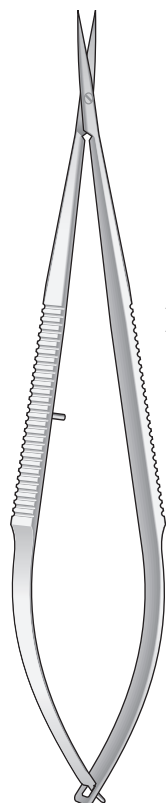

FD-06
160 mm
Spitz
Sharp
Acuta
Aguda
Pointu



1/1

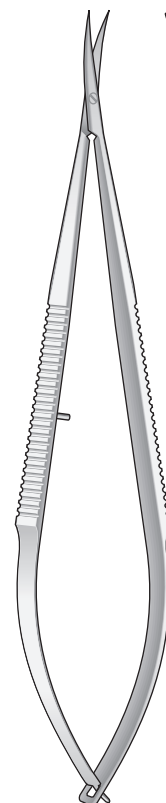

FD-08
160 mm
Spitz
Sharp
Acuta
Aguda
Pointu



1/1

FD-06
160 mm

FD-08
160 mm

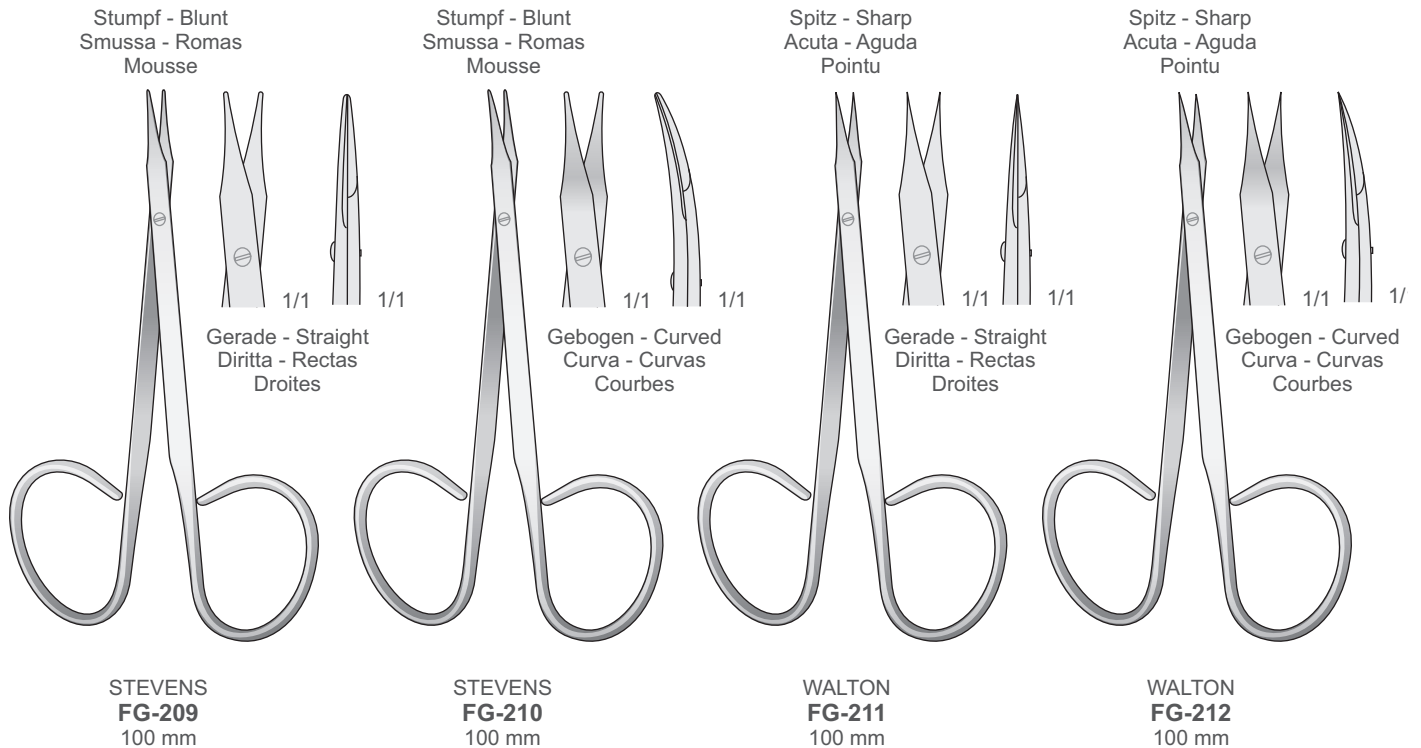
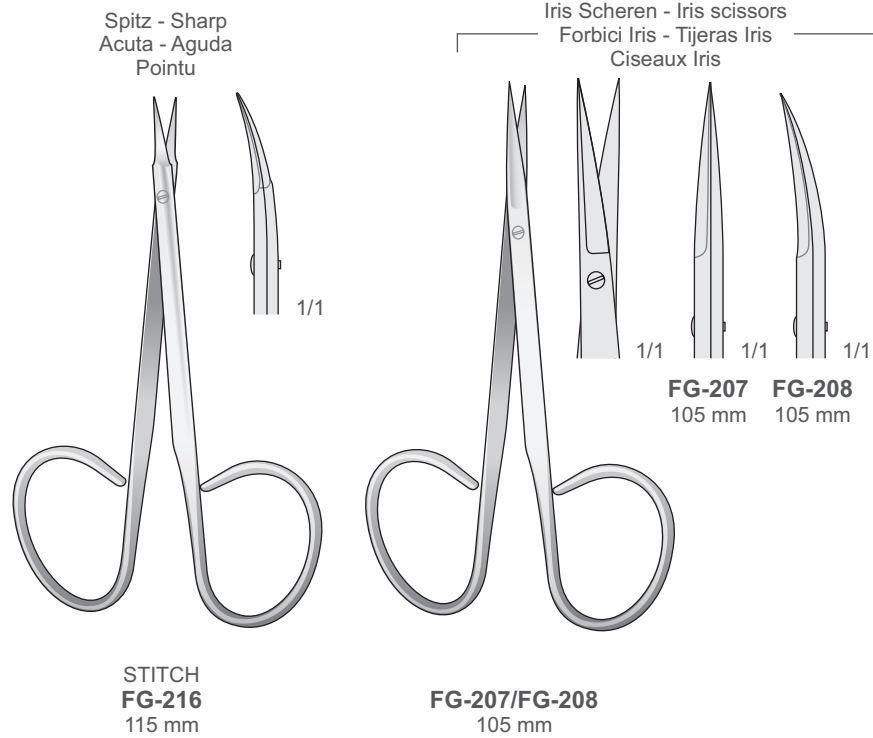

L = links
left
mancini
izquierdo
gauche

SCISSORS

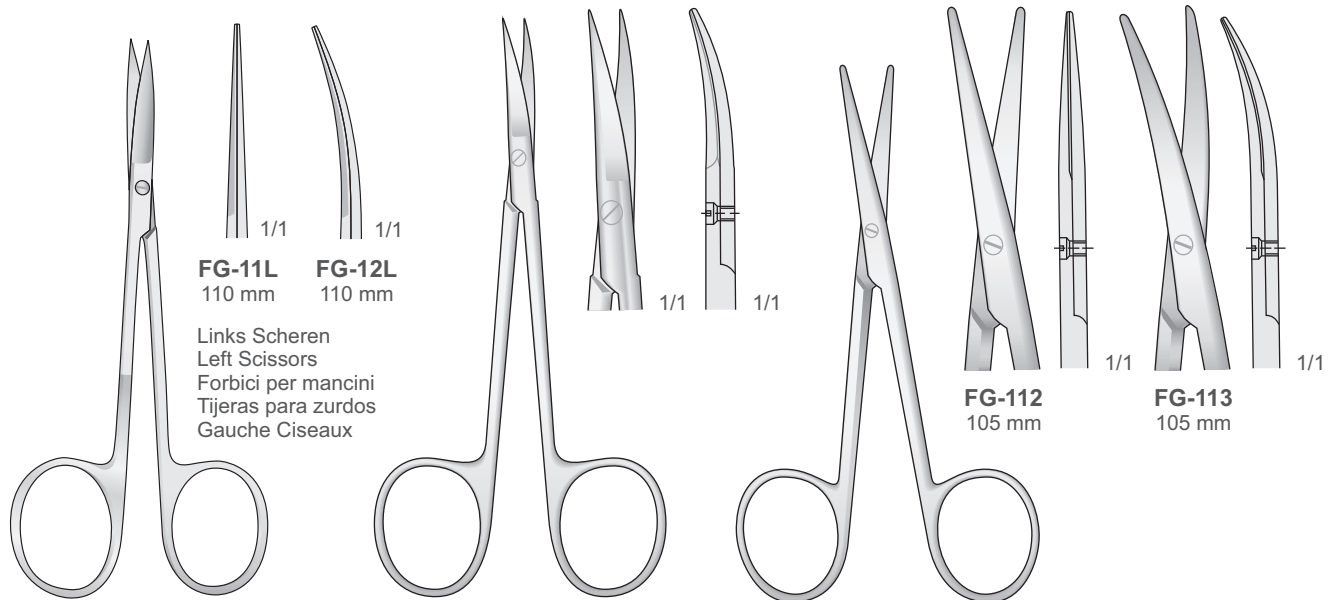

IRIS
FG-11L/FG-12L
110 mm

FG-11L 110 mm
FG-12L 110 mm

Links Scheren
Left Scissors
Forbici per mancini
Tijeras para zurdos
Gauche Ciseaux

COTTLE
FG-59
115 mm

COTTLE-KNAPP
FG-112/FG-113
105 mm

FG-112 105 mm

FG-113 105 mm

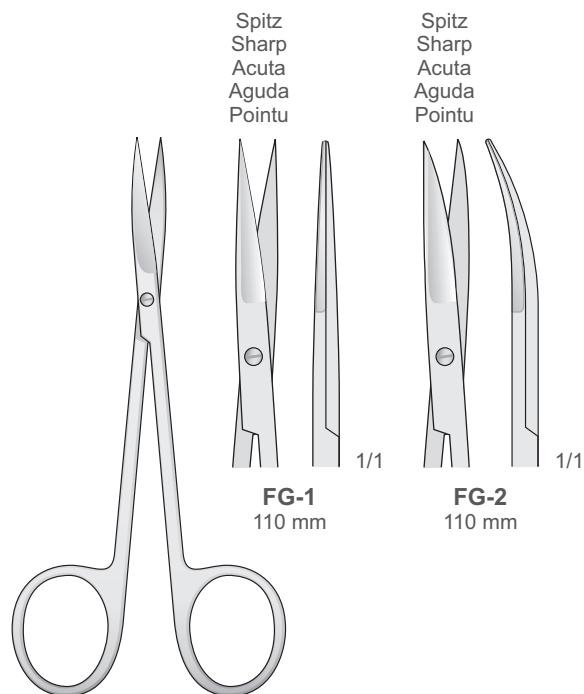

IRIS
FG-1/FG-2
110 mm

FG-1 110 mm

FG-2 110 mm

Spitz
Sharp
Acuta
Aguda
Pointu

Spitz
Sharp
Acuta
Aguda
Pointu

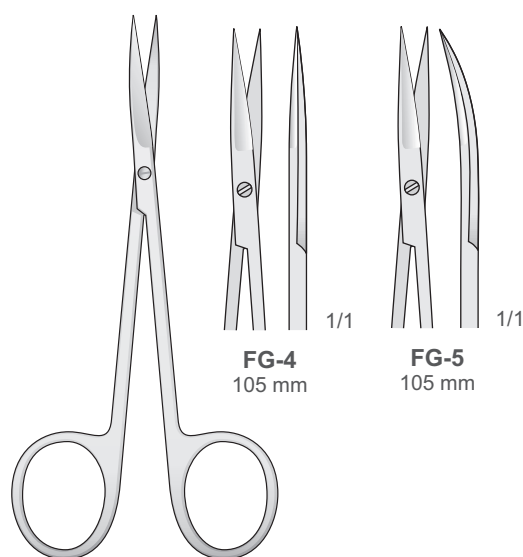

FG-4/FG-5
105 mm

FG-4 105 mm

FG-5 105 mm

Spitz
Sharp
Acuta
Aguda
Pointu

Spitz
Sharp
Acuta
Aguda
Pointu

Gezahnt - Serrated
Dentellata - Dentelé - Dentadas



FG-156/FG-157
110 mm

Gezahnt - Serrated
Dentellata - Dentelé - Dentadas

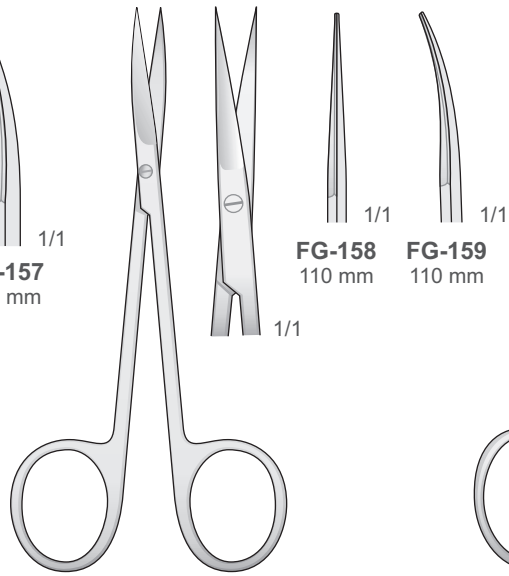

FG-158/FG-159
110 mm

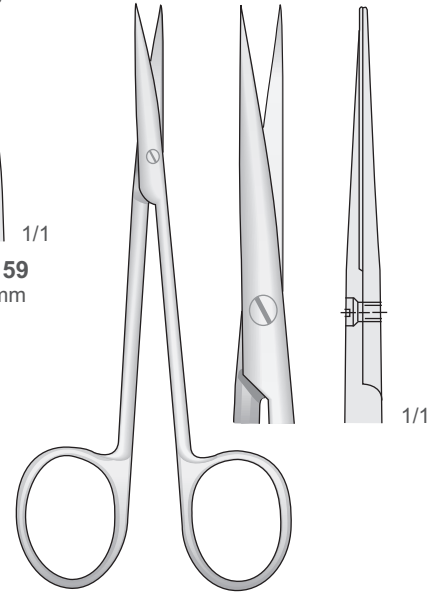

**KILNER
FG-58**
115 mm

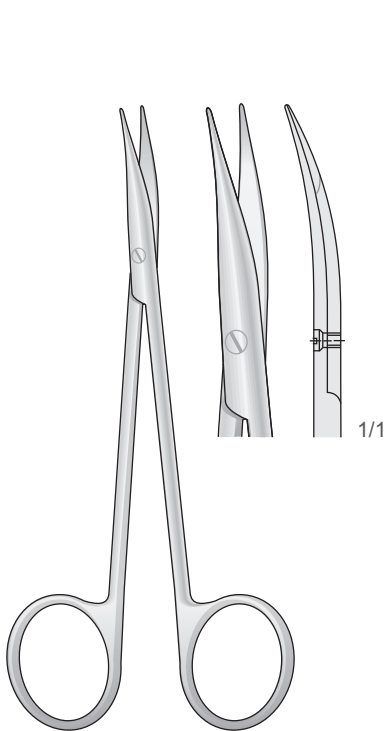

**JAMESON-WERBER
FG-123**
130 mm

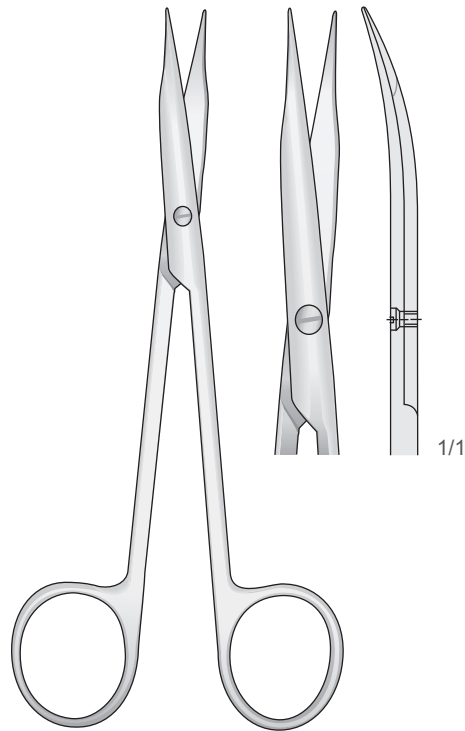

**JAMESON
FG-124**
145 mm

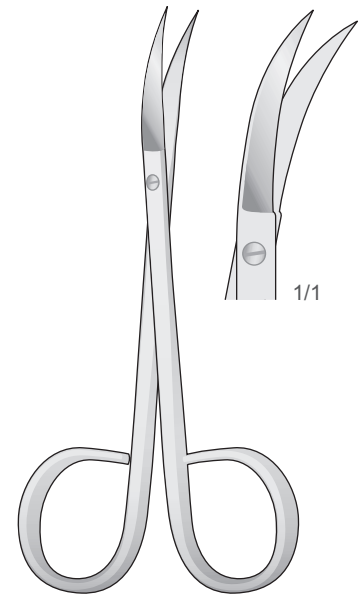

FG-3
115 mm

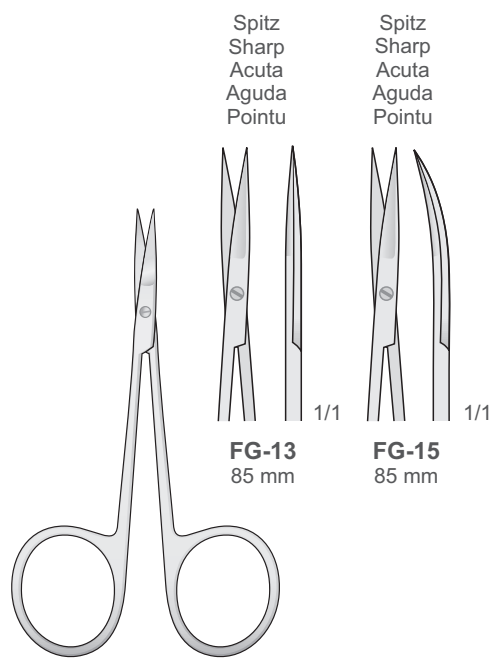

Spitz
Sharp
Acuta
Aguda
Pointu

Spitz
Sharp
Acuta
Aguda
Pointu

FG-13
85 mm

FG-15
85 mm

MICRO-IRIS
FG-13/FG-15
85 mm

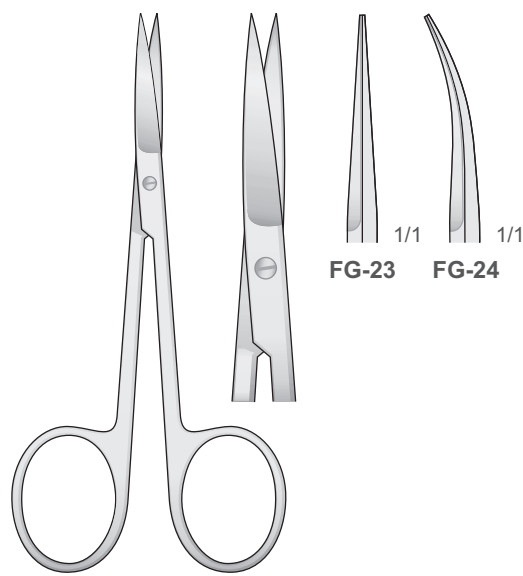

FG-23

FG-24

FG-23/FG-24
110 mm

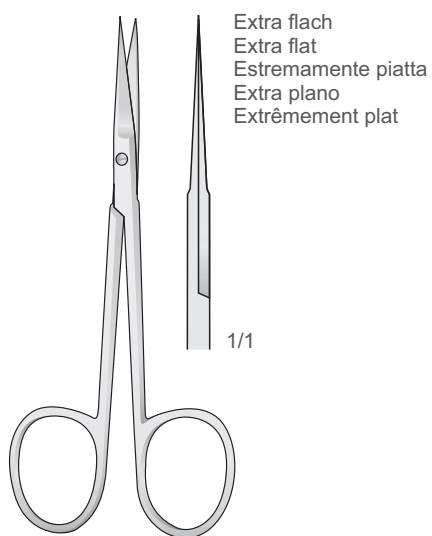

Extra flach
Extra flat
Estremamente piatta
Extra plano
Extrêmement plat

FG-104
100 mm

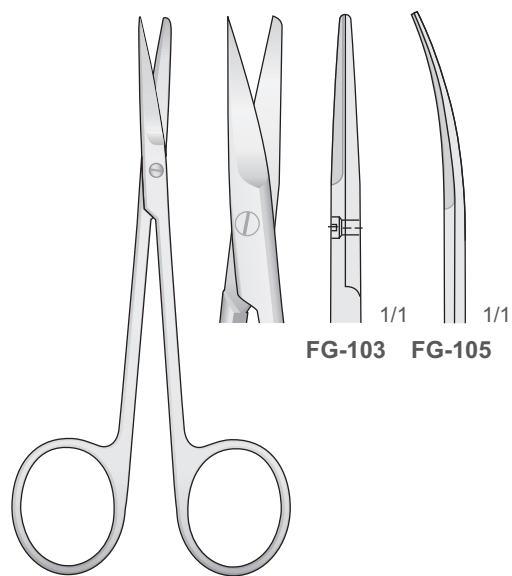

FG-103

FG-105

FG-103/FG-105
110 mm

Scheren
Scissors
Forbici
Tijeras
Ciseaux

Spitz - Sharp
Acuta - Agudo
Aigu

Spitz - Sharp
Acuta - Agudo
Aigu



FM-126

FM-127

**METZENBAUM
FM-126/FM-127**
145 mm

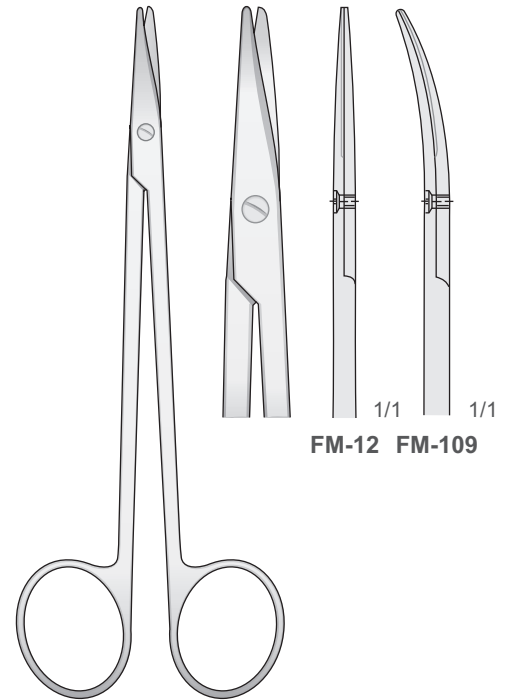

FM-12 FM-109

**METZENBAUM
FM-12/FM-109**
150 mm

SCISSORS

1/1
Spitz
Sharp
Acuta
Aguda
Pointu

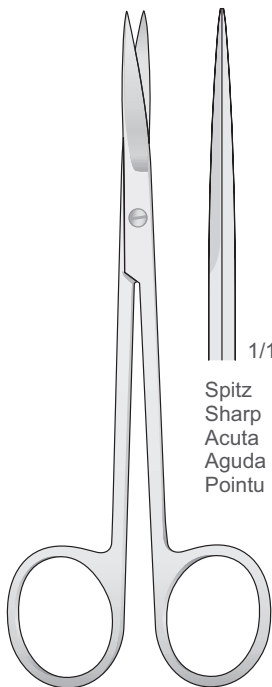

**METZENBAUM
FG-28**
145 mm

1/1
Spitz
Sharp
Acuta
Aguda
Pointu

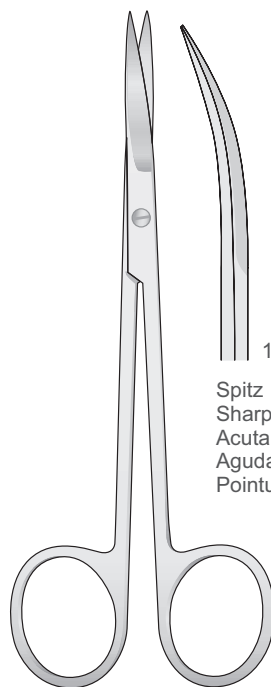

**METZENBAUM
FG-14**
145 mm

FG-147
150 mm

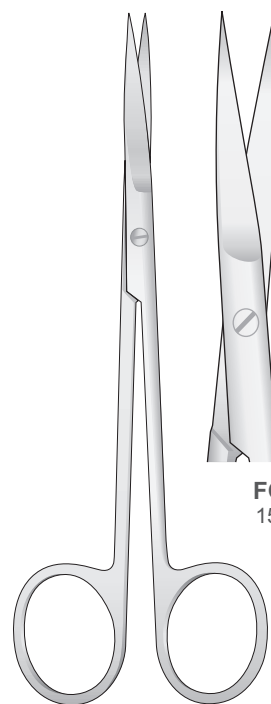

**JOSEPH
FG-147/FG-148**
150 mm

FG-148
150 mm

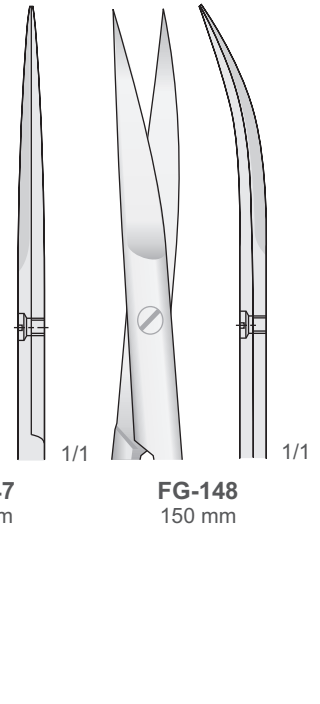

Stumpf
Blunt
Smussa
Romass
Mousse

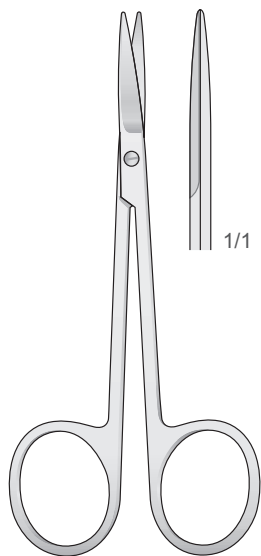

FG-101
110 mm

Stumpf
Blunt
Smussa
Romass
Mousse

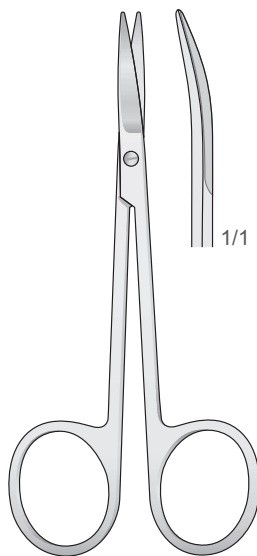

FG-102
110 mm

Stumpf
Blunt
Smussa
Romass
Mousse

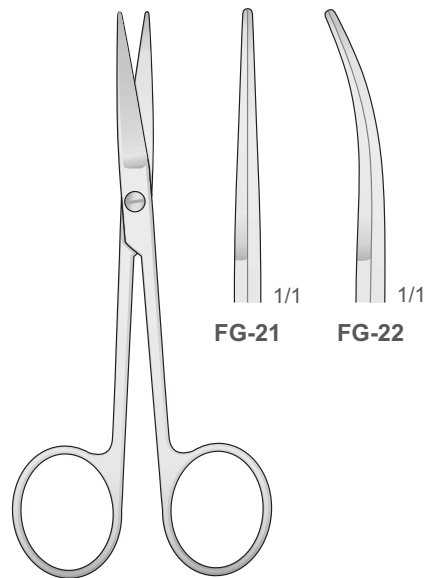

FG-21/FG-22
115 mm

Spitz
Sharp
Acute
Agudas
Pointu

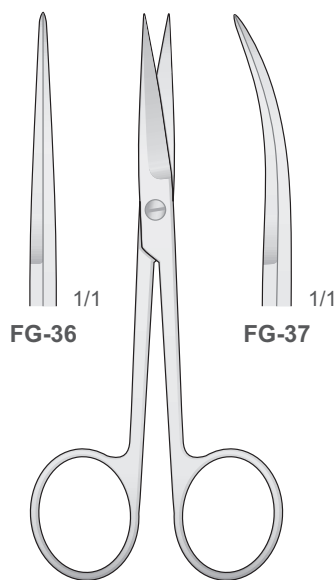

FG-36/FG-37
115 mm

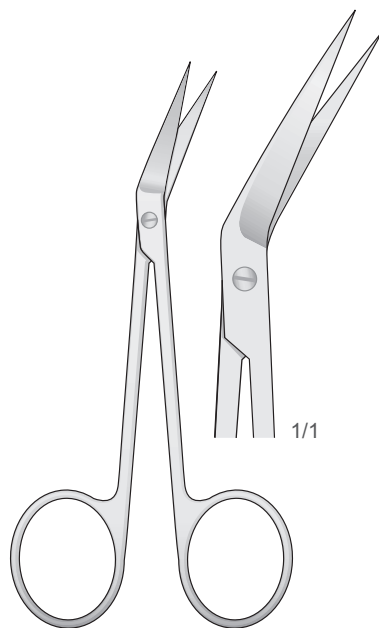

**LOCKLIN
LK-1**
115 mm

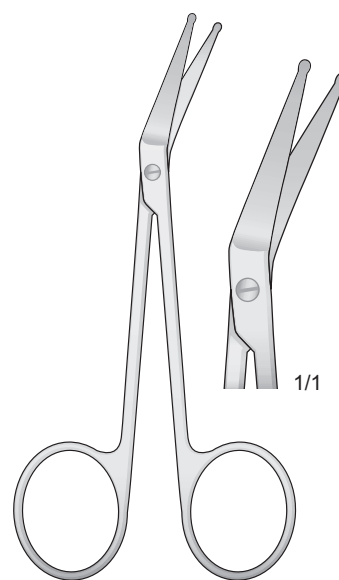

**LOCKLIN MOD.
LK-3**
110 mm

Scheren
Scissors
Forbici
Tijeras
Ciseaux

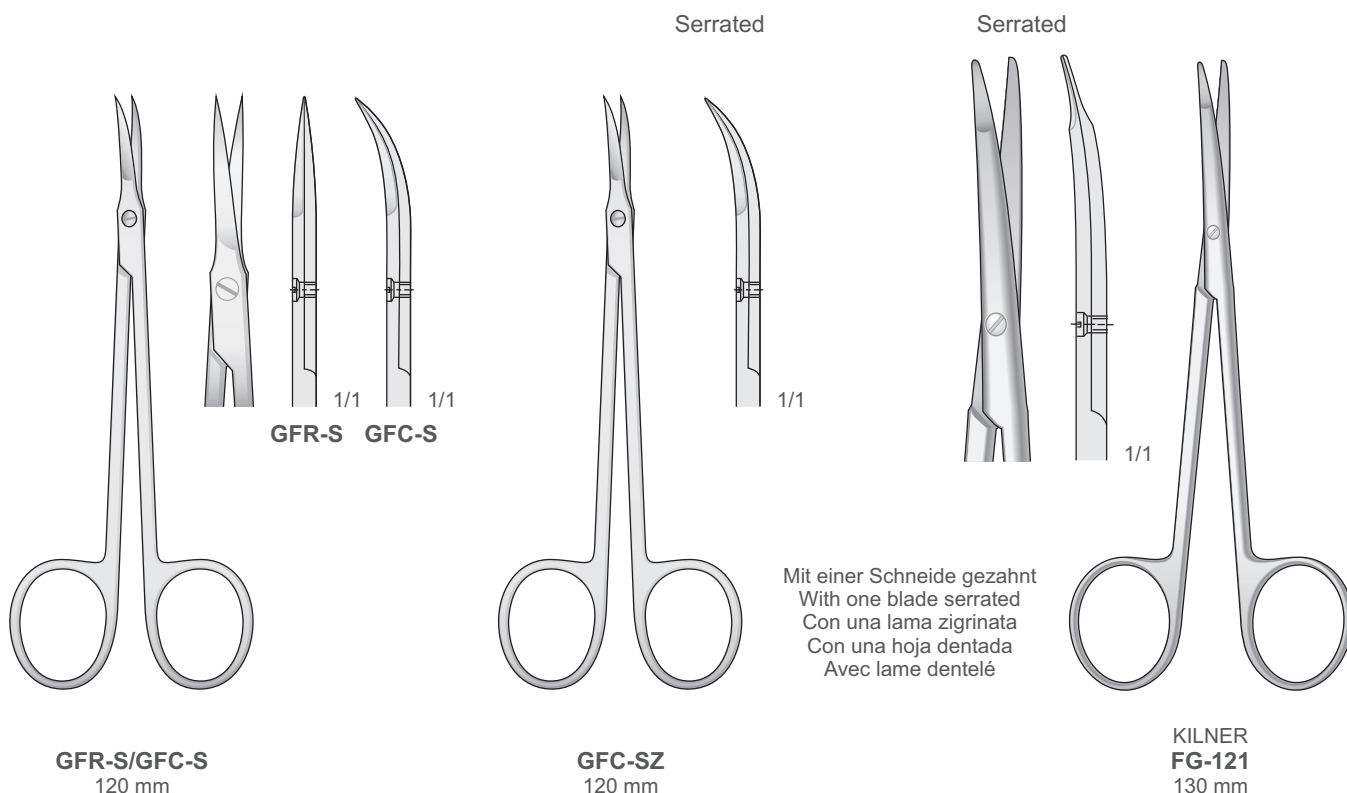

SCISSORS

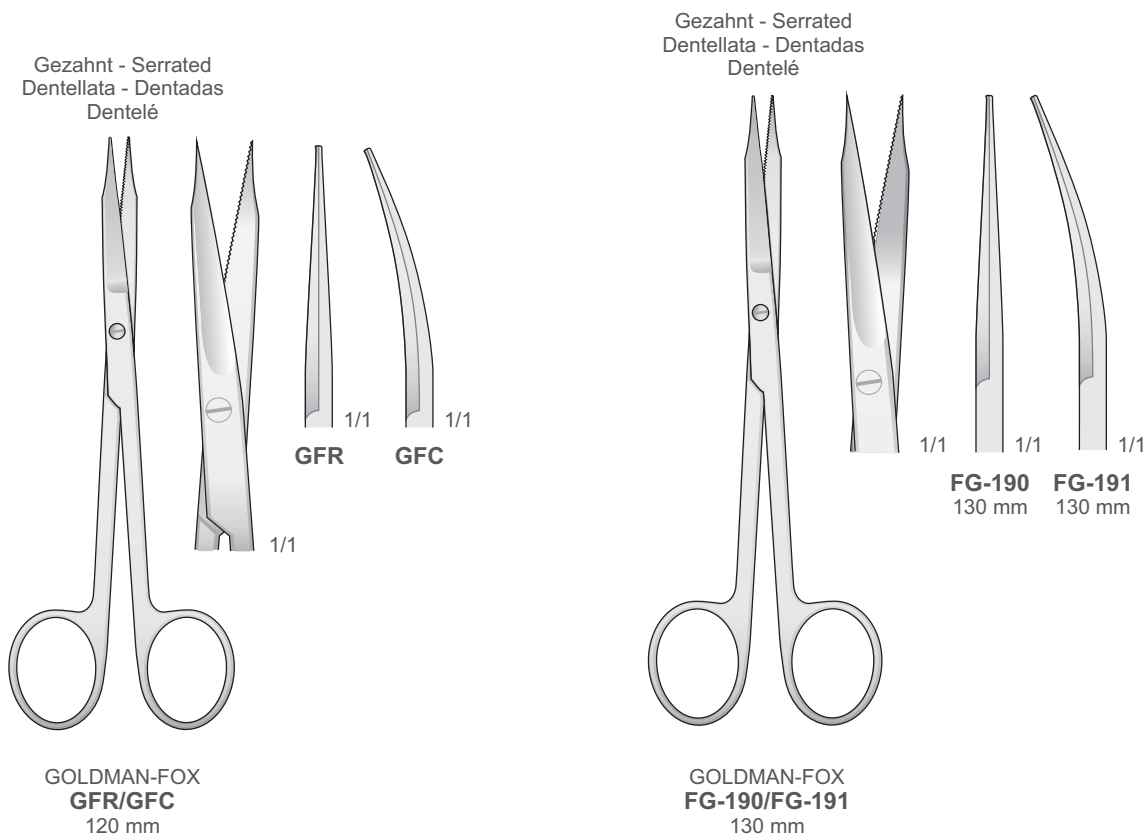

Gezahnt - Serrated
Dentellata - Dentadas
Dentelé



LOCKLIN
LK-2
160 mm

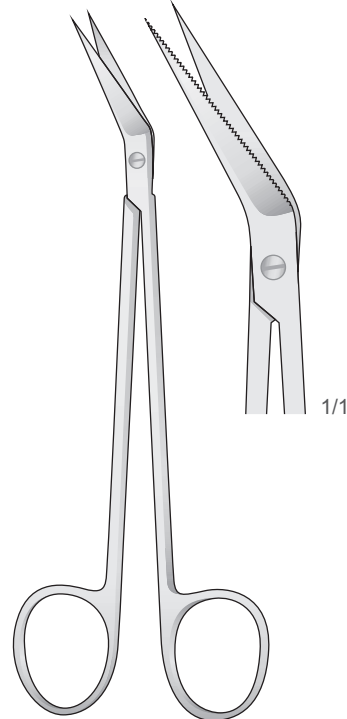

LOCKLIN
LK-4
160 mm

Gezahnt - Serrated
Dentellata - Dentadas
Dentelé

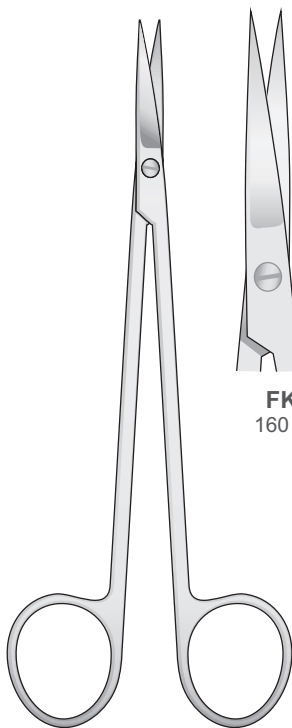

KELLY
FK-1/FK-2
160 mm

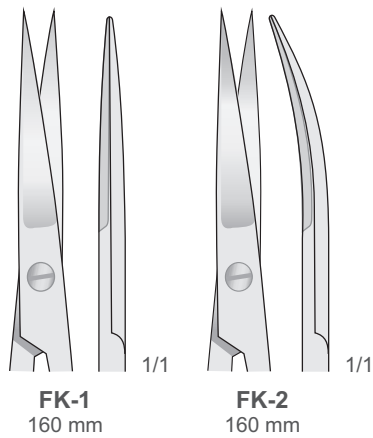

FK-1
160 mm

FK-2
160 mm

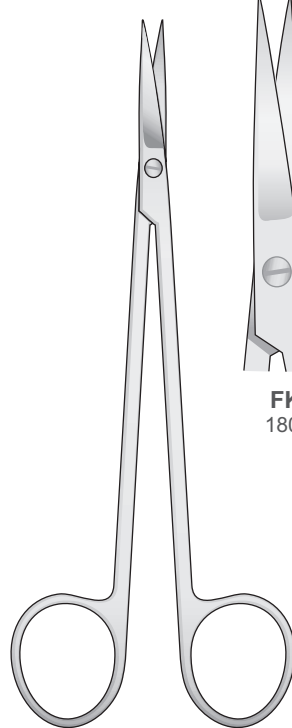

KELLY
FK-87/FK-88
180 mm

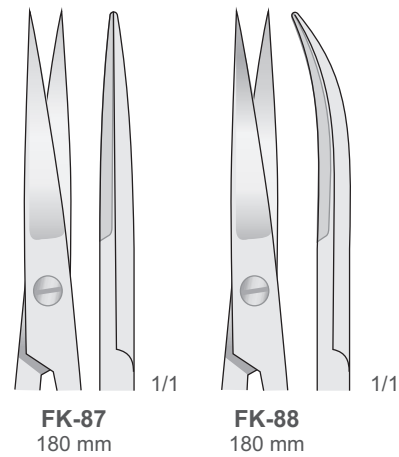

FK-87
180 mm

FK-88
180 mm

Scheren
Scissors
Forbici
Tijeras
Ciseaux

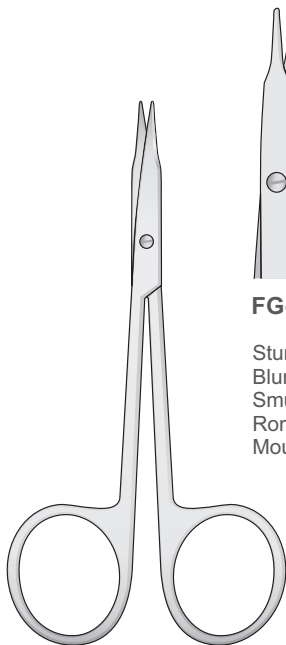

STEVENS
FG-50/FG-53
110 mm

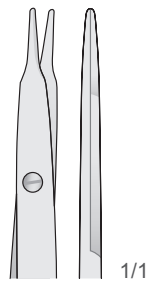

FG-50

Stumpf Gerade
Blunt Straight
Smussa Diritta
Romas Rectas
Mousse Droites

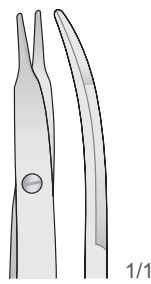

FG-51

Stumpf Gebogen
Blunt Curved
Smussa Curva
Romas Curvas
Mousse Courbes

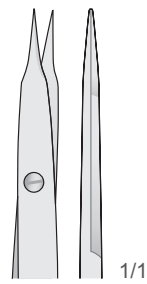

FG-52

Spitz Gerade
Sharp Straight
Acuta Diritta
Agudas Rectas
Pointu Droites

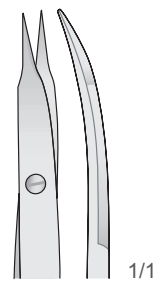

FG-53

Spitz Gebogen
Sharp Curved
Acuta Curva
Agudas Curvas
Pointu Courbes

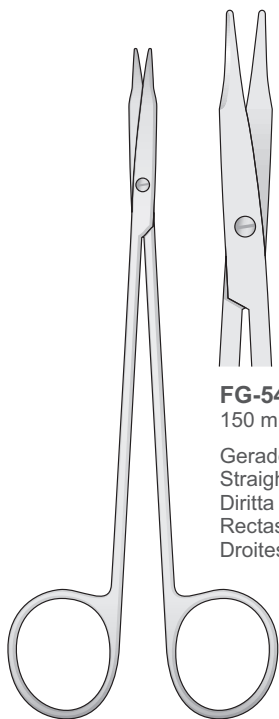

REYNOLDS
FG-54/FG-55

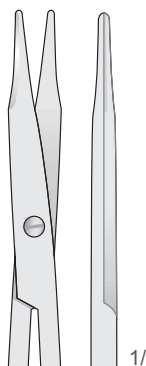

FG-54
150 mm

Gerade
Straight
Diritta
Rectas
Droites

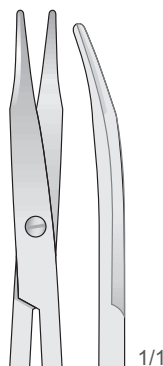

FG-55
150 mm

Gebogen
Curved
Curva
Curvas
Courbes

Stumpf
Blunt
Smussa
Romas
Mousse

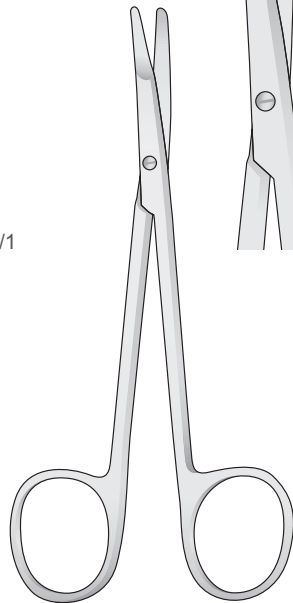

KILNER
FG-19C/FG-67

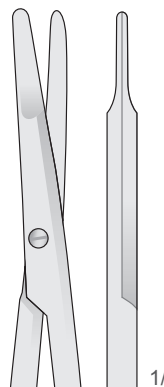

FG-66
120 mm

Gerade
Straight
Diritta
Rectas
Droites

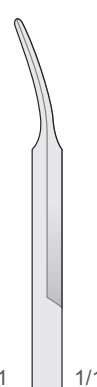

FG-67
120 mm

Gebogen
Curved
Curva
Curvas
Courbes

Stumpf
Blunt
Smussa
Romas
Mousse

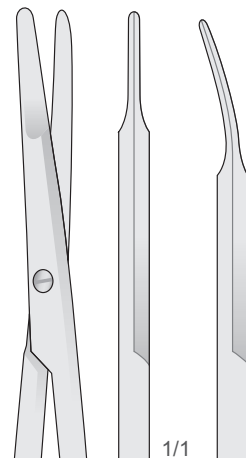

FG-19R
135 mm

Gerade
Straight
Diritta
Rectas
Droites

FG-19C
135 mm

Gebogen
Curved
Curva
Curvas
Courbes

Gezahnt - Serrated
 Dentellata - Dentadas
 Dentelé

Scheren
 Scissors
 Forbici
 Tijeras
 Ciseaux

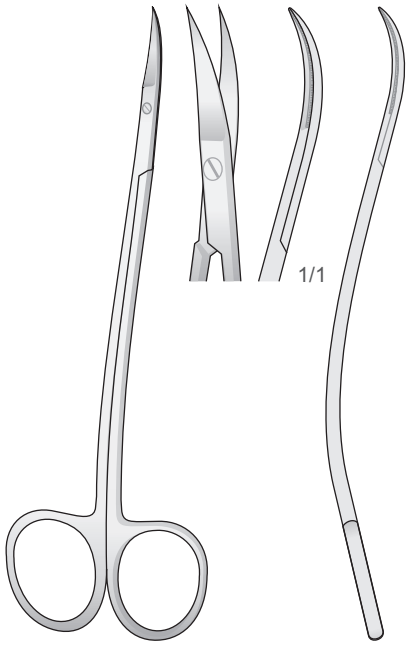

LA GRANGE
LG-1
 115 mm

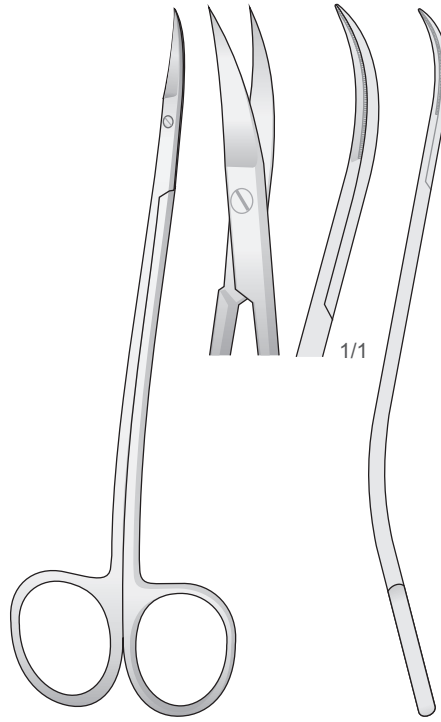

LA GRANGE
LG-6
 155 mm

Gezahnt - Serrated
 Dentellata - Dentada
 Dentée

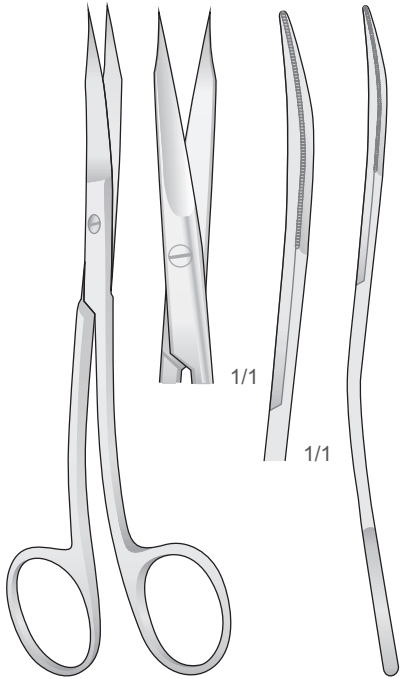

GOLDMAN-FOX S FORM
GFS
 130 mm

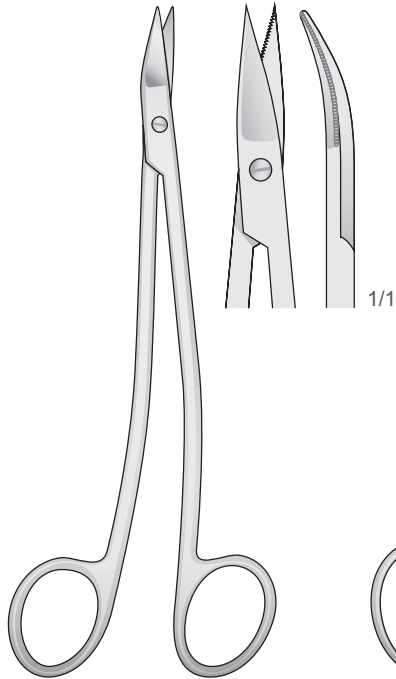

NEUMANN
FG-20
 130 mm

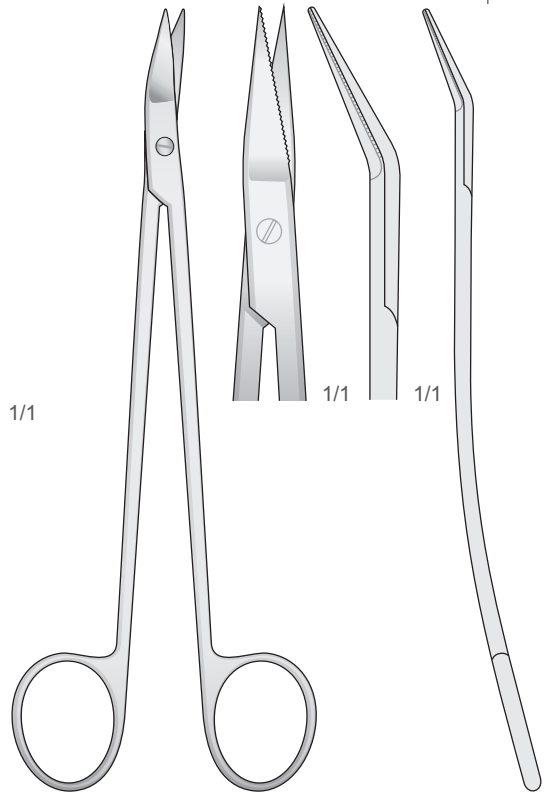

DEAN
DEAN
 180 mm

Scheren
 Scissors
 Forbici
 Tijeras
 Ciseaux

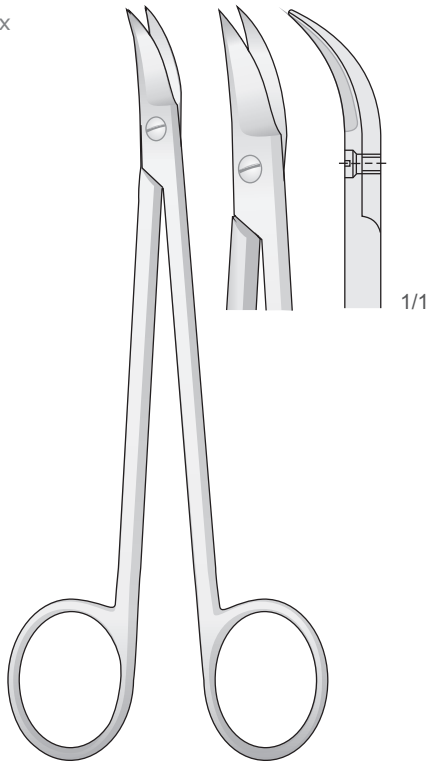

QUINBY
FG-38
 130 mm

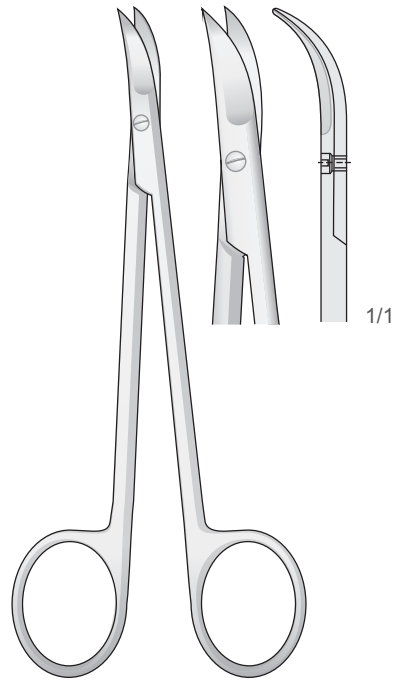

CHADWICK
FG-39
 115 mm

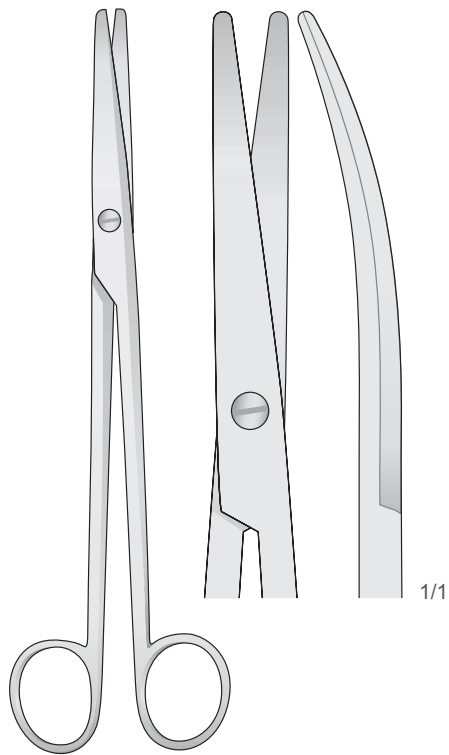

MAYO-LEXER
FM-79
 165 mm

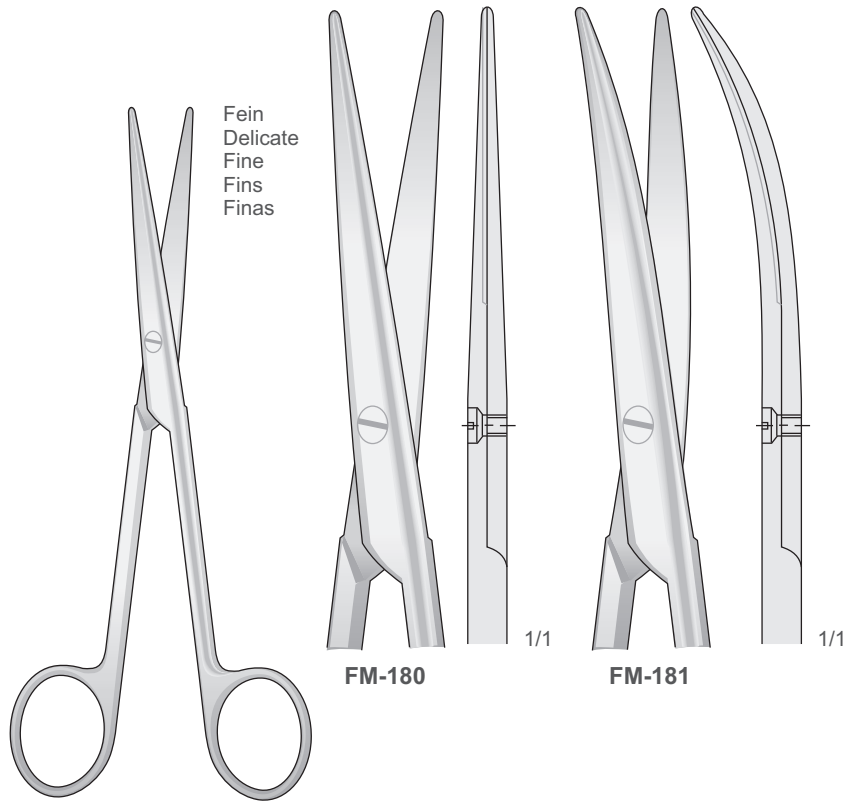

LEXER
FM-180/FM-181
 165 mm

Stumpf
Blunt
Smusse
Romas
Mousses

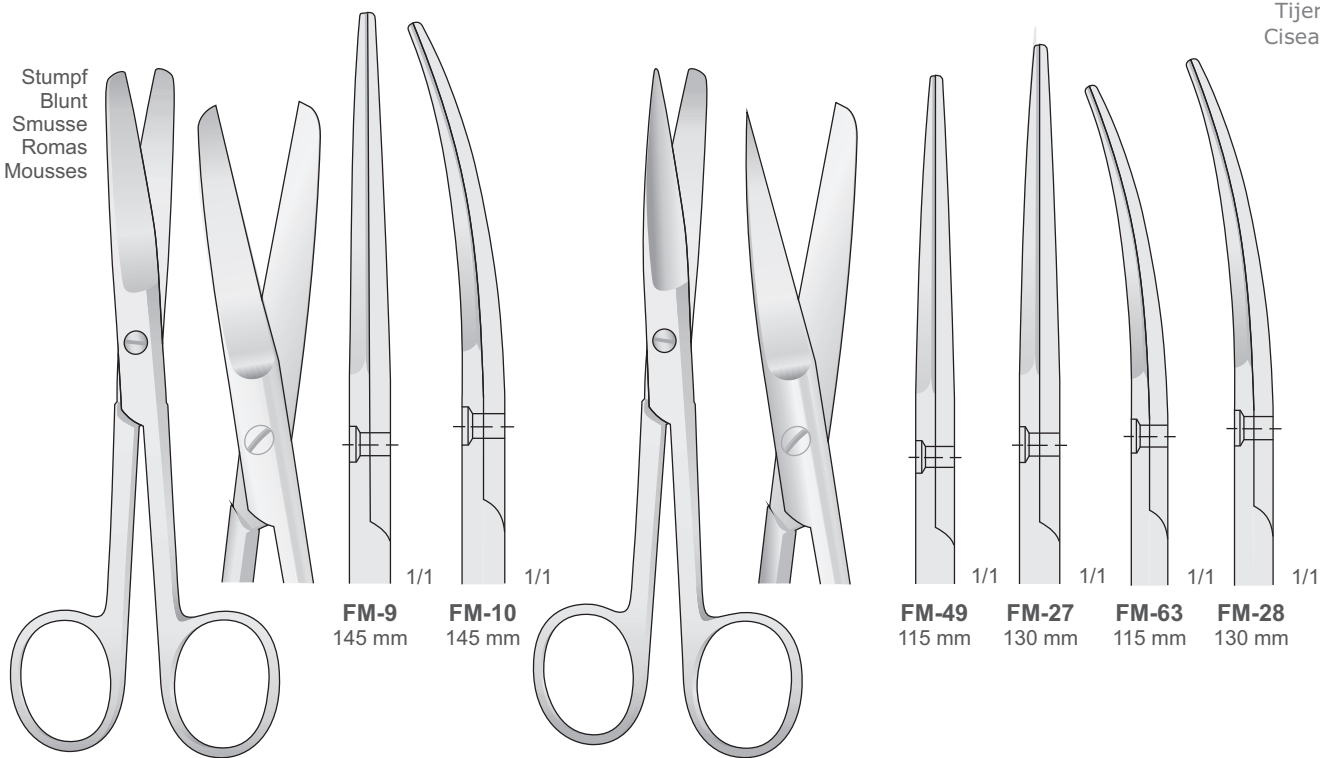

FM-9
145 mm

FM-10
145 mm

FM-49
115 mm

FM-27
130 mm

FM-63
115 mm

FM-28
130 mm

FM-9/FM-10
145 mm

FM-27/FM-63

Stumpf
Blunt
Smusse
Romas
Mousses

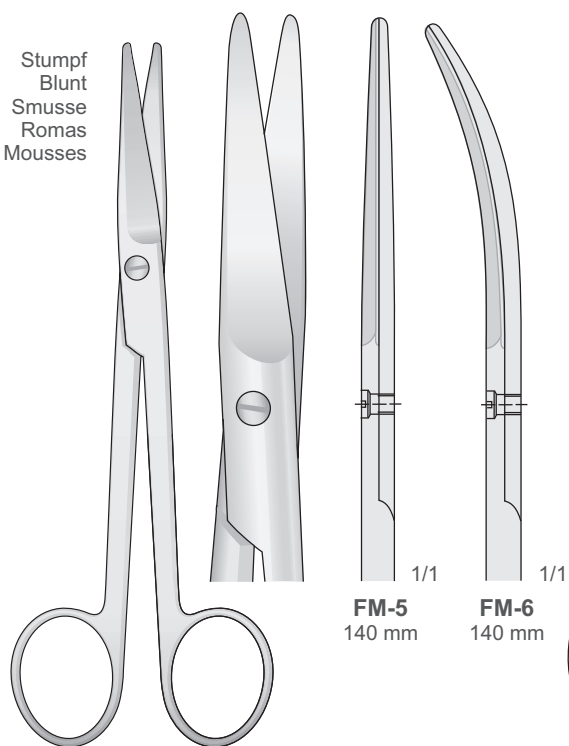

FM-5
140 mm

FM-6
140 mm

Spitz
Sharp
Acute
Agudo
Pointu

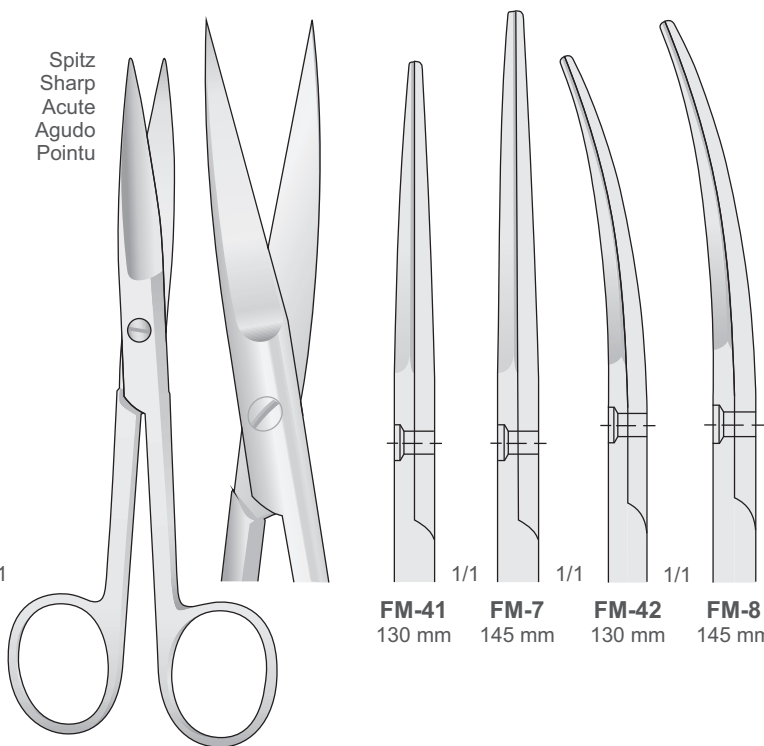

FM-41
130 mm

FM-7
145 mm

FM-42
130 mm

FM-8
145 mm

MAYO
FM-5/FM-6
140 mm

FM-7/FM-42

SUPER CUT



Regular
Edge



**SUPER CUT
Edge**

Super Cut Scissors have specially designed cutting edges.
One regular edge and **one sharp-knife edge**.



Extremely Sharp Razor Edge / Atraumatic
 Extrem Scharfe Spitzer Beck / Atraumatische
 Tranchant extrêmement aiguisée / Atraumatische
 Borde extremadamente afilado / Atraumática
 Taglio estremamente affilato / Atraumatica



One side serrated
 Eine seite gezahnt
 Un côté dentelé
 Un lado dentado
 Un lato dentellato

SCISSORS

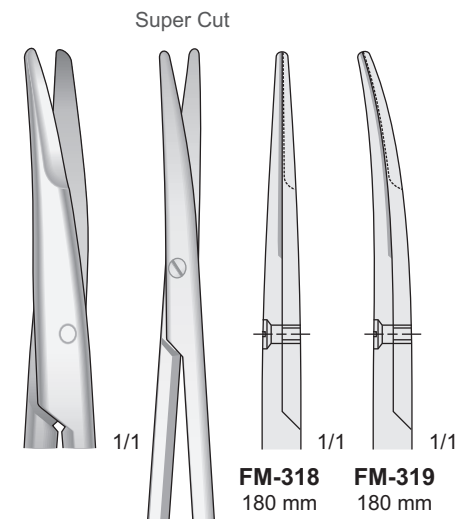

METZENBAUM
FM-318/FM-319
180 mm

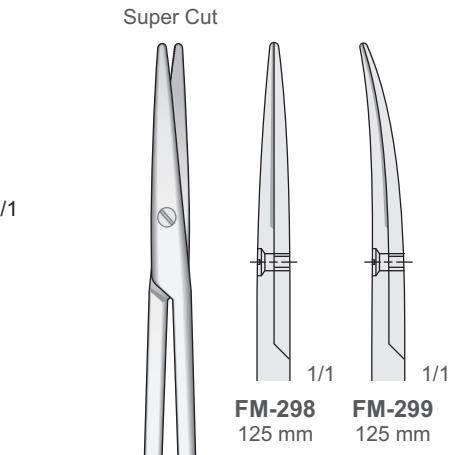

METZENBAUM
FM-298/FM-299
125 mm

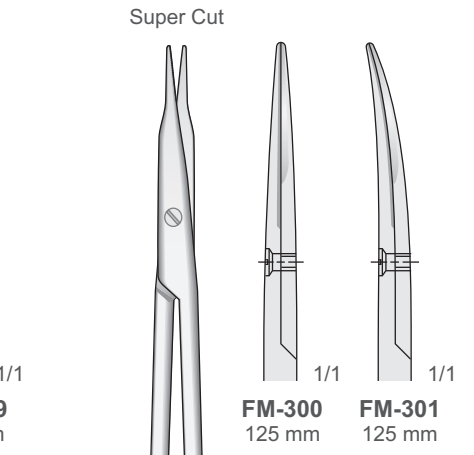

STEVENS
FM-300/FM-301
125 mm

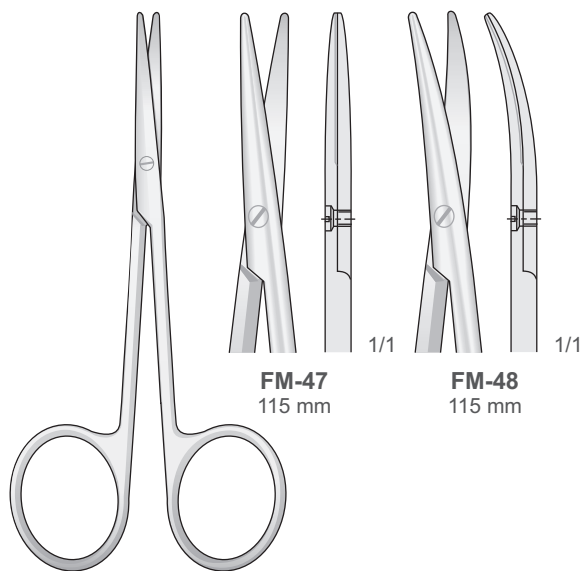

FM-47
115 mm

FM-48
115 mm

BABY - METZENBAUM
FM-47/FM-48
115 mm

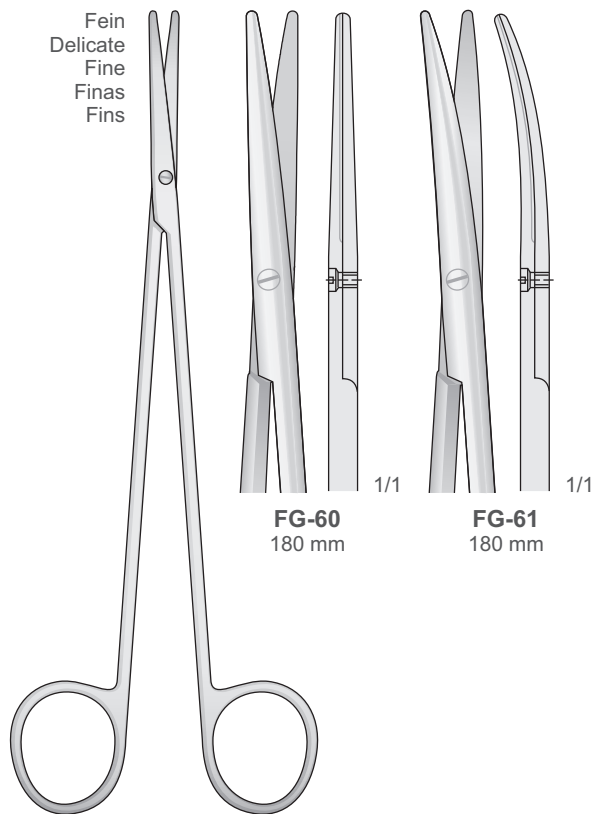

Fein
Delicate
Fine
Finas
Fins

FG-60
180 mm

FG-61
180 mm

TOENNIS-ADSON
FG-60/FG-61
180 mm

Präparierscheren - Dissecting Scissors
Forbici per dissezione - Tijeras de disección - Ciseaux à dissection

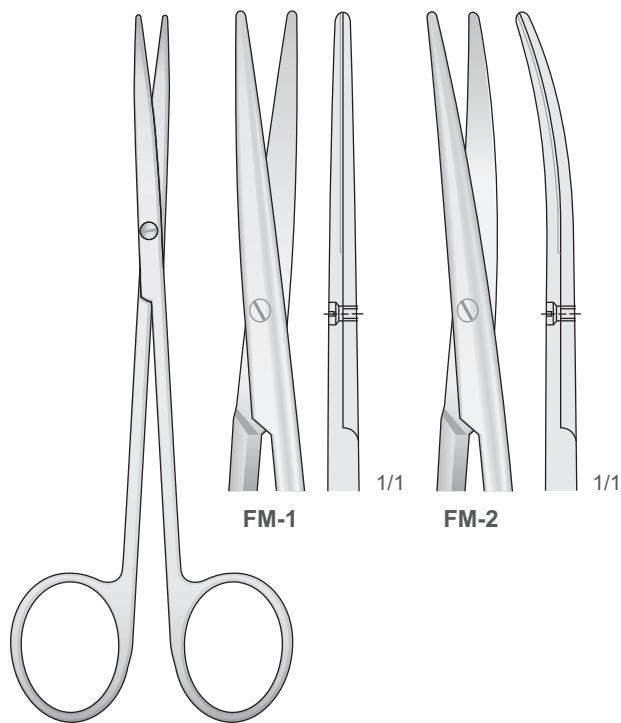

FM-1

FM-2

METZENBAUM
FM-1/FM-2
145 mm

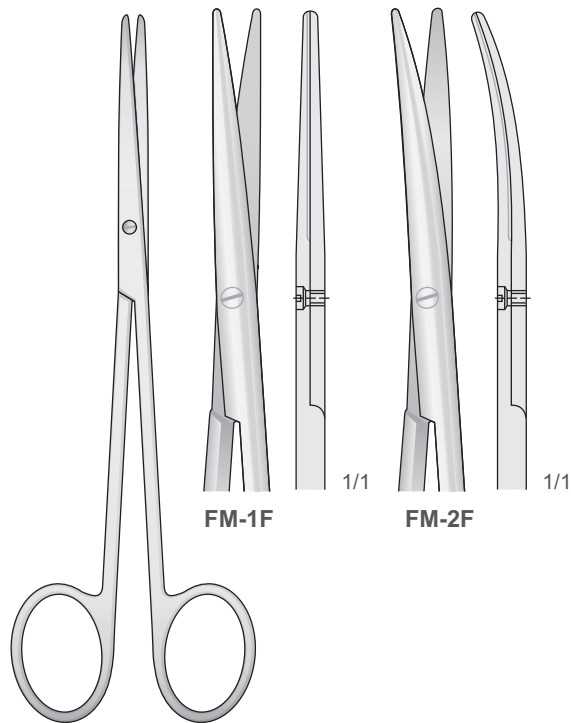

FM-1F

FM-2F

METZENBAUM-FINO
FM-1F/FM-2F
145 mm

Scheren
Scissors
Forbici
Tijeras
Ciseaux

SCISSORS

TC

TC

FM-66 **FM-67**

METZENBAUM
FM-66/FM-67
145 mm

TC
TUNGSTEN
CARBIDE

Tungsten-Carbide Inserts
Mit Hartmetalleinsätzen
Plaquettes en carbure de tungstène
Plaquetas de carburo de tungsteno
Inserti in carburo di tungsteno

TC

FM-68 **FM-69**

METZENBAUM
FM-68/FM-69
185 mm

FM-3 **FM-4**

METZENBAUM
FM-3/FM-4
185 mm

FM-3F **FM-4F**

METZENBAUM-FINO
FM-3F/FM-4F
185 mm

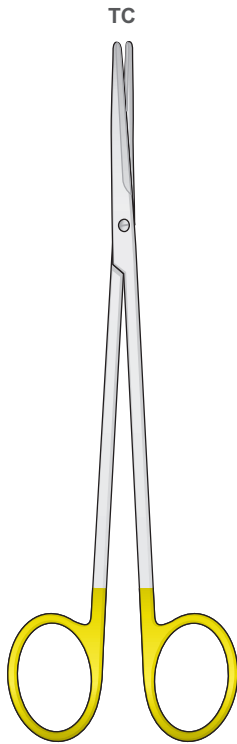

METZENBAUM-FINO
FM-201/FM-204

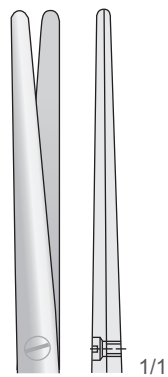

FM-201
140 mm

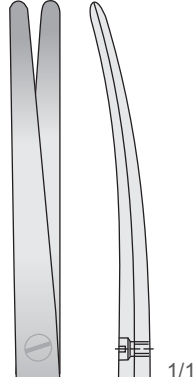

FM-202
140 mm

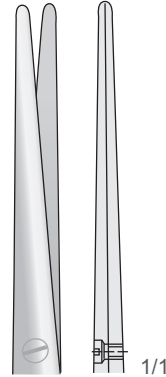

FM-203
180 mm

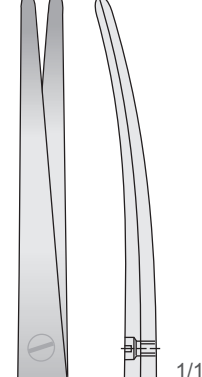

FM-204
180 mm



Tungsten-Carbide Inserts
Mit Hartmetalleinsätzen
Plaquettes en carbure de tungstène
Plaquetas de carburo de tungsteno
Inserti in carburo di tungsteno

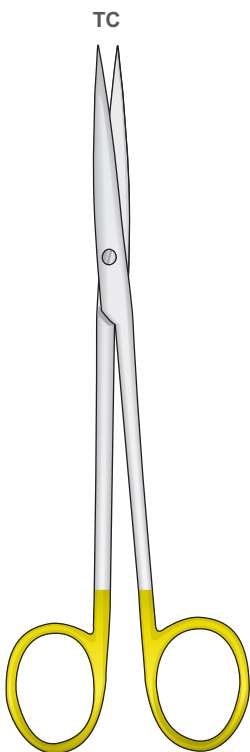

METZENBAUM-FINO
FM-96/FM-99

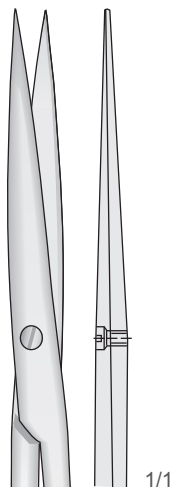

FM-96
140 mm

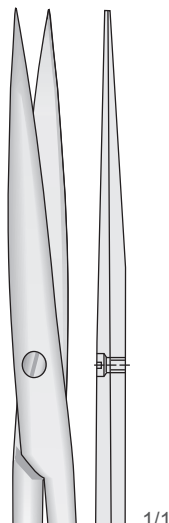

FM-97
180 mm

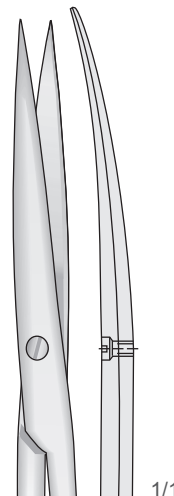

FM-98
140 mm

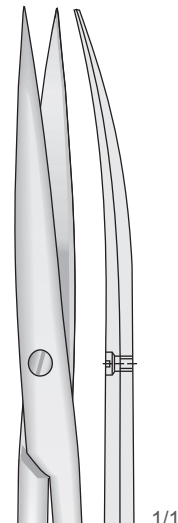

FM-99
180 mm

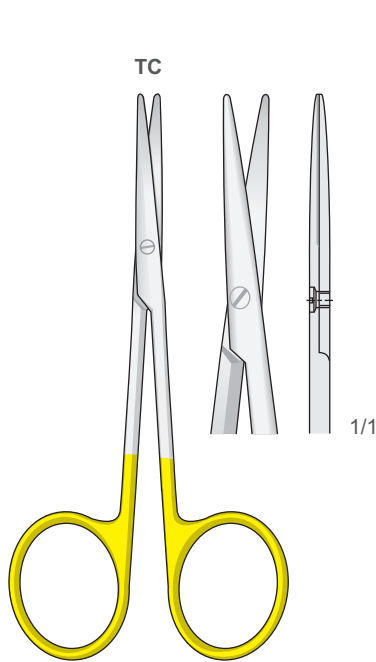

BABY-METZENBAUM
FM-118
115 mm

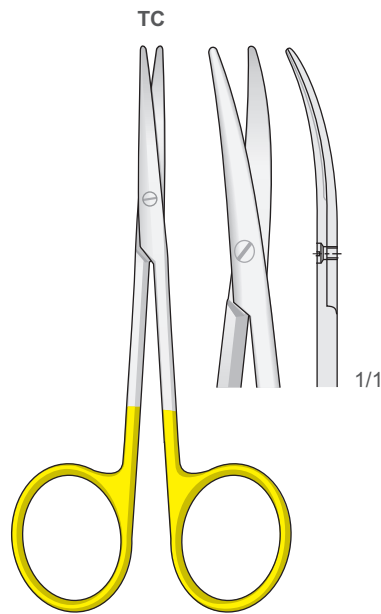

BABY-METZENBAUM
FM-119
115 mm

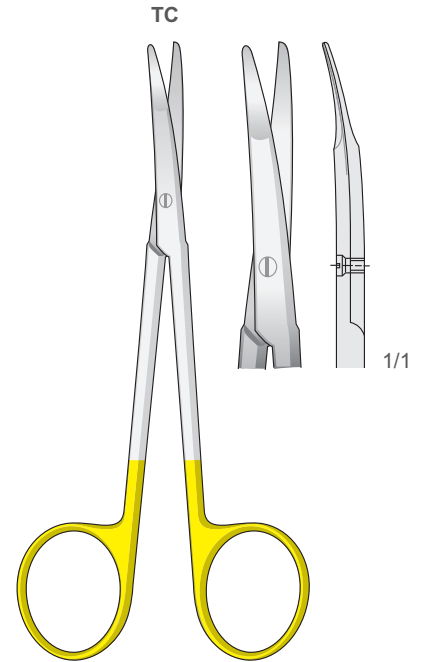

KILNER
FM-350
125 mm

Gebogen - Curved
Curva - Curvas
Courbes

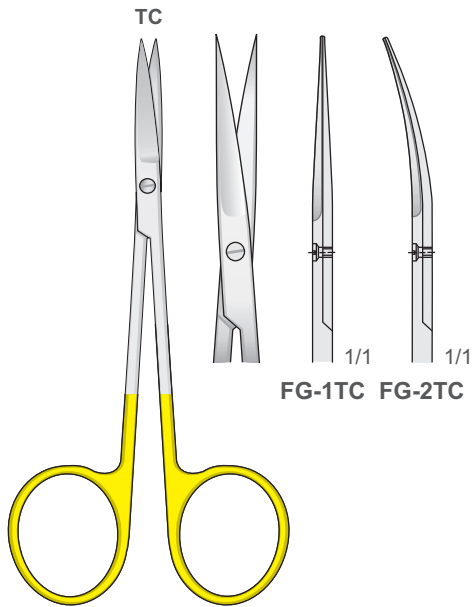

IRIS
FG-1TC/FG-2TC
115 mm

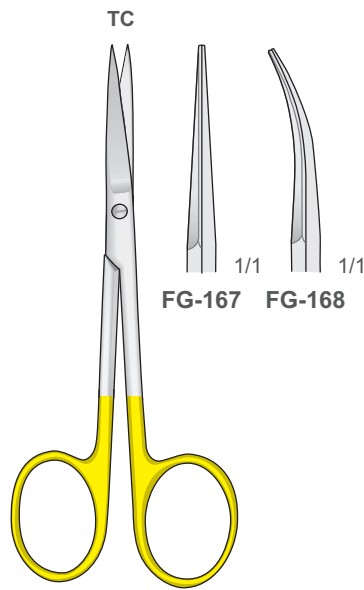

FG-167/FG-168
110 mm

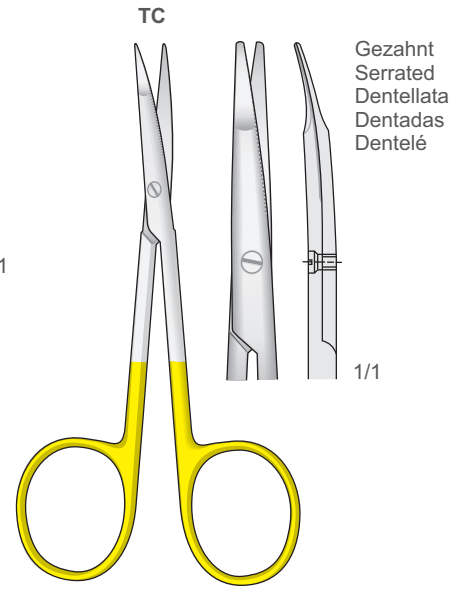

GREENBERG-PAR
FM-317
115 mm

Gezahnt
Serrated
Dentellata
Dentadas
Dentelé



1/1
One side serrated
Eine seite gezahnt
Un côté dentelé
Un lado dentado
Un lato dentellato

LK-10
160 mm

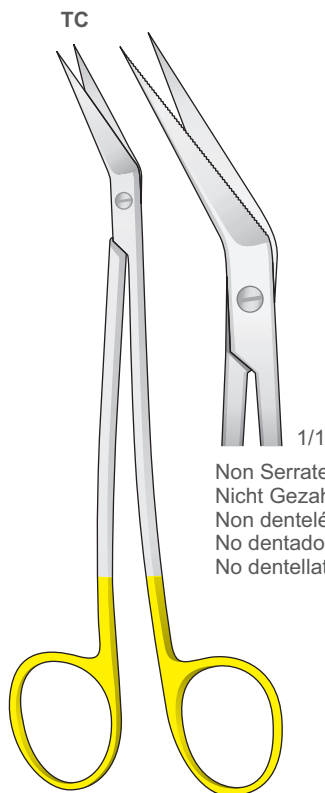

1/1
Non Serrated
Nicht Gezahnt
Non dentelé
No dentado
No dentellato

LK-12
160 mm



Tungsten-Carbide Inserts
Mit Hartmetalleinsätzen
Plaquettes en carbure de tungstène
Plaquetas de carburo de tungsteno
Inserti in carburo di tungsteno

Eine Schneide gezahnt S-förmig gebogen
One toothed cutting edge S-shaped
Una lama dentata curva a forma S
Una hoja dentada forma S
Une lame dentelée courbés en S

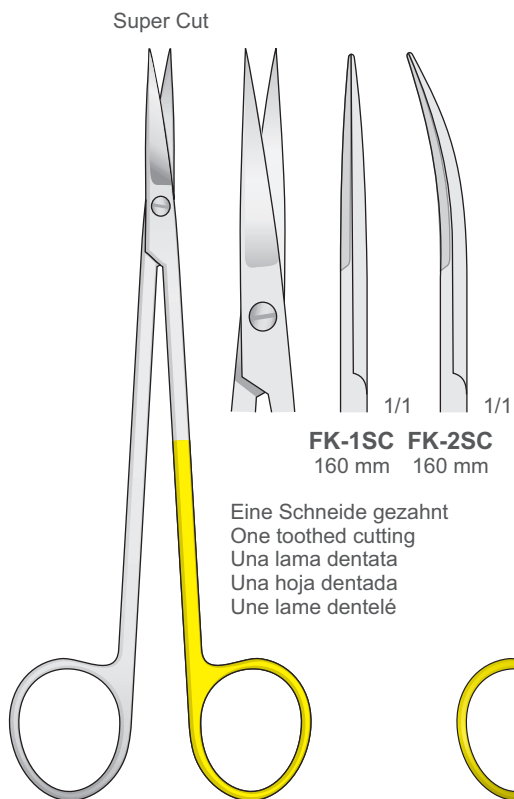

Eine Schneide gezahnt
One toothed cutting
Una lama dentata
Una hoja dentada
Une lame dentelé

KELLY
FK-1SC/FK-2SC
160 mm

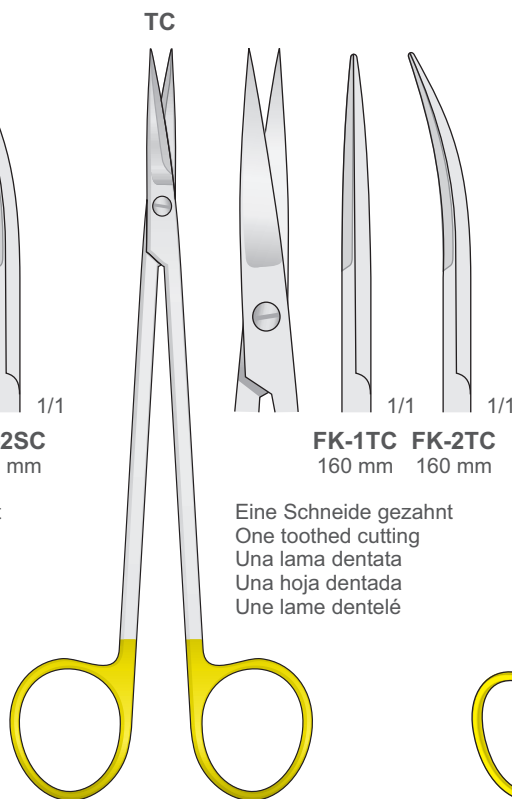

Eine Schneide gezahnt
One toothed cutting
Una lama dentata
Una hoja dentada
Une lame dentelé

KELLY
FK-1TC/FK-2TC
160 mm

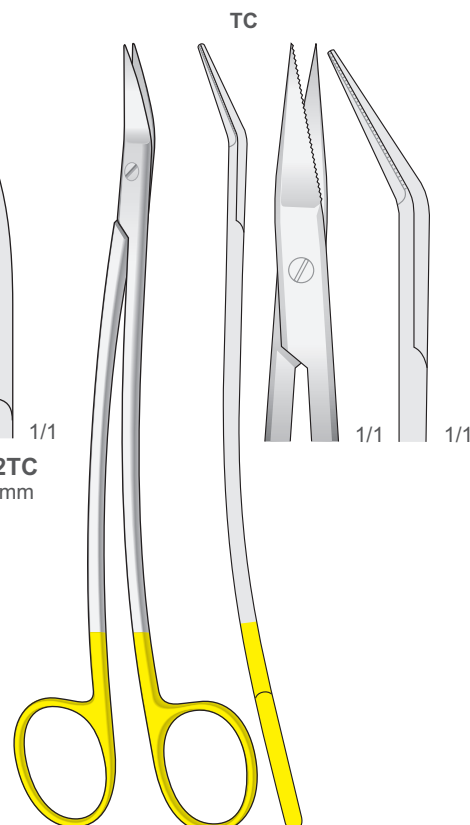

DEAN-TC
175 mm

Scheren
Scissors
Forbici
Tijeras
Ciseaux

Wellenschliff
TC

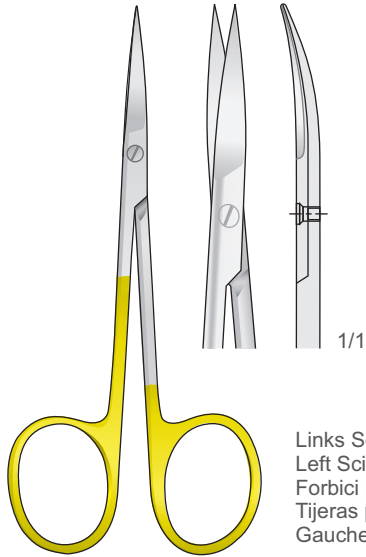

Links Scheren
Left Scissors
Forbici per mancini
Tijeras para zurdos
Gauche Ciseaux

IRIS
FM-100L
110 mm

TC
TUNGSTEN
CARBIDE

Tungsten-Carbide Inserts
Mit Hartmetalleinsätzen
Plaquettes en carbure de tungstène
Plaquetas de carburo de tungsteno
Inserti in carburo di tungsteno

SCISSORS

Wellenschliff
TC

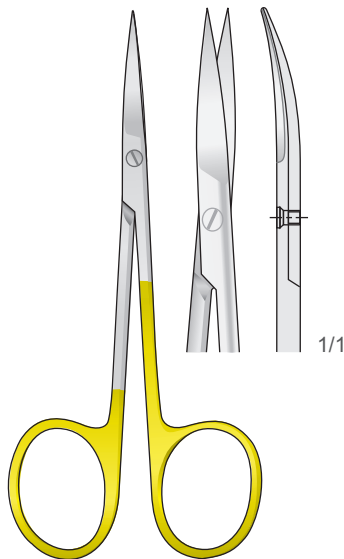

IRIS
FM-100
110 mm

Wellenschliff
TC

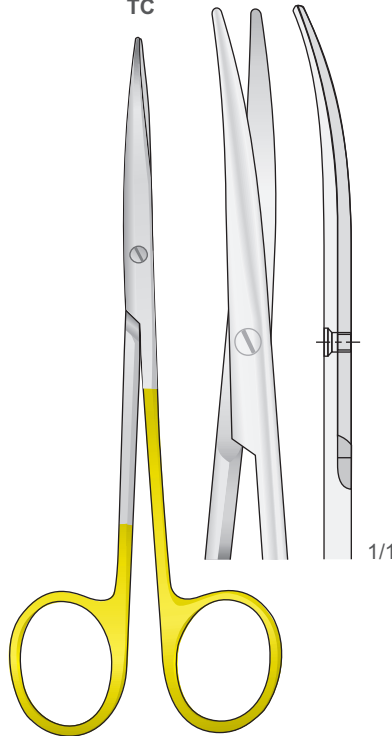

METZENBAUM
FM-102
145 mm

Wellenschliff
TC

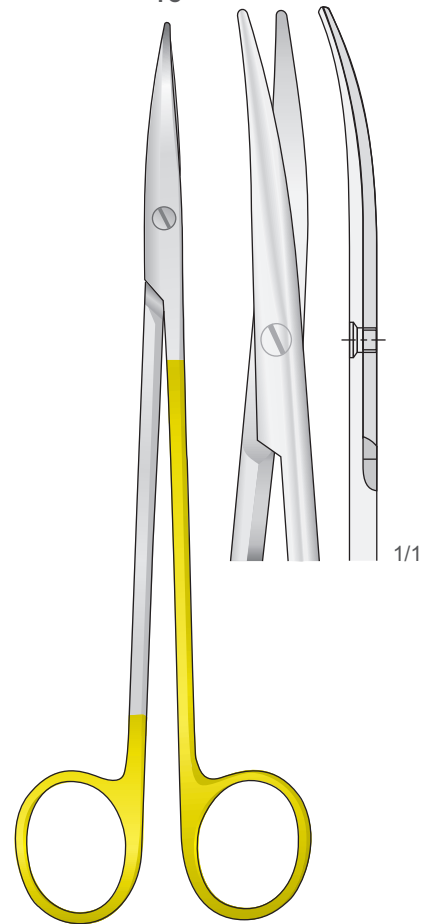

METZENBAUM
FM-104
185 mm

 **Extremely Sharp Razor Edge / Atraumatic**
 Extrem Scharfe Spitzer Beck / Atraumatische
 Tranchant extrêmement aiguisée / Atraumatique
 Borde extremadamente afilado / Atraumática
 Taglio estremamente affilato / Atraumatica

SCISSORS

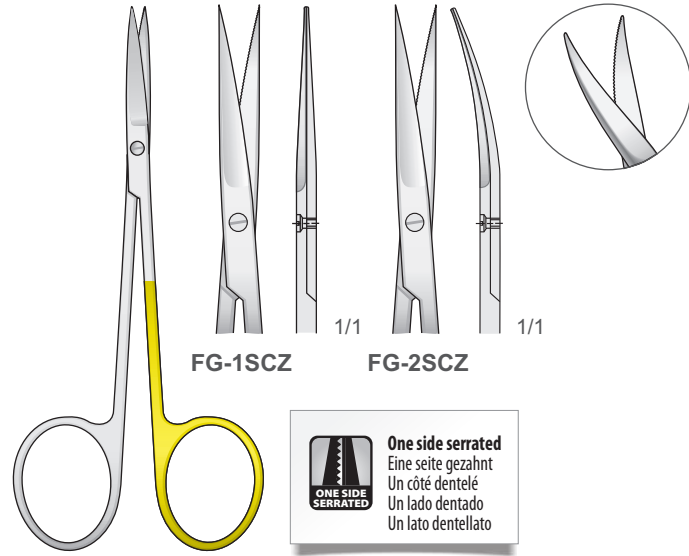

FG-1SCZ/FG-2SCZ
110 mm

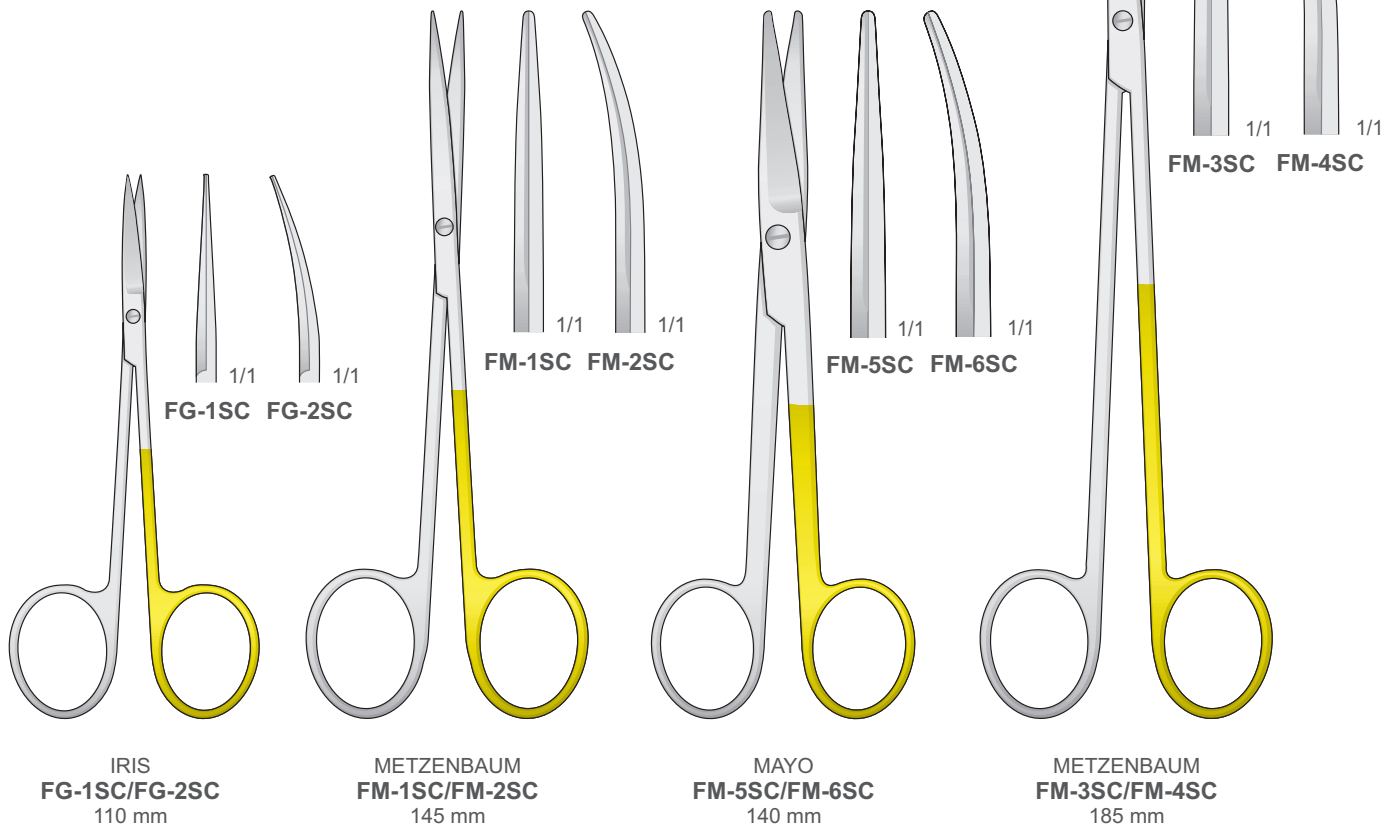

SUPER CUT



Super Cut Scissors have specially designed cutting edges.
One regular edge and **one sharp-knife edge.**



Extremely Sharp Razor Edge / Atraumatic
Extrem Scharfe Spitzer Beck / Atraumatische
Tranchant extrêmement aiguïlée / Atraumatique
Borde extremadamente afilado / Atraumática
Taglio estremamente affilato / Atraumatica



One side serrated
Eine seite gezahnt
Un côté dentelé
Un lado dentado
Un lato dentellato

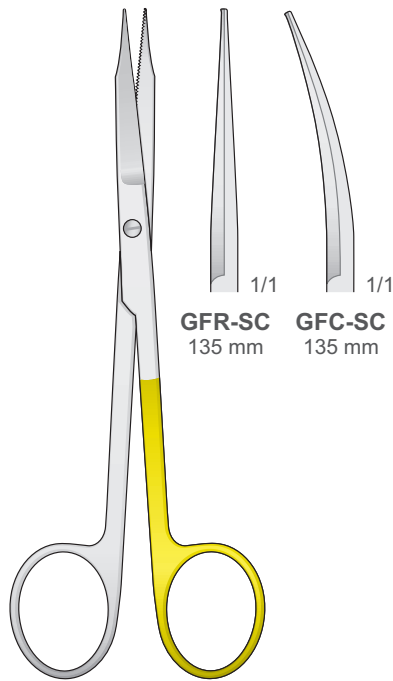

GOLDMAN-FOX
GFR-SC/GFC-SC
135 mm

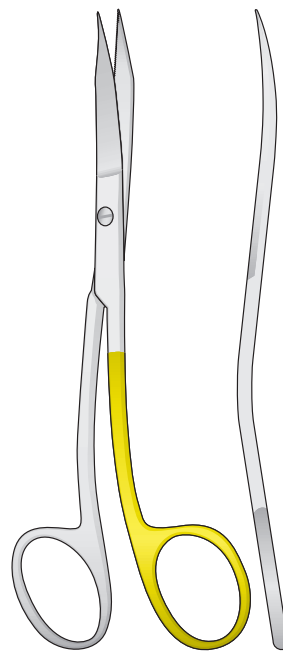

GOLDMAN-FOX S FORM
GFS-SC
130 mm

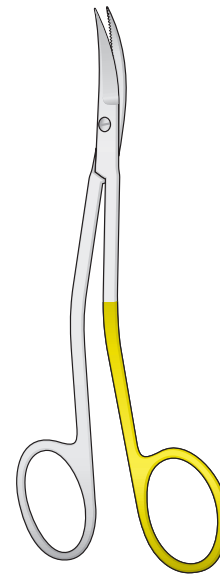

LA GRANGE
LG-1SC/LG-2SC
115 mm

Spitz
Sharp
Acute
Agudas
Pointu

Stumpf
Blunt
Smusse
Romas
Mousse

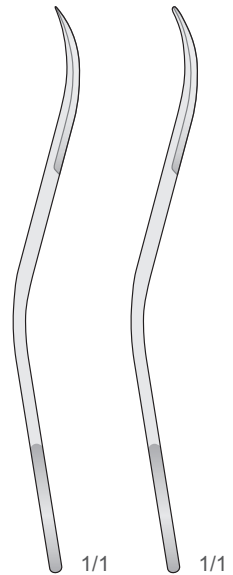

LA GRANGE
LG-1SC **LA GRANGE**
LG-2SC

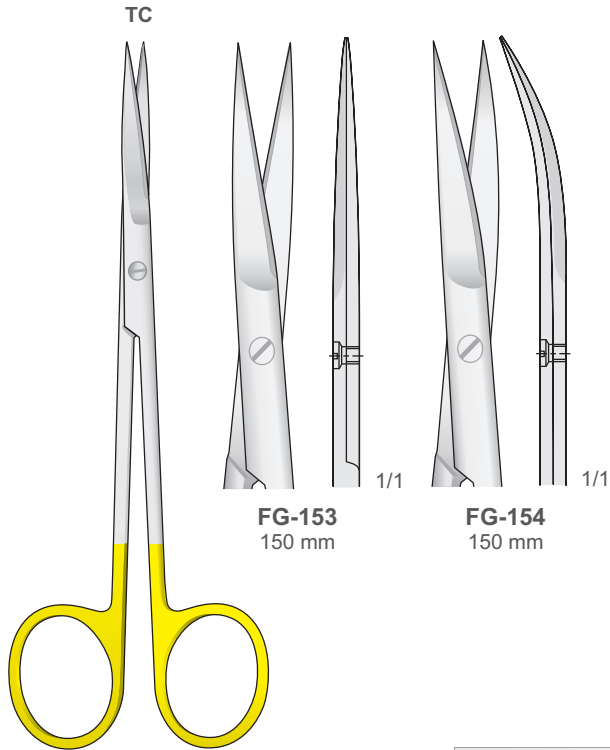

JOSEPH
FG-153/FG-154
150 mm



Tungsten-Carbide Inserts
Mit Hartmetalleinsätzen
Plaquettes en carbure de tungstène
Plaquetas de carburo de tungsteno
Inserti in carburo di tungsteno



One side serrated
Eine seite gezahnt
Un côté dentelé
Un lato dentado
Un lato dentellato



One side serrated
Eine seite gezahnt
Un côté dentelé
Un lato dentado
Un lato dentellato

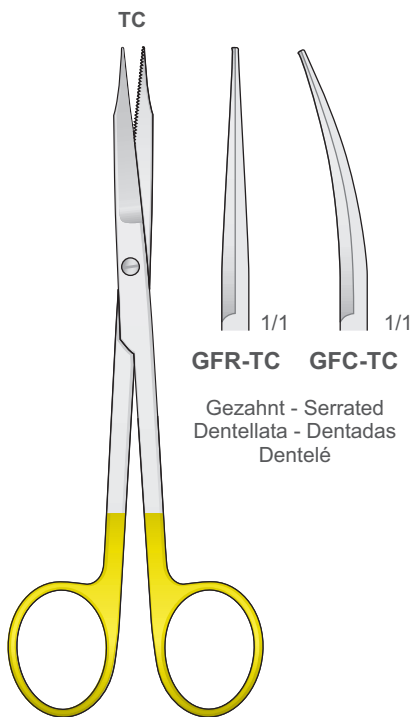

GOLDMAN-FOX
GFC-TC/GFR-TC
135 mm

Gezahnt - Serrated
Dentellata - Dentadas
Dentelé

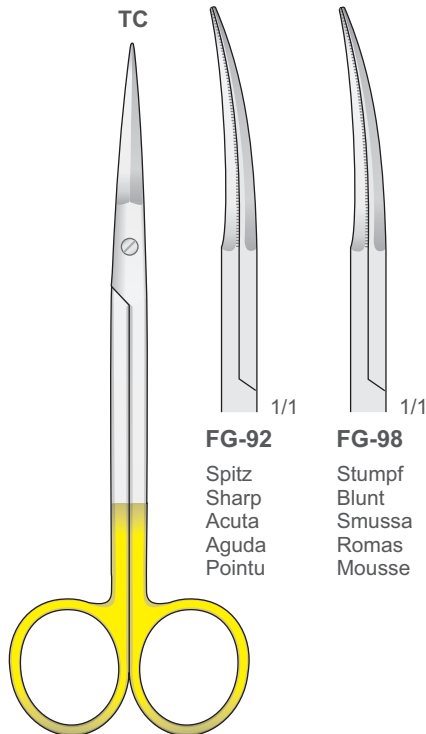

PECK-JOSEPH
FG-92/FG-98
140 mm

FG-92
Spitz
Sharp
Acuta
Aguda
Pointu

FG-98
Stumpf
Blunt
Smussa
Romos
Mousse

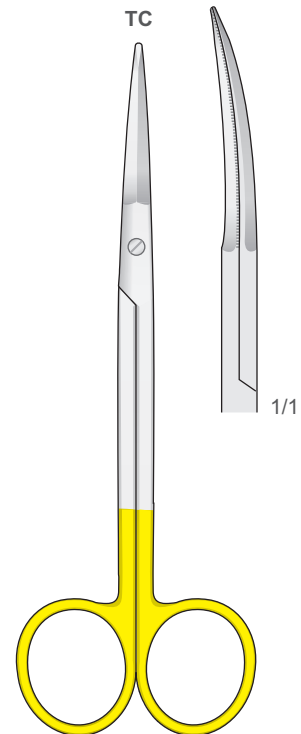

GREGORY
FM-339
140 mm

Scheren
Scissors
Forbici
Tijeras
Ciseaux

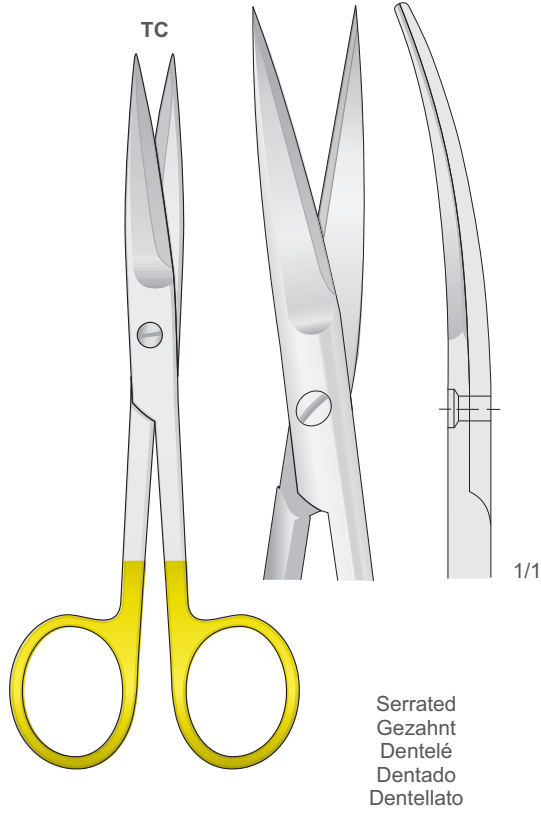

TC
TUNGSTEN
CARBIDE

Tungsten-Carbide Inserts
Mit Hartmetalleinsätzen
Plaquettes en carbure de tungstène
Plaquetas de carburo de tungsteno
Inserti in carburo di tungsteno

Serrated
Gezahnt
Dentelé
Dentado
Dentellato

FM-146
145 mm

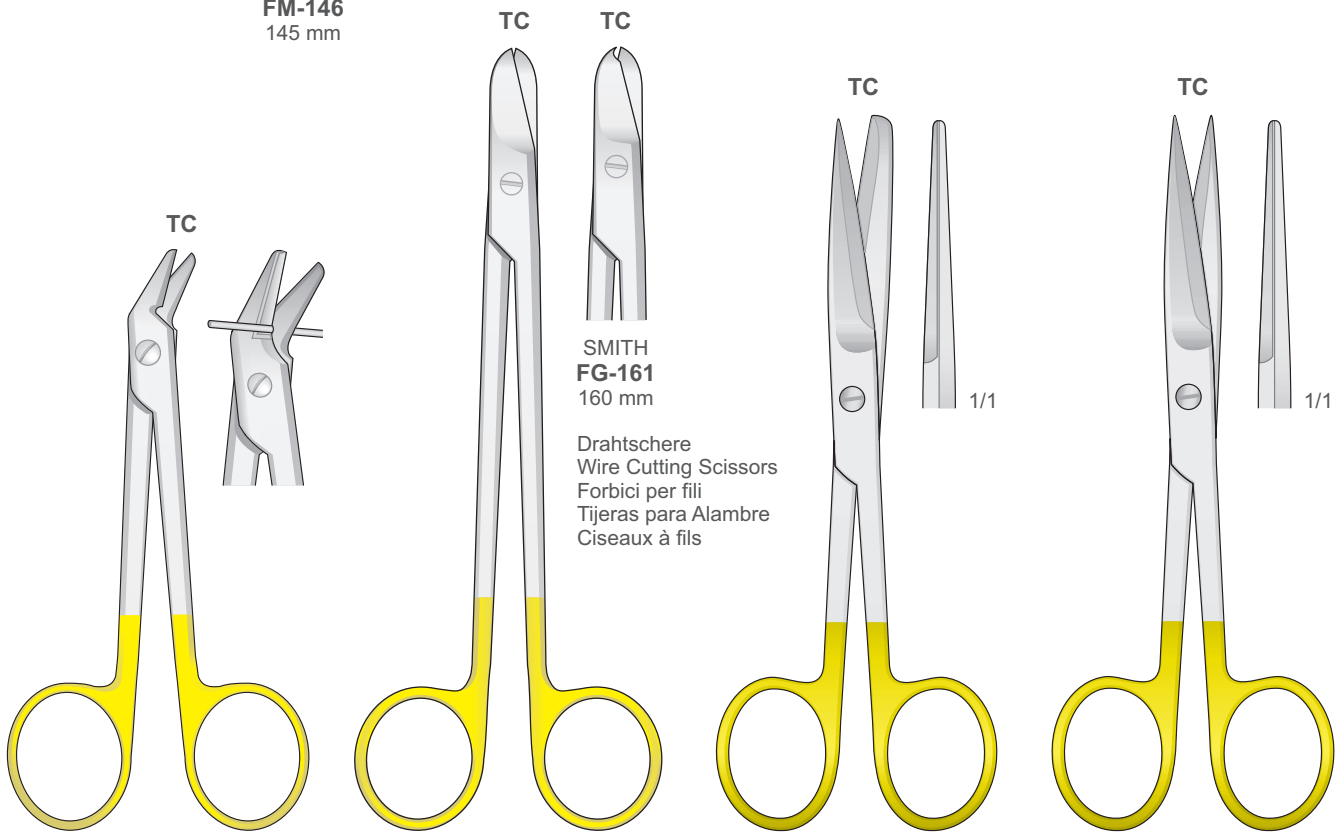

DP-120
120 mm

**SMITH
FG-160**
160 mm

FM-51
145 mm

FM-59
145 mm

**SMITH
FG-161**
160 mm

Drahtschere
Wire Cutting Scissors
Forbici per fili
Tijeras para Alambre
Ciseaux à fils

SCISSORS

Ligature Scissors

Ligatur Scheren
 Ligature Scissors
 Forbici per legature
 Tijeras para ligaduras
 Ciseaux à ligatures

SCISSORS

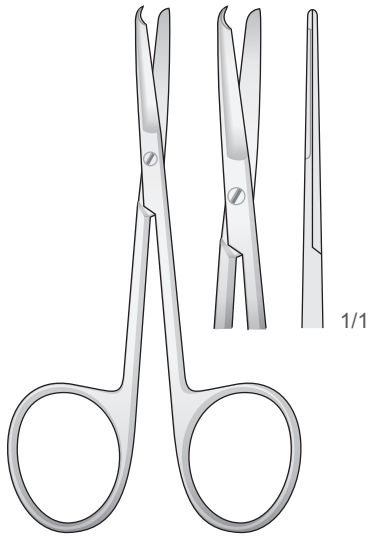

SPENCER
SC-9
 90 mm

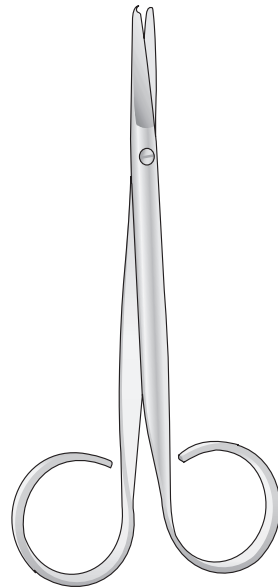

SPENCER
SC-1
 110 mm



SPENCER
SC-5
 110 mm

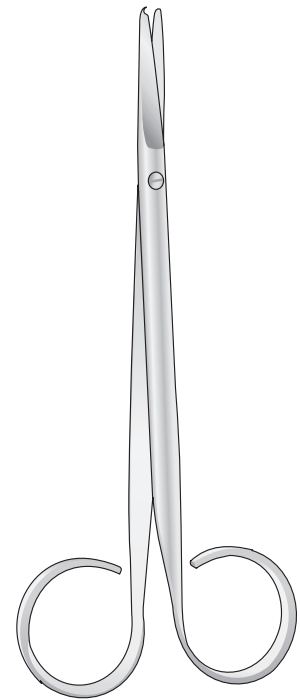

SPENCER
SC-2
 145 mm

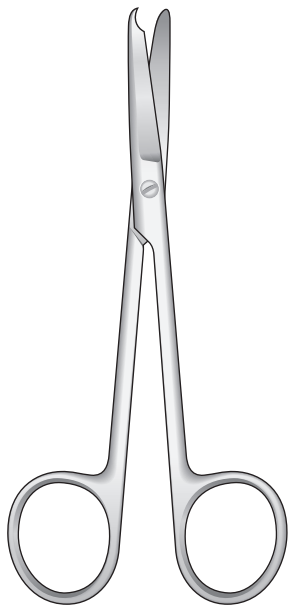

SPENCER
SC-14
 120 mm

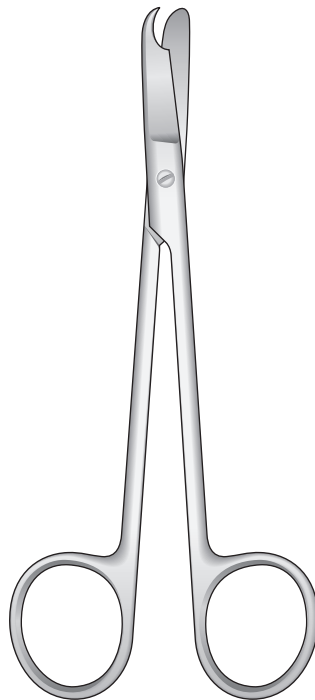

LITTAUER
SC-15
 140 mm

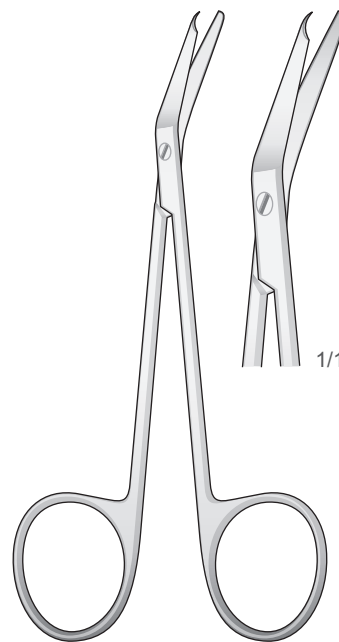

SPENCER
SC-13
 130 mm

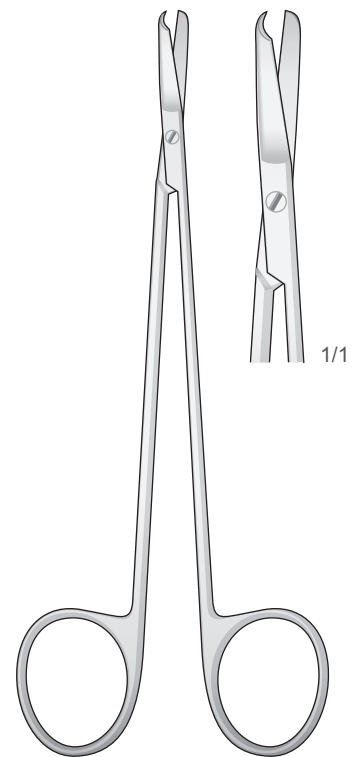

KELLY
SC-16
 150 mm

Draht und blechscheren
 Wire and plate cutting scissors
 Forbici per fili metallici
 Tijeras para cortar alambre
 Ciseaux coupe-fils métalliques

Wire and Plate

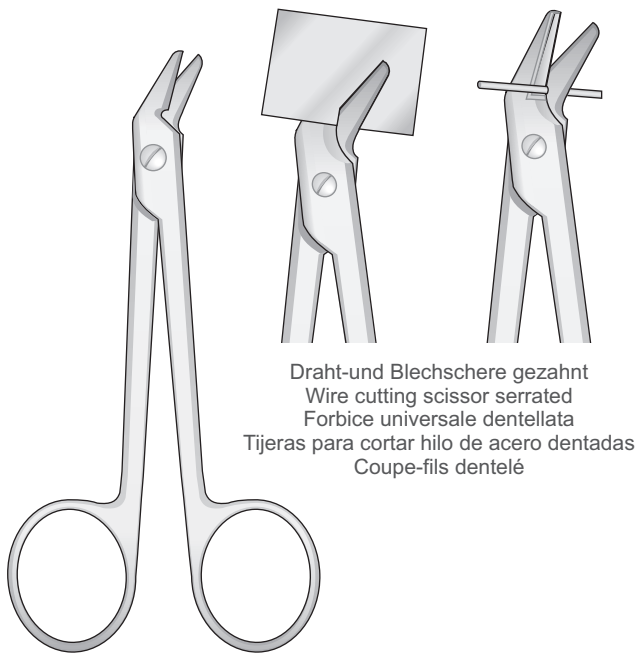

DP-90
120 mm

Draht-und Blehschere gezahnt
 Wire cutting scissor serrated
 Forbice universale dentellata
 Tijeras para cortar hilo de acero dentadas
 Coupe-fils dentelé

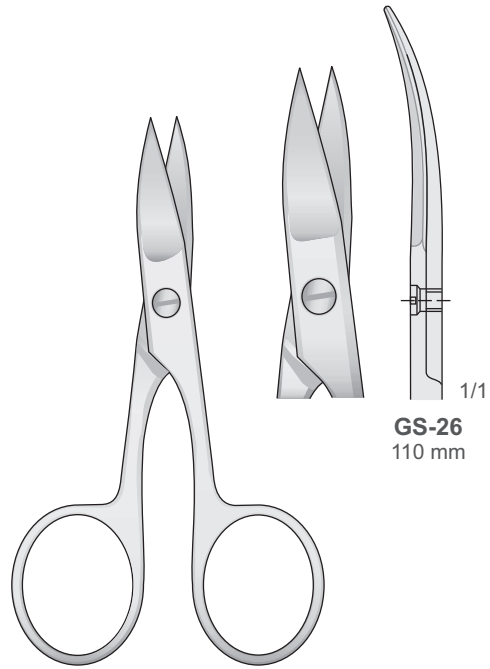

GS-26
110 mm

GS-26
110 mm

Spitz
 Sharp
 Acute
 Agudas
 Pointu



BEEBE
DP-91/DP-101
110 mm

Stumpf
 Blunt
 Smusse
 Romas
 Mousse

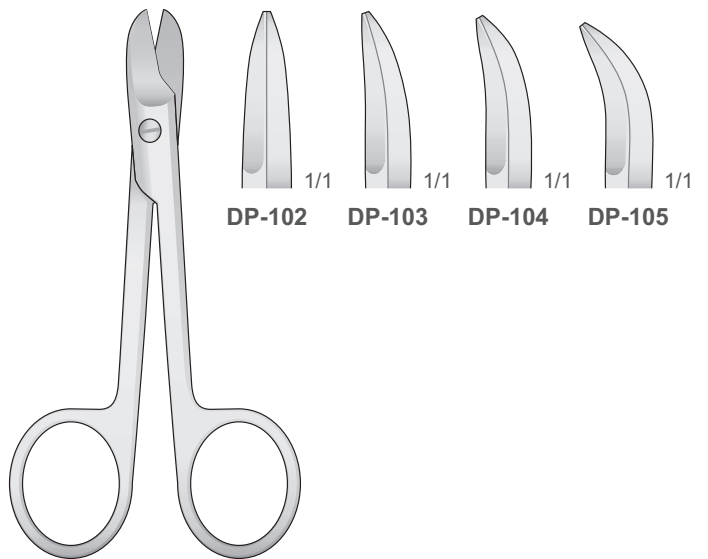

BEEBE
DP-102/DP-105
110 mm

SCISSORS

• Tweezers

113 | Micro Forceps

118 | Titanium Forceps

120 | Dressing Forceps

121 | Endo Forceps

122 | Tissue Forceps

136 | TC Forceps / Atraumatic

138 | Membrane



Mikro Pinzetten
 Delicate Forceps
 Micro Pinzette
 Pinzas finas
 Micro Pincers

Micro Forceps

0,2 mm

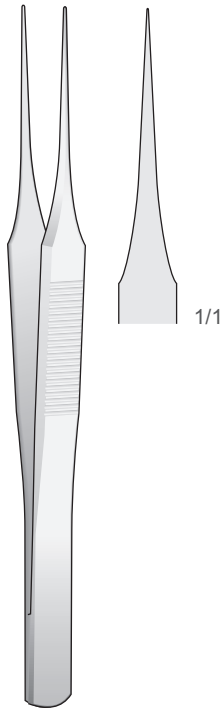

BD-360
110 mm

0,3 mm

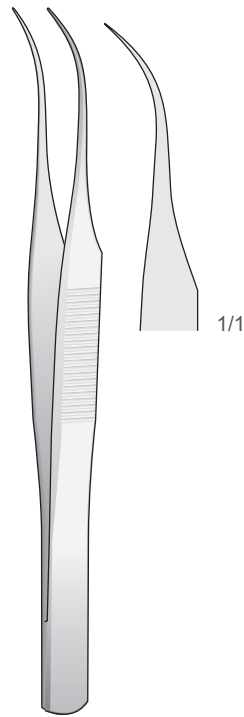

BD-361
110 mm

0,25 mm

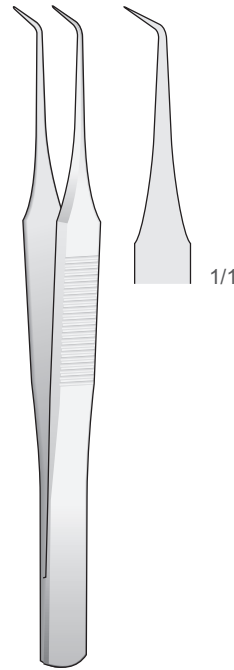

BD-362
100 mm

0,15 mm

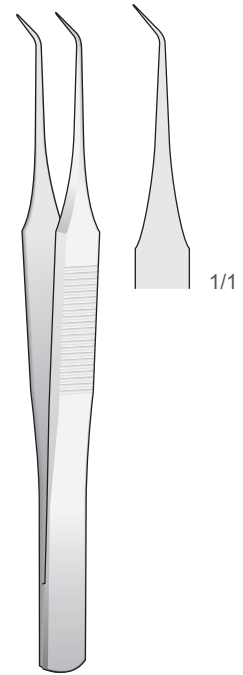

BD-363
100 mm

0,4 mm

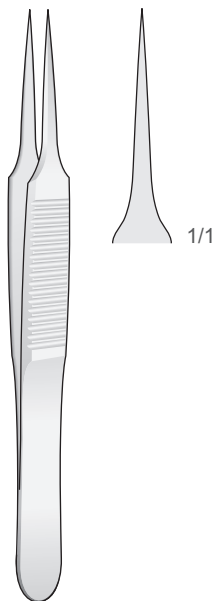

BD-364
110 mm

0,4 mm

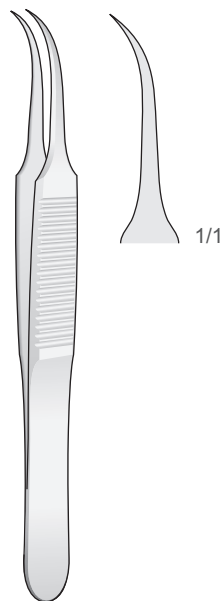

BD-365
110 mm

0,4 mm

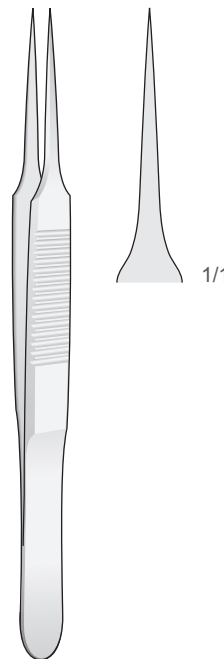

BD-366
130 mm

0,4 mm

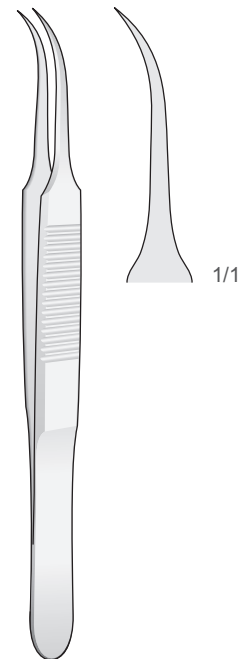

BD-367
130 mm

TWEEZERS

Mikro Pinzetten
Delicate Forceps
Micro Pinzette
Pinzas finas
Micro Pincers



Diamond Tip
Diamantiert
Punta diamantata
Punta de diamante
Pointe de diamant

TWEEZERS

Tissue Forceps
1x2 Teeth

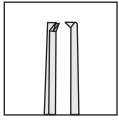

BISHOP-HARMON
MF-177 1,2 mm
85 mm

Dressing Forceps
criss-cross serrated tips

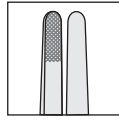

BISHOP-HARMON
MF-249 1,2 mm
85 mm

1/1

1/1

1x2 Zähne
1x2 Teeth
1x2 Denti
1x2 Dientes
1x2 Dents



CASTROVIEJO
BD-348 0.9 mm
120 mm

1/1

9x9 Zähne
9x9 Teeth
9x9 Denti
9x9 Dientes
9x9 Dents



BROWN
BD-349
120 mm

1,2 mm

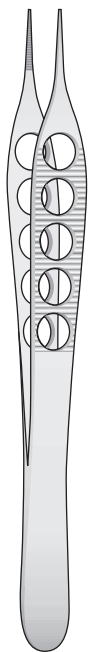

ADSON
BD-207
120 mm

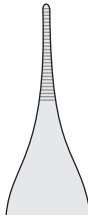

1/1

1,2 mm

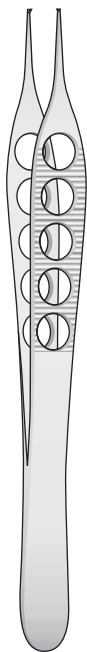

ADSON
BD-208
120 mm

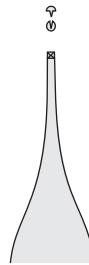

1/1

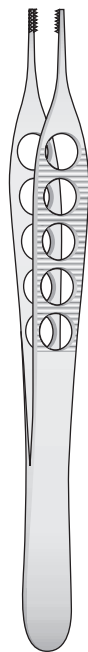

ADSON-BROWN
BD-209
120 mm



1/1

7x7 Zähne
7x7 Teeth
7x7 Denti
7x7 Dientes
7x7 Dents

TC

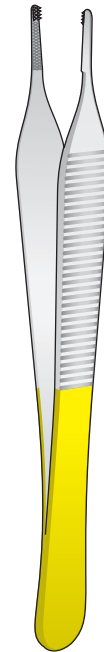

ADSON-BROWN
BD-253
120 mm

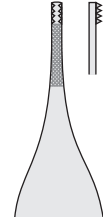

1/1

Mikro Pinzetten
 Delicate Forceps
 Micro Pinzette
 Pinzas finas
 Micro Pincers

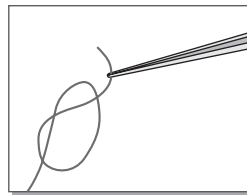

TWEEZERS

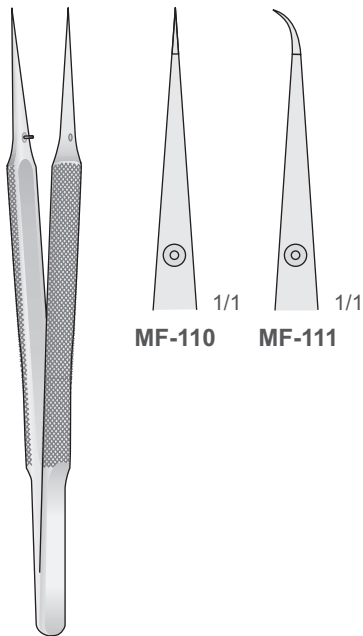

MF-110 1/1 **MF-111** 1/1

MF-110/MF-111
120 mm

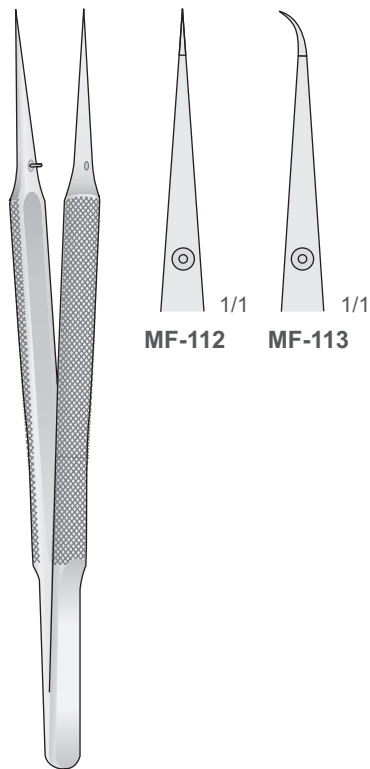

MF-112 1/1 **MF-113** 1/1

MF-112/MF-113
150 mm

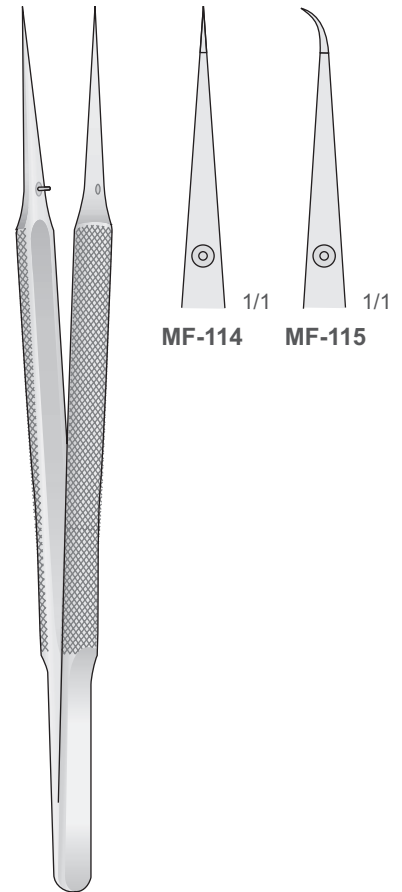

MF-114 1/1 **MF-115** 1/1

MF-114/MF-115
180 mm

Mikro Pinzette - Rundgriff Ø 8 mm
 Mit Führungsstift diamantiert
 Fadenplatte 6x0,7 mm

Mikro Pinzetten
 Micro Forceps
 Micro Pinzette
 Micro Pinzas
 Micro Pincers



TWEEZERS

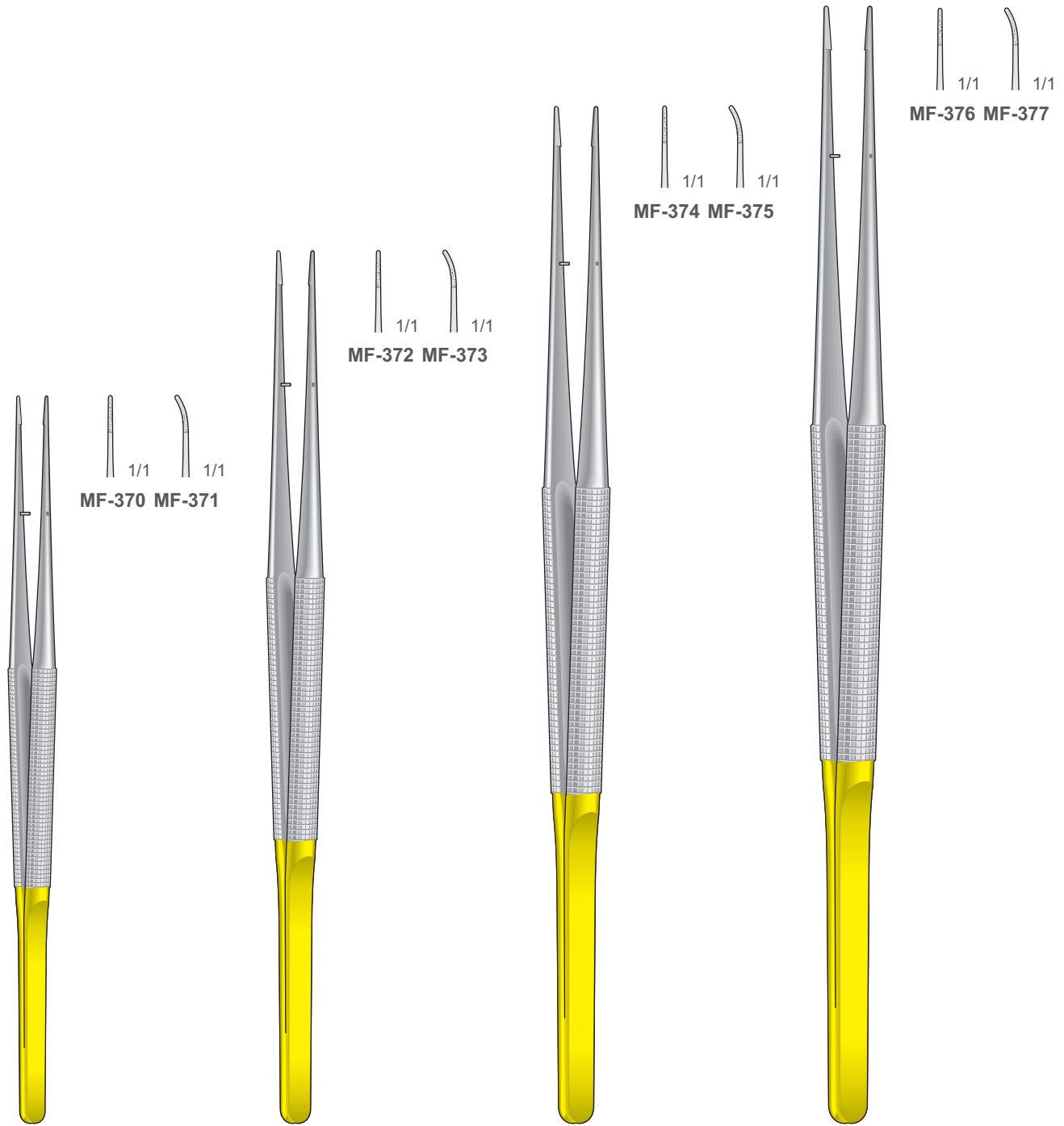

MF-370/MF-371
 150 mm

MF-372/MF-373
 180 mm

MF-374/MF-375
 210 mm

MF-376/MF-377
 230 mm

Mikro Pinzetten
 Micro Forceps
 Micro Pinzette
 Micro Pinzas
 Micro Pincers

Mikro Pinzette - Rundgriff Ø 8 mm
 Mit Führungsstift diamantiert
 Fadenplatte 6x0,7 mm



Diamond Tip
 Diamantiert
 Punta diamantata
 Punta de diamante
 Pointe de diamant

1x2 Zähne
 1x2 Teeths
 1x2 Denti
 1x2 Dientes
 1x2 Dents

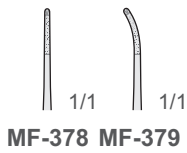

MF-378 MF-379

1x2 Zähne
 1x2 Teeths
 1x2 Denti
 1x2 Dientes
 1x2 Dents



MF-380 MF-381

1x2 Zähne
 1x2 Teeths
 1x2 Denti
 1x2 Dientes
 1x2 Dents



MF-382 MF-383

1x2 Zähne
 1x2 Teeths
 1x2 Denti
 1x2 Dientes
 1x2 Dents

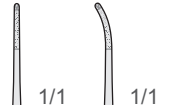

MF-384 MF-385

MF-378/MF-379
 150 mm

MF-380/MF-381
 180 mm

MF-382/MF-383
 210 mm

MF-384/MF-385
 230 mm

TWEEZERS

Titanium Forceps

Titan-Pinzetten
Titanium Tissue Forceps
Pinzette in titanio
Pinzas de titanio
Pincas en titane



Titanium
Titan
Titane
Titanio
Titano

TWEEZERS

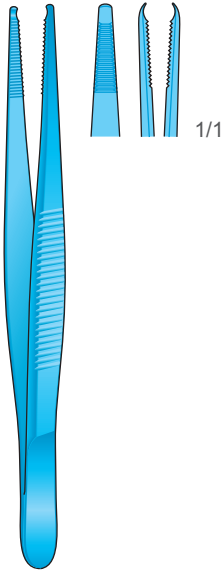

BD-285T
90 mm

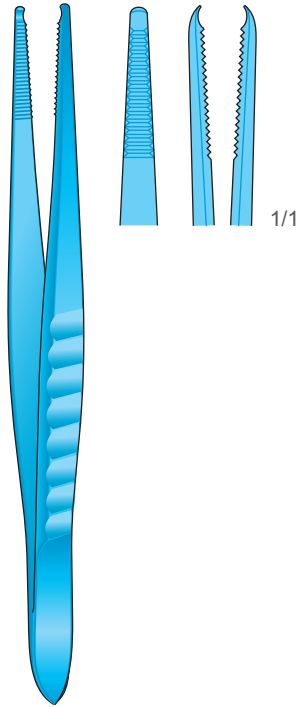

BD-270T
130 mm

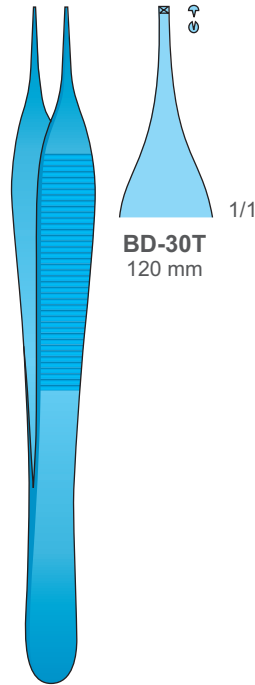

ADSON
BD-30T
120 mm

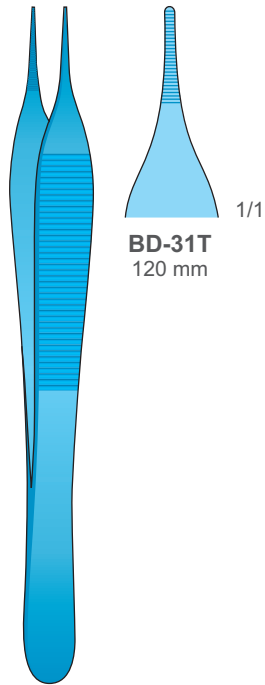

ADSON
BD-31T
120 mm

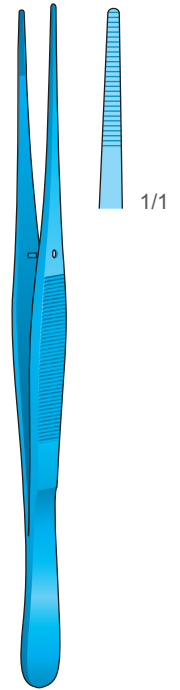

BD-09T
130 mm

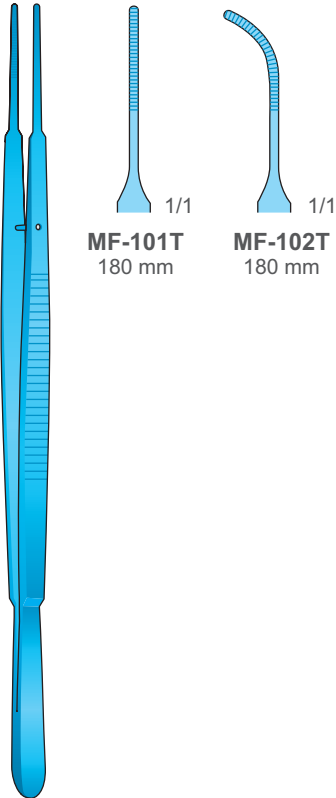

GERALD
MF-101T/MF-102T
180 mm

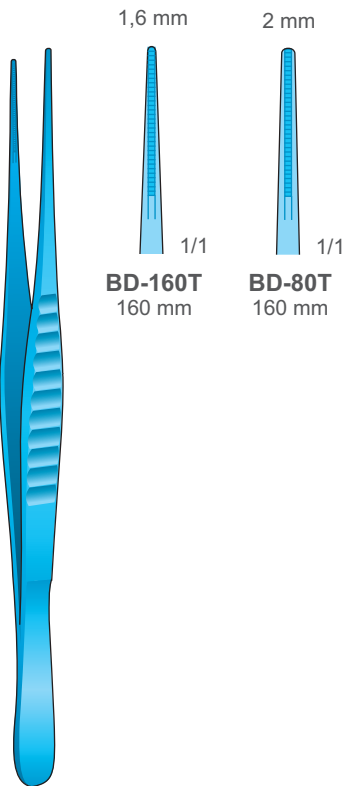

DE BAKEY
BD-80T/BD-160T

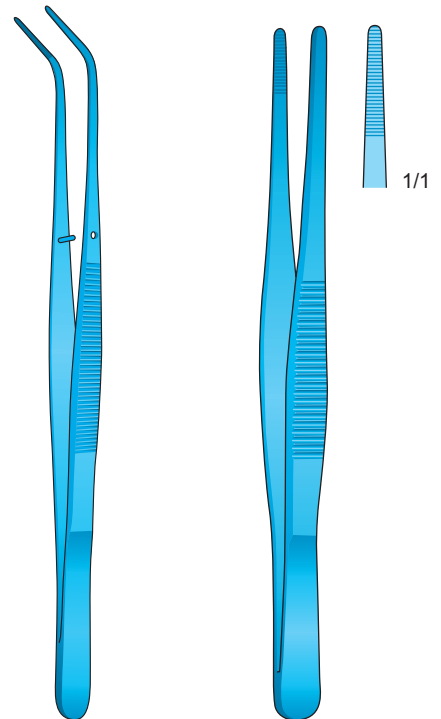

COLLEGE
TT-01
150 mm

BD-75T
145 mm

Mikro Pinzetten
 Delicate Forceps
 Micro Pinzette
 Pinzas finas
 Micro Pincers

Rund-Griffe Ø 8 mm
 Round handle Ø 8 mm
 Manico rotondo Ø 8 mm
 Mango redondo Ø 8 mm
 Manche rond Ø 8 mm

TWEEZERS

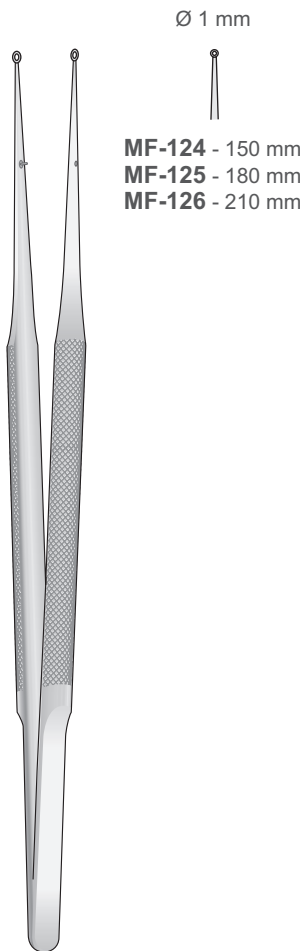

MF-124 - 150 mm
MF-125 - 180 mm
MF-126 - 210 mm

MF-124/MF-129

Ø 2 mm
MF-127 - 150 mm
MF-128 - 180 mm
MF-129 - 210 mm

Titan
 Titanium
 Titano
 Titane

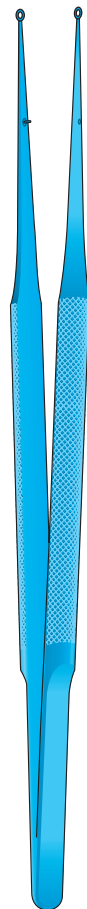

MF-142T/MF-147T

Ø 1 mm
MF-142T - 150 mm
MF-143T - 180 mm
MF-144T - 210 mm

Ø 2 mm
MF-145T - 150 mm
MF-146T - 180 mm
MF-147T - 210 mm



Titanium
 Titan
 Titane
 Titano
 Titano

Dressing Forceps

Zahnpinzetten
Cotton and Dressing Pliers
Pinzette per medicazione
Pinzas para vendajes
Précelles pour cotton

TWEEZERS

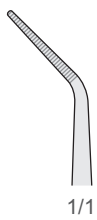

1/1

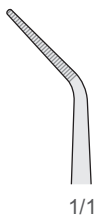

1/1



1/1

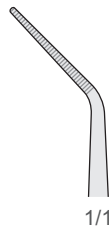

1/1

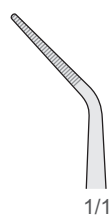

1/1



1/1



1/1



1/1

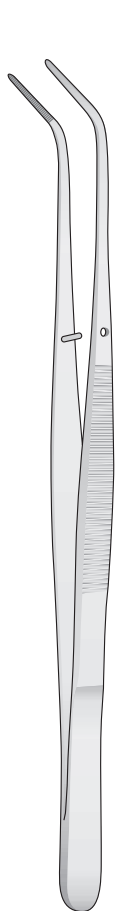

COLLEGE
150 mm

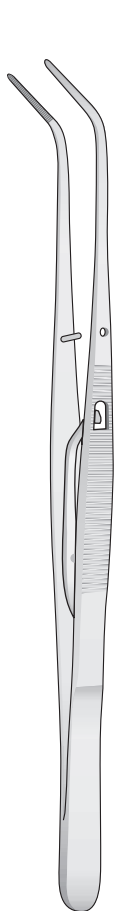

COLLEGE-S
Locking
150 mm

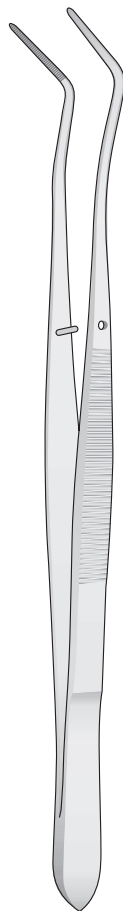

MERIAM
160 mm

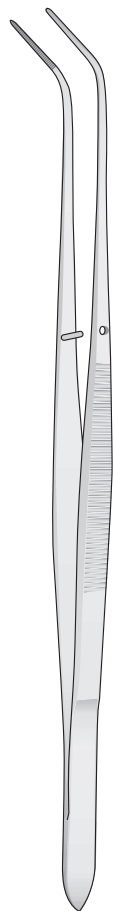

FLAGG
160 mm

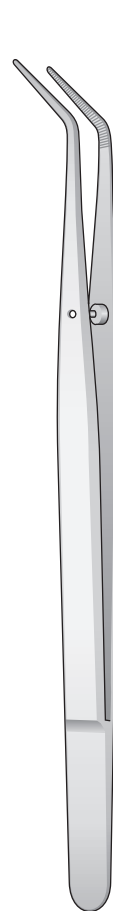

**COLLEGE
BD-01**
Fig.17
160 mm

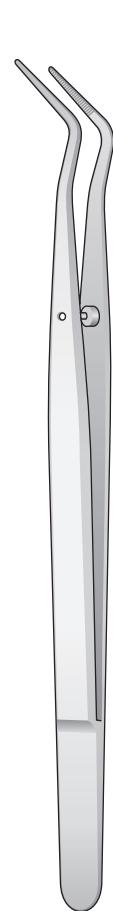

**MERIAM
BD-02**
Fig.18
150 mm



**COLLEGE
BD-03**
Fig.18L / Locking
150 mm

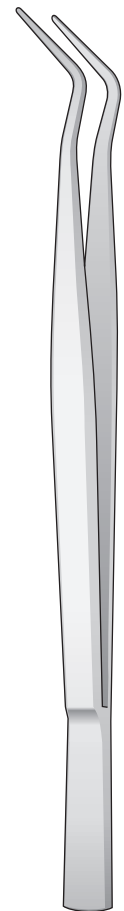

**CAULK
BD-11**
160 mm

Endo Forceps

TWEEZERS

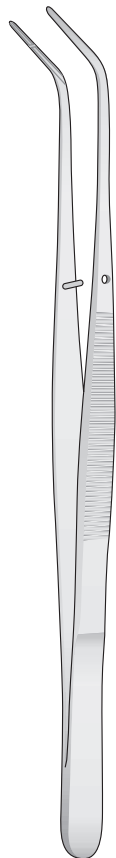
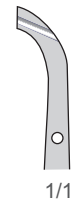
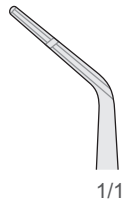
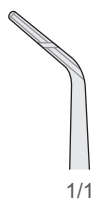
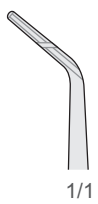

DA-04
 Endo
 150 mm

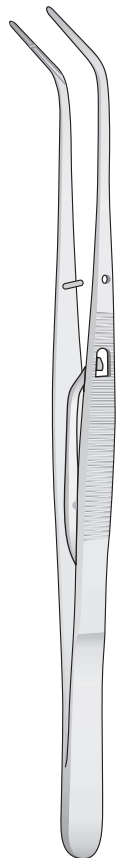

DA-05
 Endo / Locking
 150 mm



DA-09
 Endo / Locking
 150 mm



DA-11
 Endo / Locking
 155 mm

Tissue Forceps

Chirurgische und Anatomische Pinzetten
Tissue and Dressing Forceps
Pinzette anatomiche e chirurgiche
Pinzas de diseccion y chirurgicalas
Pincas anatomiques chirurgicales

TWEEZERS



DE BAKEY
BD-80/BD-165

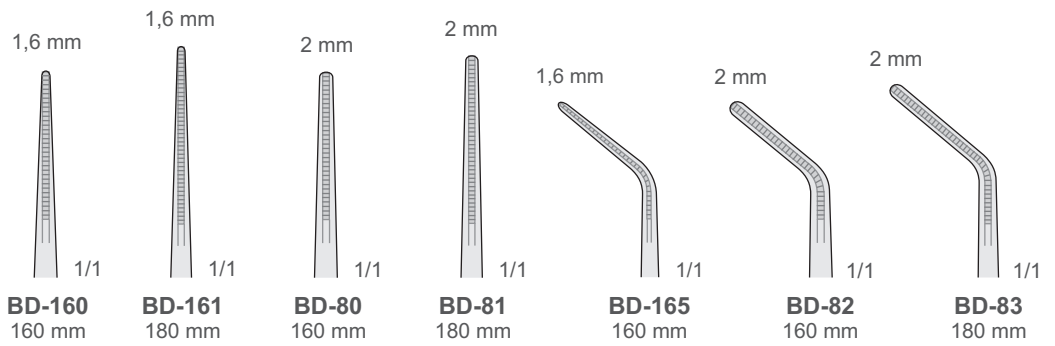

Atraumatische pinzetten
Non-traumatic forceps
Pinzette atraumatiche
Pinzas atraumaticas
Pincas atraumatiques

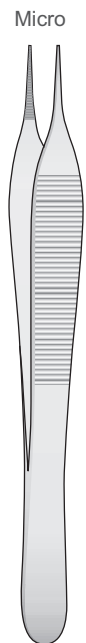

ADSON
BD-71
120 mm

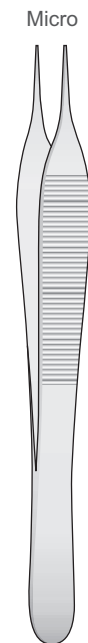
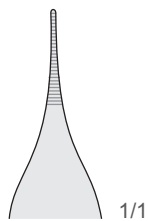

ADSON
BD-73
120 mm

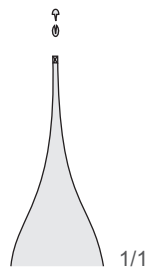

1x2 Zähne
1x2 Teeth
1x2 Denti
1x2 Dientes
1x2 Dents

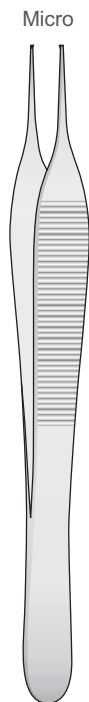

ADSON
BD-177
150 mm

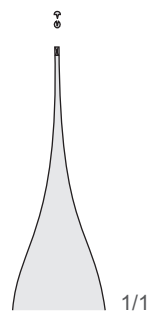

1x2 Zähne
1x2 Teeth
1x2 Denti
1x2 Dientes
1x2 Dents

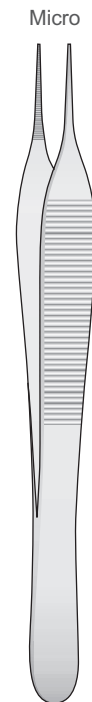

ADSON
BD-178
150 mm

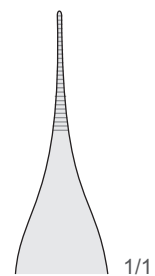

Chirurgische Pinzetten
 Tissue Forceps
 Pinzette chirurgische
 Pinzas quirúrgicas
 Pincas quirúrgicas

TWEEZERS

Taschenmarkierungspinzetten
 Pocket markers
 Pinzette segnatasche
 Pinzas para marcar el sulco periodontal
 Pincas à marquer la poche

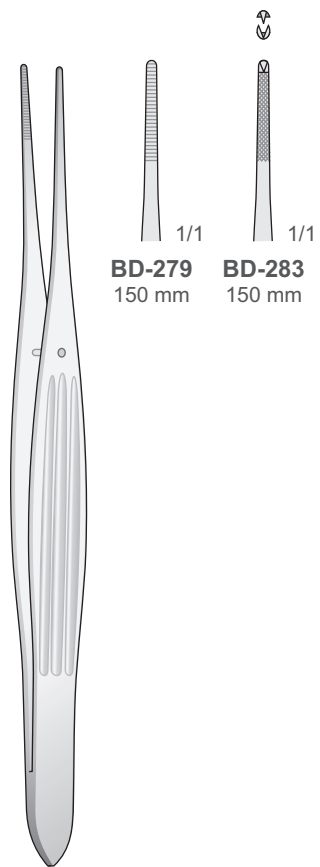

BD-279
150 mm

BD-283
150 mm

McINDOE
BD-279/BD-283
 150 mm

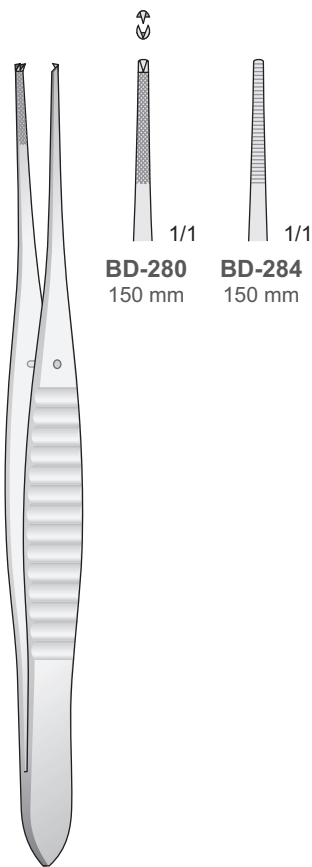

BD-280
150 mm

BD-284
150 mm

GILLIES
BD-280/BD-284
 150 mm

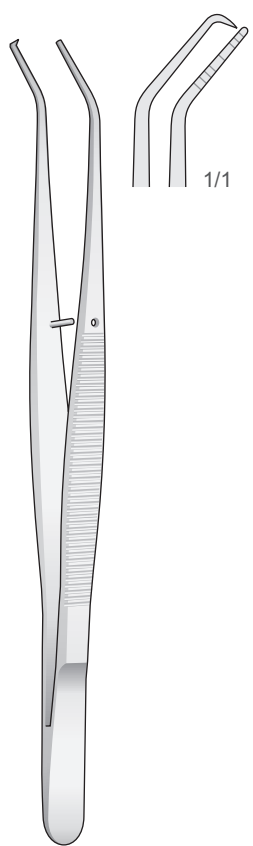

CRANE-CAPLAN
DB-01
 150 mm

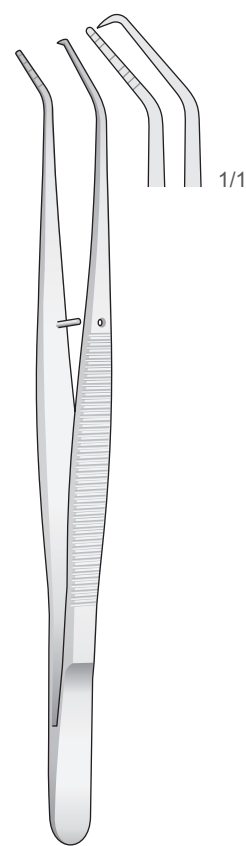

CRANE-CAPLAN
DB-02
 150 mm



GRAEFE
BD-04/BD-96
 100 mm

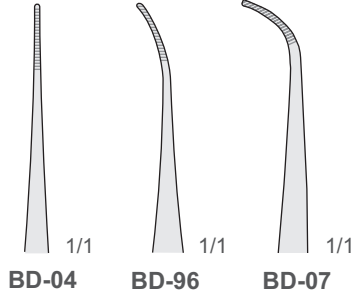

GRAEFE
BD-194/BD-196
 100 mm

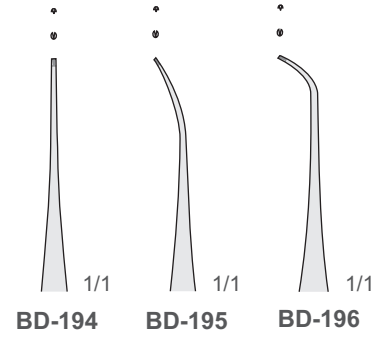

BD-32/BD-33
 100 mm

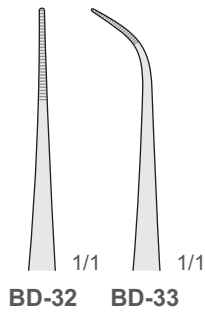

BD-35/BD-36
 100 mm

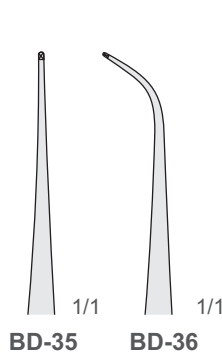

PERRY
BD-05
 125 mm

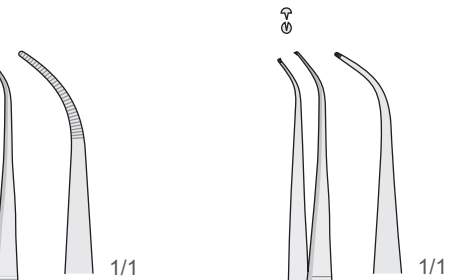

BD-06
 125 mm



Anatomische Pinzetten
 Dressing Forceps
 Pinzette anatomiche
 Pinzas de diseccion
 Pincas anatomiques

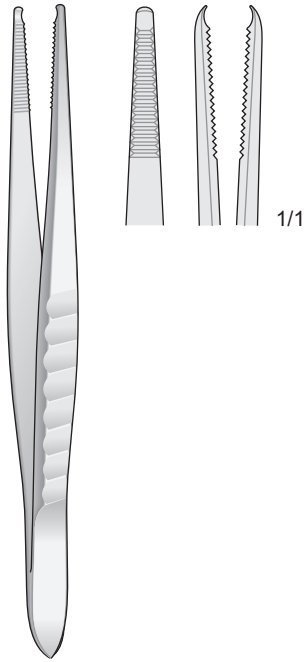

BD-270
130 mm

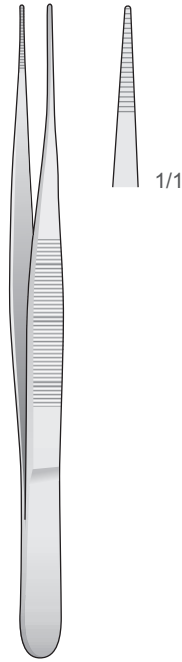

BD-145
130 mm

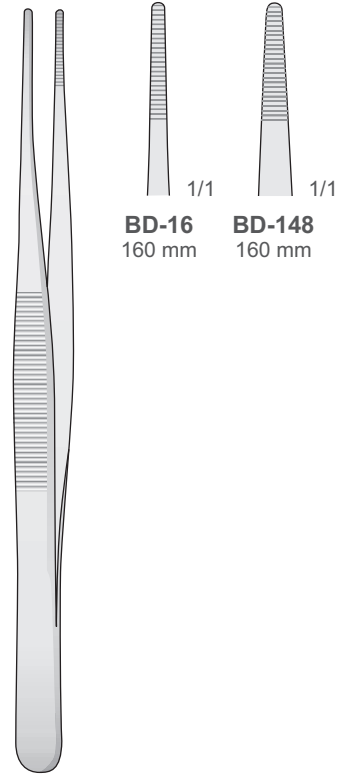

BD-16
160 mm

BD-148
160 mm



BD-10/BD-76

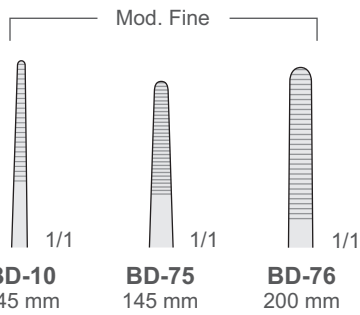

BD-97/BD-99

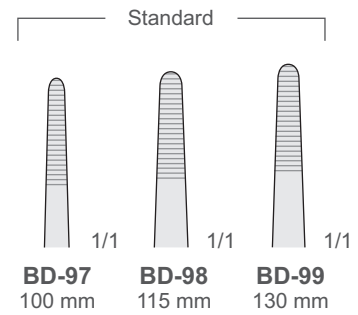

TWEEZERS

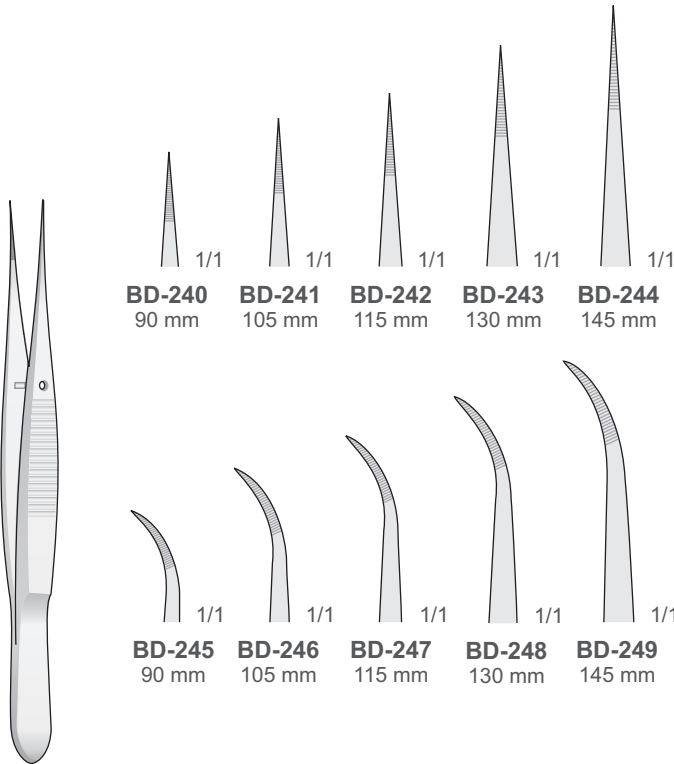

BD-240/BD-249

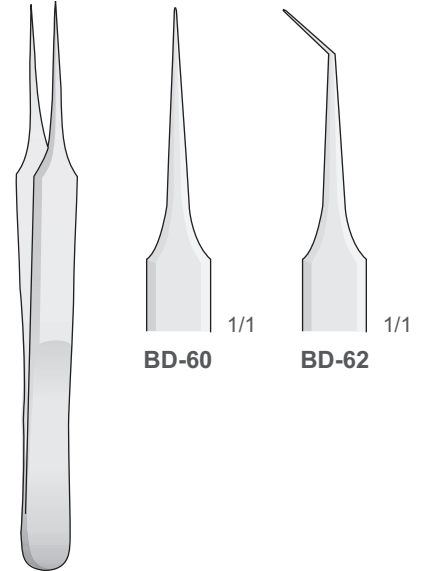

BD-60/BD-62
110 mm

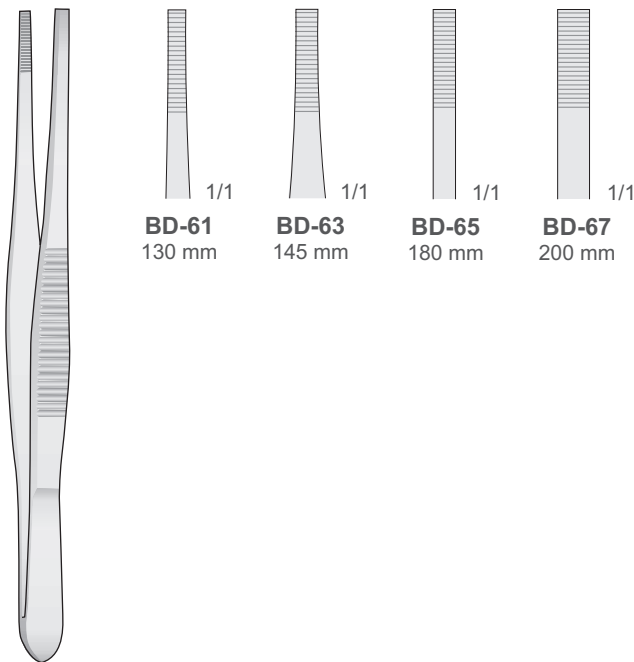

STILLE
BD-61/BD-67

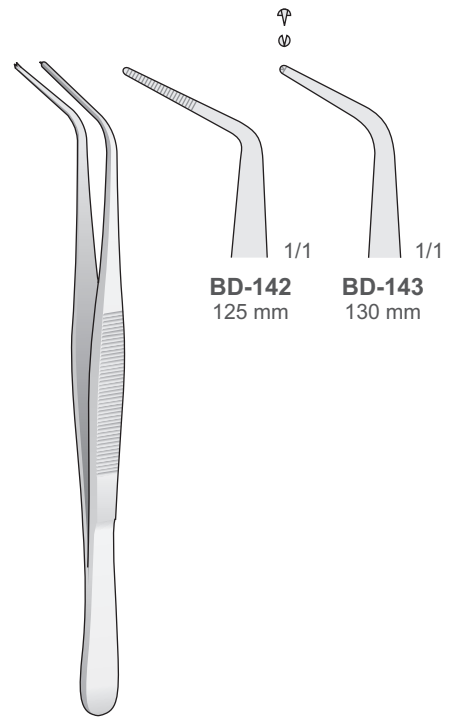

BD-142/BD-143

Chirurgische Pinzetten
 Tissue Forceps
 Pinzette chirurgische
 Pinzas quirúrgicas
 Pincas quirúrgicas

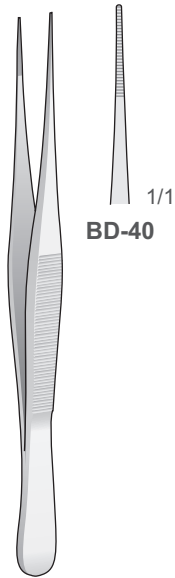

BD-40
110 mm

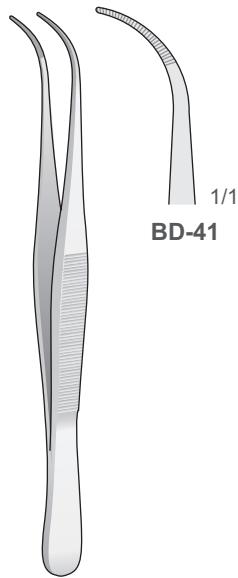

BD-41
110 mm

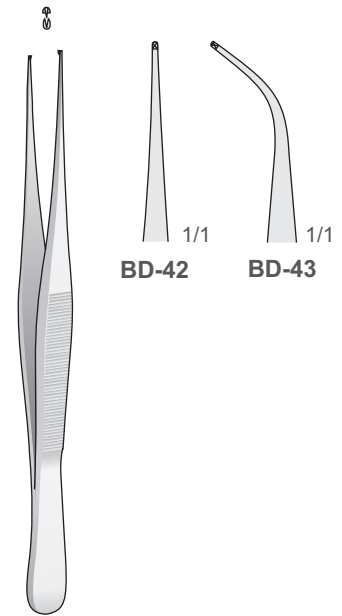

BD-42/BD-43
110 mm

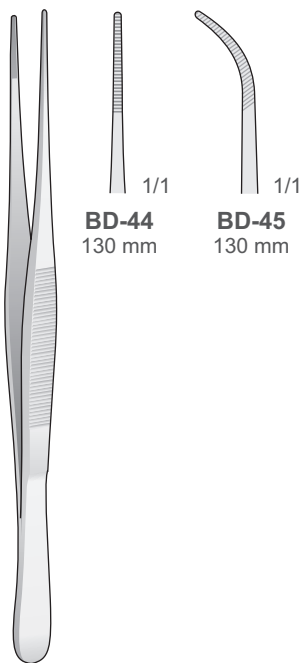

SEMKEN
BD-44/BD-45
130 mm

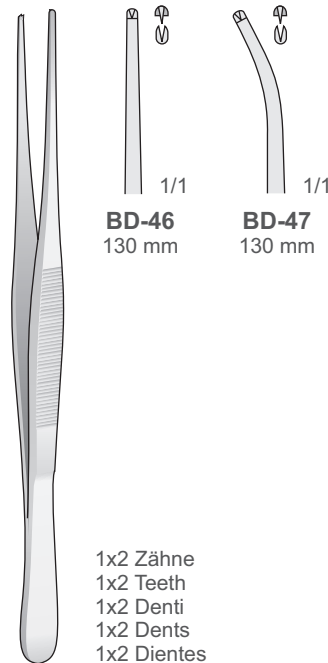

SEMKEN
BD-46/BD-47
130 mm

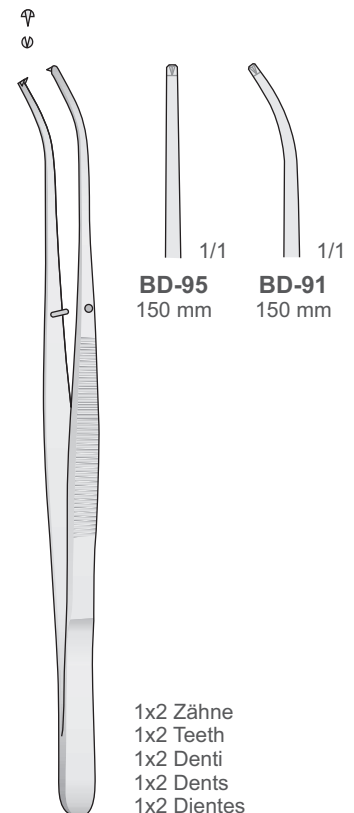

SEMKEN
BD-91/BD-95
150 mm

1x2 Zähne
 1x2 Teeth
 1x2 Denti
 1x2 Dents
 1x2 Dientes

1x2 Zähne
 1x2 Teeth
 1x2 Denti
 1x2 Dents
 1x2 Dientes

TWEEZERS

Chirurgische Pinzetten
Tissue Forceps
Pinzette chirurgische
Pinzas quirúrgicas
Pincas quirúrgicas

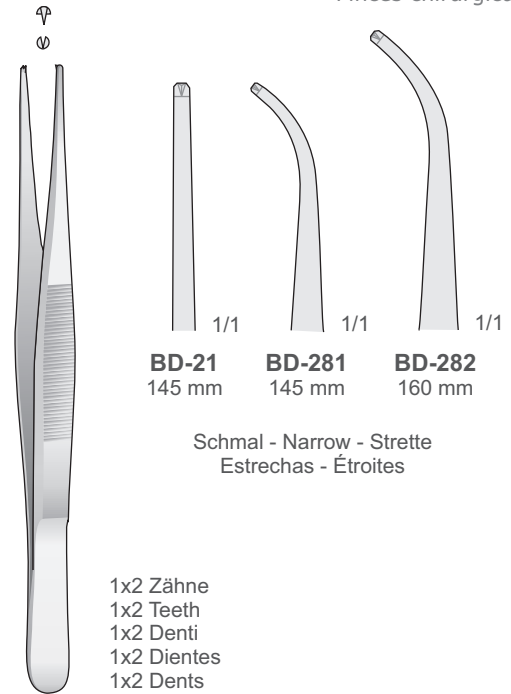
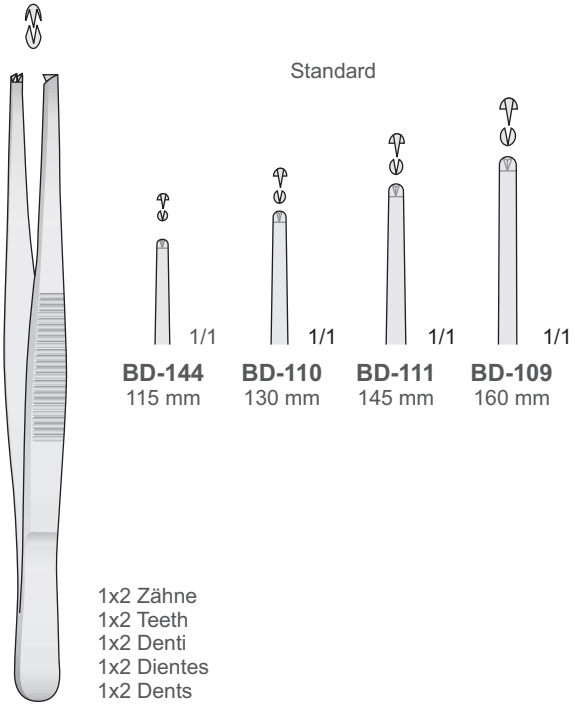

BD-109/BD-144

BD-21/BD-282

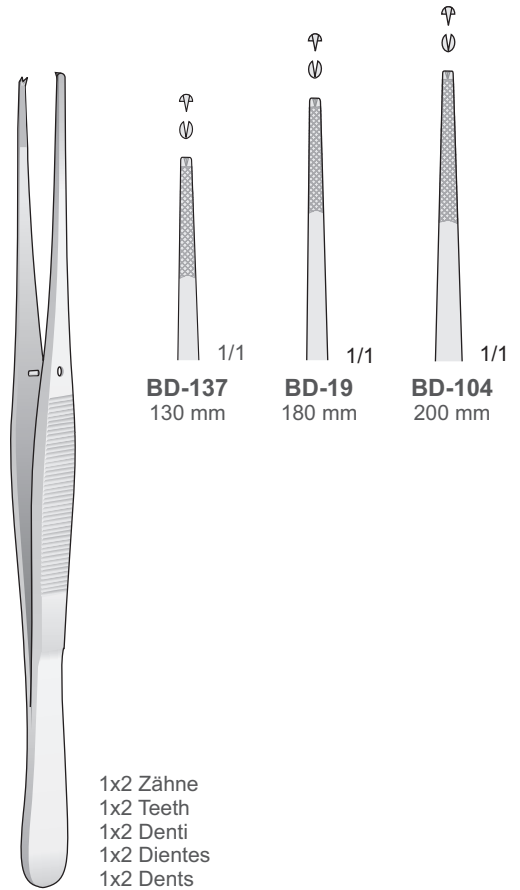
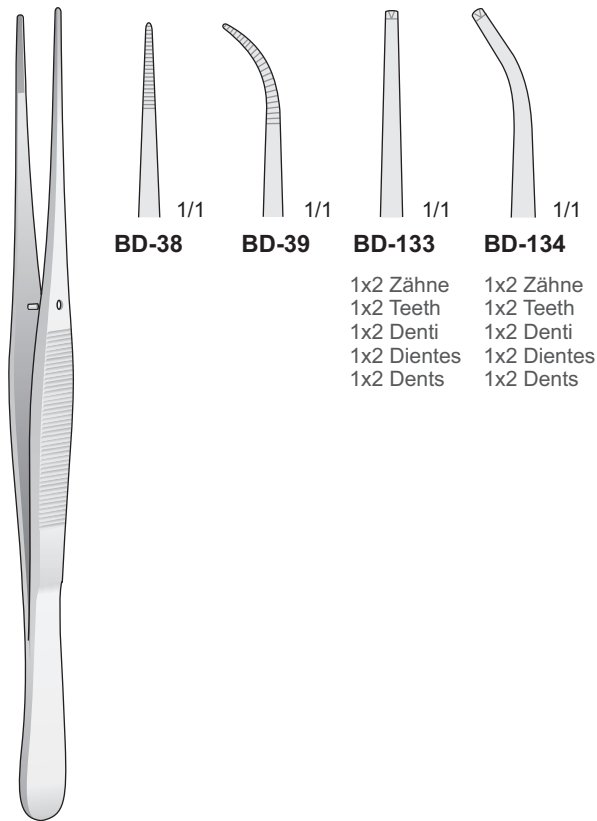

BD-38/BD-134
200 mm

BD-19/BD-137

Chirurgische Pinzetten
Tissue Forceps
Pinzette chirurgische
Pinzas quirùrgicas
Pincas quirurgicales

TWEEZERS



GERALD
MF-101
180 mm

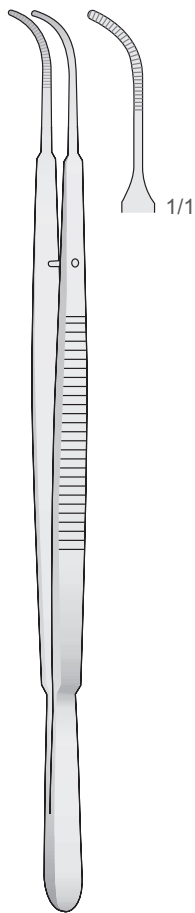

GERALD
MF-102
180 mm



GERALD
MF-103
180 mm

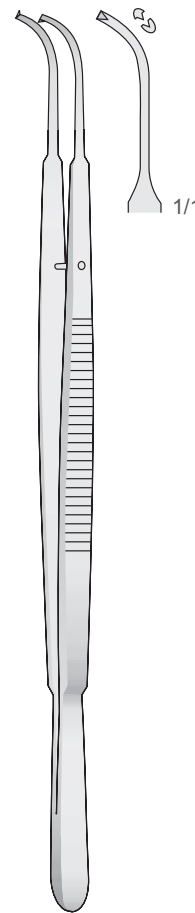

GERALD
MF-104
180 mm

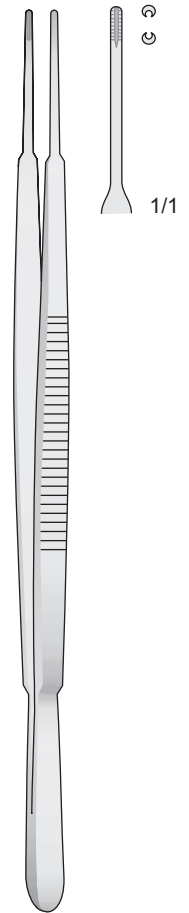

GERALD-BROWN
MF-105
180 mm

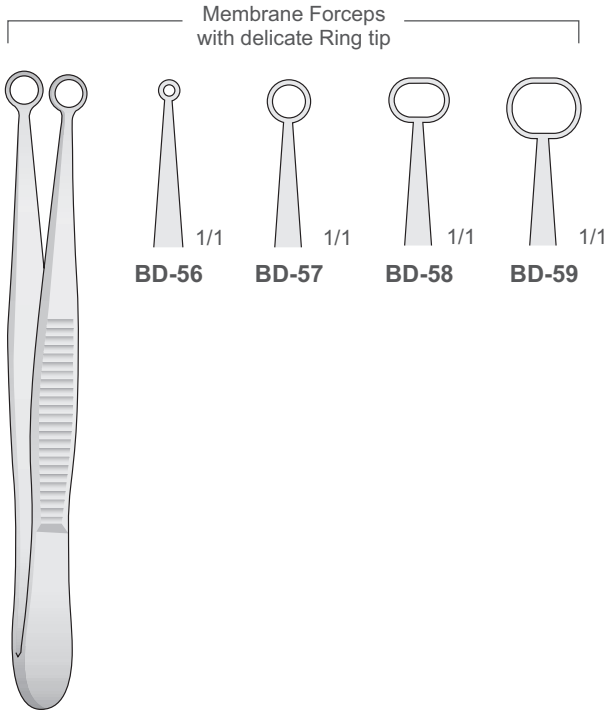

BD-56/BD-59
100 mm

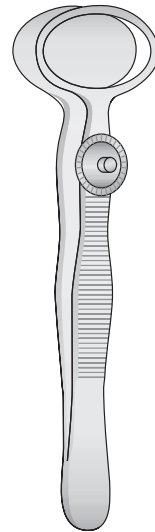

DESMARRES
BD-130/BD-131
90 mm

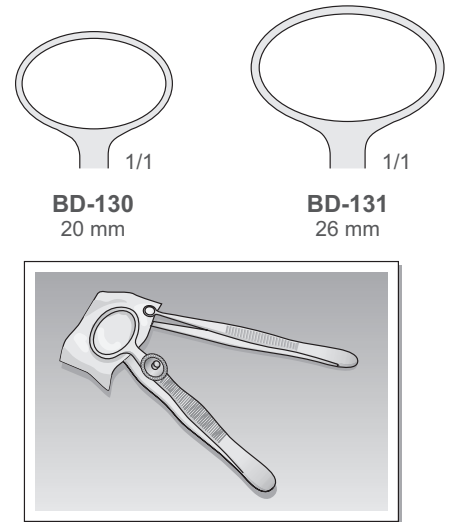

Pinzetten zum Halten Membranen
Membrane Holding forceps
Pinza per fissaggio membrane
Pinza para sostener membranas
Pince pour le maintien membranes

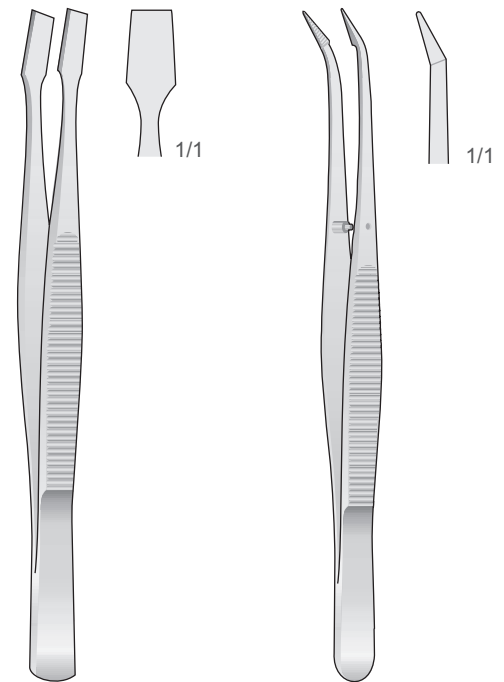
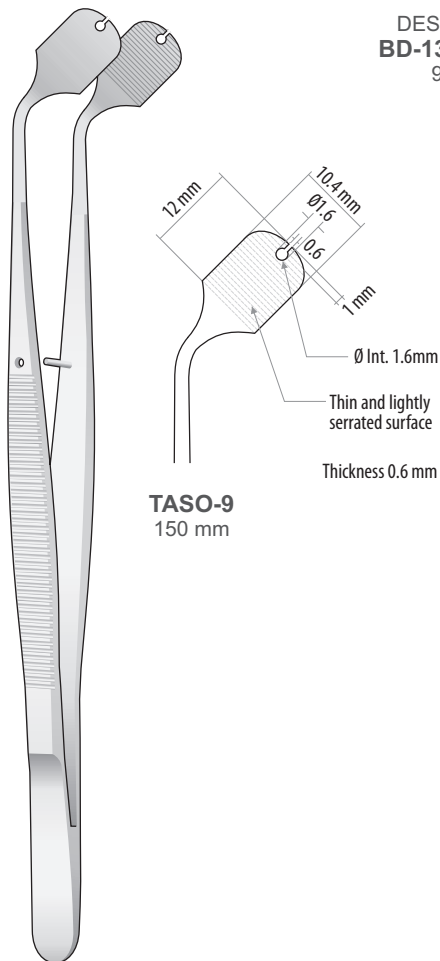

KÜHNE
ES-44
105 mm

BARRAQUER
ES-65
105 mm

TWEEZERS

Chirurgische Pinzetten
Tissue Forceps
Pinzette chirurgische
Pinzas quirúrgicas
Pincas quirúrgicas

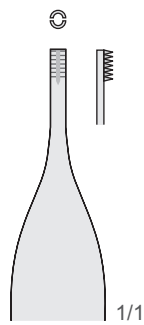
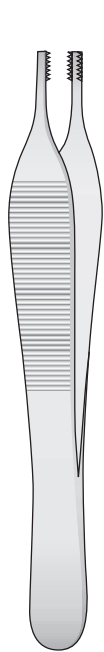

BD-92
120 mm

6x6 Zähne
6x6 Teeth
6x6 Denti
6x6 Dientes
6x6 Dents

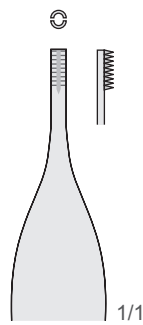

BD-141
120 mm

9x9 Zähne
9x9 Teeth
9x9 Denti
9x9 Dientes
9x9 Dents

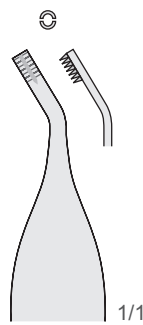

BD-93
120 mm

6x6 Zähne
6x6 Teeth
6x6 Denti
6x6 Dientes
6x6 Dents

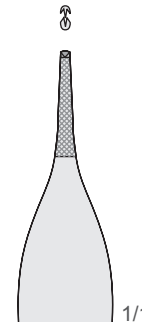
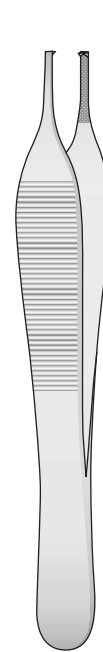

BD-90
120 mm

ADSON-BROWN
BD-92/BD-141
120 mm

ADSON
BD-90
120 mm

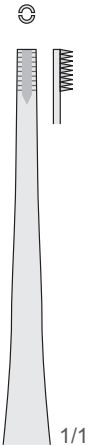

8x8 Zähne
8x8 Teeth
8x8 Denti
8x8 Dientes
8x8 Dents

BROWN
BD-94
150 mm

Standard

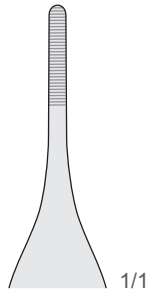

ADSON
BD-380
150 mm

Standard

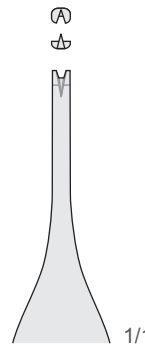

1x2 Zähne
1x2 Teeth
1x2 Denti
1x2 Dientes
1x2 Dents

ADSON
BD-381
150 mm

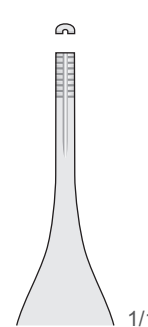

9x9 Zähne
9x9 Teeth
9x9 Denti
9x9 Dientes
9x9 Dents

ADSON-BROWN
BD-382
150 mm

TWEEZERS

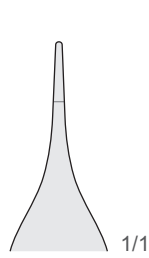

Mit Fadenplatte
 With tying platform
 Con piano prendifilo
 Con plataforma
 Avec plateau pour monofil

ADSON
BD-370
 120 mm

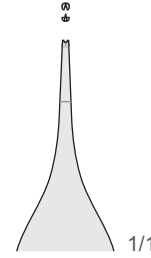

Mit Fadenplatte
 With tying platform
 Con piano prendifilo
 Con plataforma
 Avec plateau pour monofil
 1x2 Zähne
 1x2 Teeth
 1x2 Denti
 1x2 Dientes
 1x2 Dents

ADSON
BD-371
 120 mm

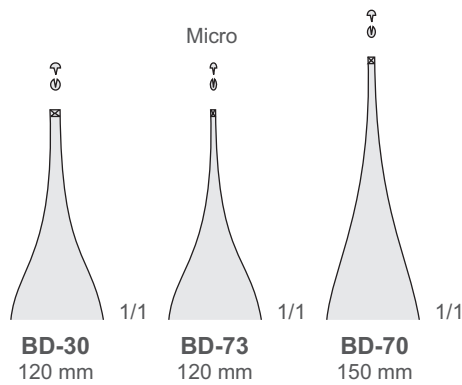
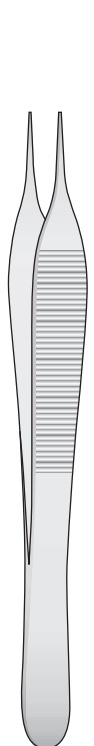

ADSON
BD-30/BD-73

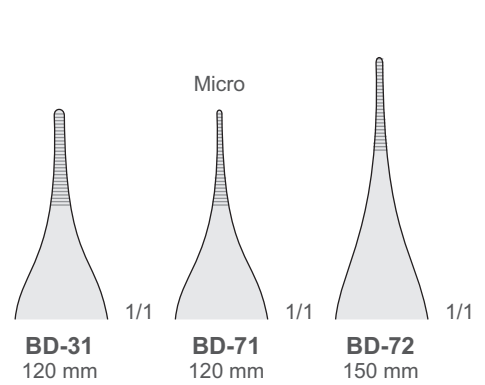
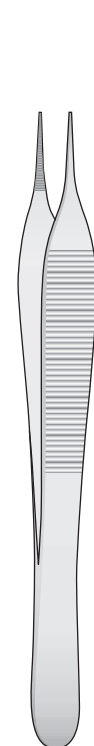

ADSON
BD-31/BD-72

Chirurgische Pinzetten - Anatomische Pinzetten
 Tissue Forceps - Dressing forceps
 Pinzette chirurgische - Pinzette anatomiche
 Pinzas quirùrgicas - Pinzas de diseccion
 Pincas quirurgicales - Pincas anatomiques

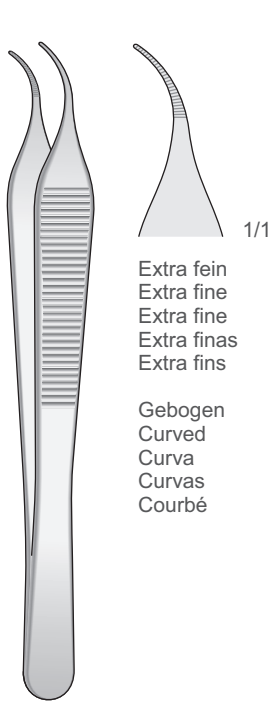

Extra fein
 Extra fine
 Extra fine
 Extra finas
 Extra fins

Gebogen
 Curved
 Curva
 Curvas
 Courbé

MICRO-ADSON
BD-372
 120 mm

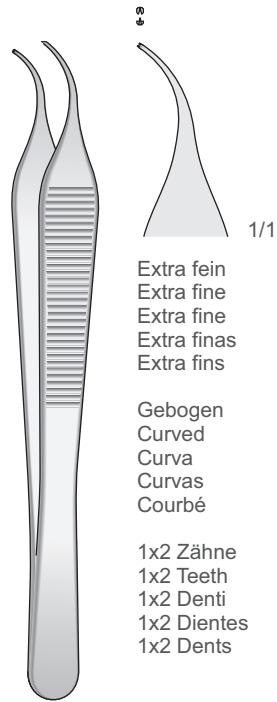

Extra fein
 Extra fine
 Extra fine
 Extra finas
 Extra fins

Gebogen
 Curved
 Curva
 Curvas
 Courbé

1x2 Zähne
 1x2 Teeth
 1x2 Denti
 1x2 Dientes
 1x2 Dents

MICRO-ADSON
BD-373
 120 mm

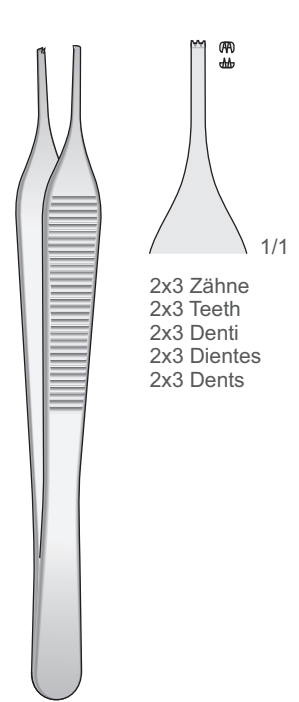

2x3 Zähne
 2x3 Teeth
 2x3 Denti
 2x3 Dientes
 2x3 Dents

ADSON
BD-377
 120 mm

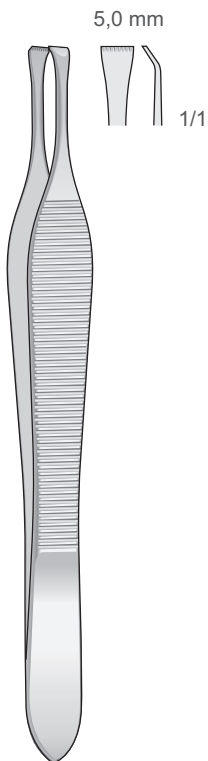

BEASLEY-BABCOCK
BD-51
 120 mm

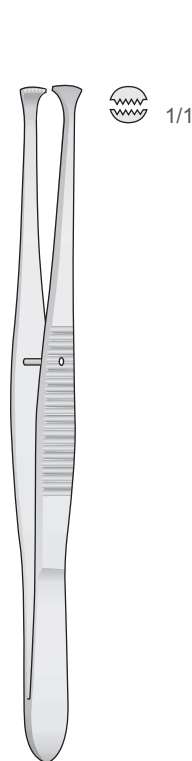

GRAEFE
BD-135
 110 mm

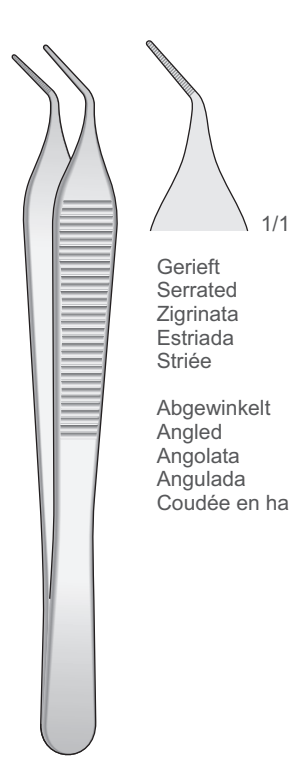

Gerieft
 Serrated
 Zigrinata
 Estriada
 Striée

Abgewinkelt
 Angled
 Angolata
 Angulada
 Coudée en haut

ADSON
BD-378
 120 mm

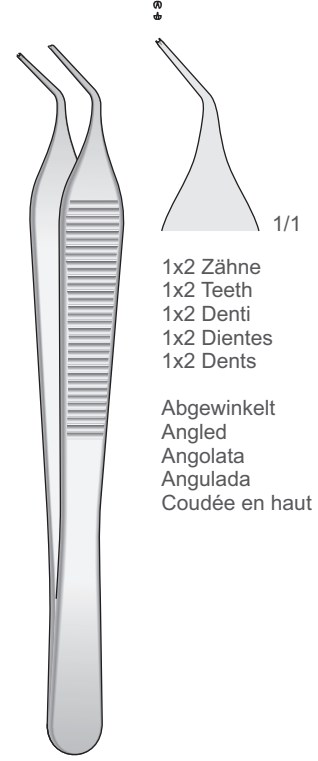

1x2 Zähne
 1x2 Teeth
 1x2 Denti
 1x2 Dientes
 1x2 Dents

Abgewinkelt
 Angled
 Angolata
 Angulada
 Coudée en haut

ADSON
BD-379
 120 mm

TWEEZERS

Chirurgische Pinzetten - Anatomische Pinzetten
 Tissue Forceps - Dressing forceps
 Pinzette chirurgische - Pinzette anatomische
 Pinzas quirúrgicas - Pinzas de disección
 Pincas quirúrgicas - Pincas anatómicas



BD-09/BD-20

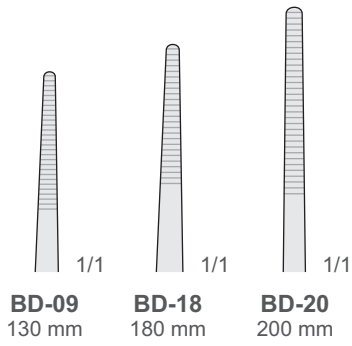

BD-23/BD-26

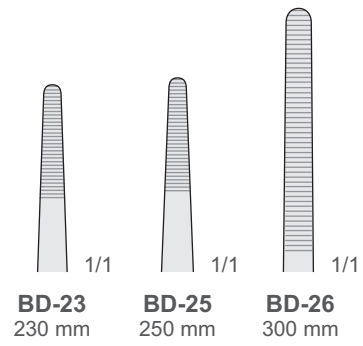

BD-271/BD-276

1x2 Zähne
 1x2 Teeth
 1x2 Denti
 1x2 Dientes
 1x2 Dents

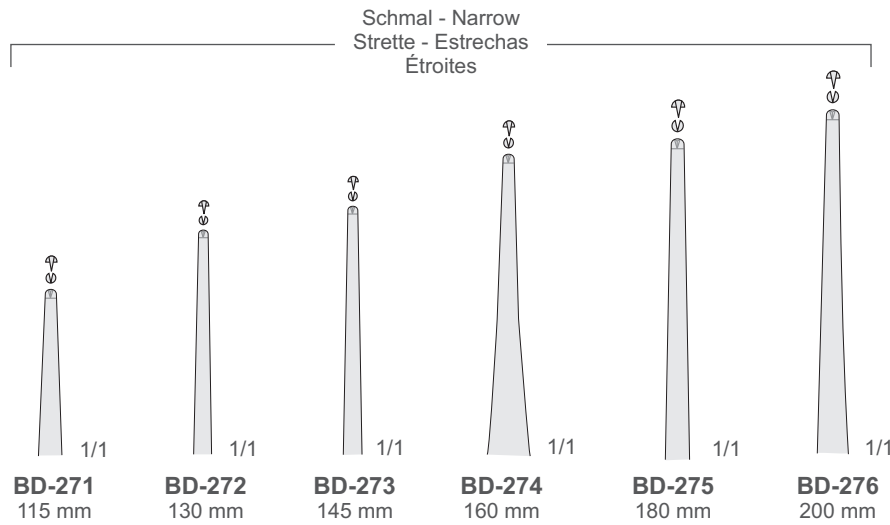

Chirurgische Pinzetten
 Tissue Forceps
 Pinzette chirurgische
 Pinzas quirúrgicas
 Pincas quirúrgicas

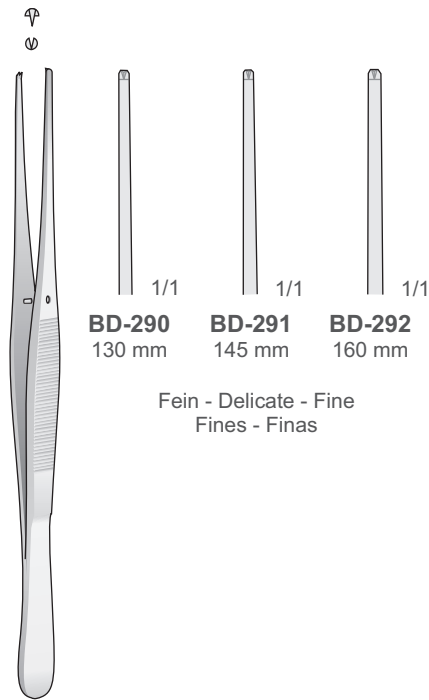

BD-290 130 mm
BD-291 145 mm
BD-292 160 mm

Fein - Delicate - Fine
 Fines - Finas

BD-290/BD-292

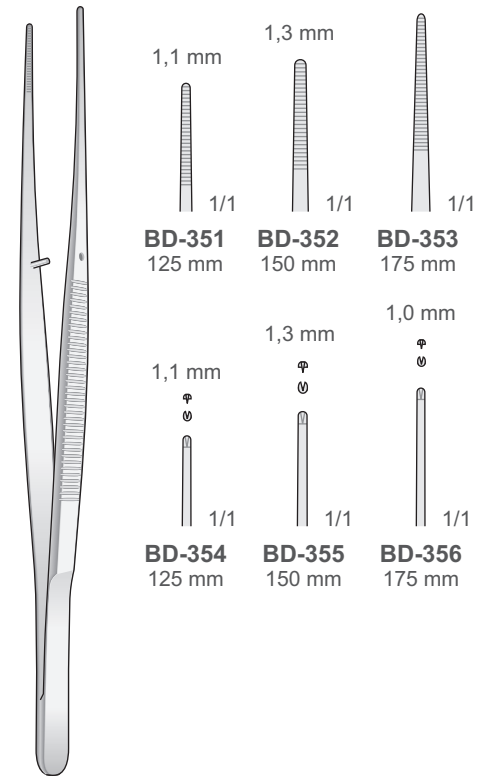

BD-351 125 mm
BD-352 150 mm
BD-353 175 mm

BD-354 125 mm
BD-355 150 mm
BD-356 175 mm

BD-351/BD-356

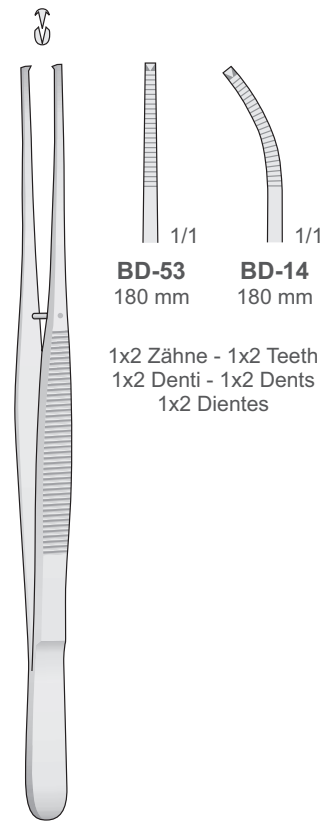

BD-53 180 mm
BD-14 180 mm

1x2 Zähne - 1x2 Teeth
 1x2 Denti - 1x2 Dents
 1x2 Dientes

POTTS-SMITH
BD-14/BD-53
 180 mm

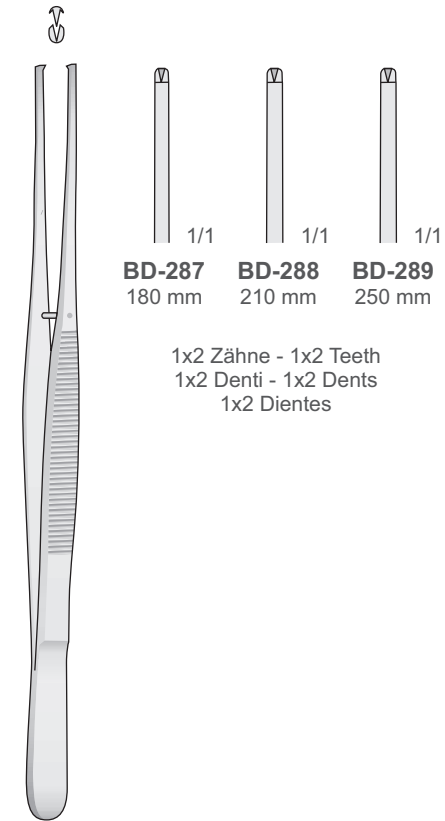

BD-287 180 mm
BD-288 210 mm
BD-289 250 mm

1x2 Zähne - 1x2 Teeth
 1x2 Denti - 1x2 Dents
 1x2 Dientes

POTTS-SMITH
BD-287/BD-289

TWEEZERS

TC Forceps / Atraumatic

Chirurgische Pinzetten, Atraumatische Pinzetten
 Tissue Forceps, Non-traumatic Forceps
 Pinzette chirurgische, Pinzette atraumatiche
 Pinzas quirurgicas, Pinzas atraumaticas
 Pincas chirurgicales, Pincas atraumaticas

TWEEZERS

TC



MF-106
175 mm

MF-107
175 mm

1x2 Zähne
 1x2 Teeth
 1x2 Denti
 1x2 Dientes
 1x2 Griffes

GERALD
MF-106/MF-107
 175 mm



Tungsten-Carbide Inserts
 Mit Hartmetalleinsätzen
 Plaquettes en carbure de tungstène
 Plaquetas de carburo de tungsteno
 Inserti in carburo di tungsteno

TC

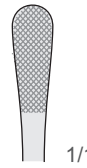

WANGENSTEEN
BD-232
 150 mm

TC

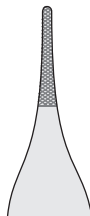
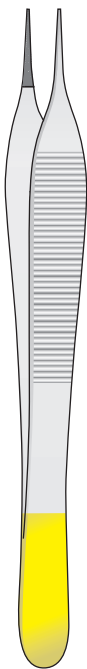

BD-230
120 mm

1/1

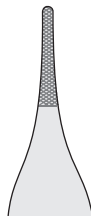

BD-231
150 mm

1/1

ADSON
BD-230/BD-231

TC

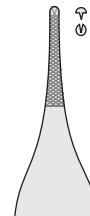
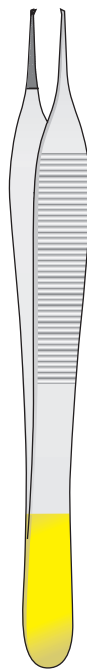

BD-250
120 mm

1/1

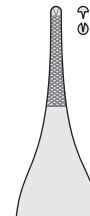

BD-251
150 mm

1/1

1x2 Zähne
 1x2 Teeth
 1x2 Denti
 1x2 Dientes
 1x2 Griffes

1x2 Zähne
 1x2 Teeth
 1x2 Denti
 1x2 Dientes
 1x2 Griffes

ADSON
BD-250/BD-251

Chirurgische Pinzetten, Atraumatische Pinzetten
 Tissue Forceps, Non-traumatic Forceps
 Pinzette chirurgische, Pinzette atraumatiche
 Pinzas quirùrgicas, Pinzas atraumáticas
 Pincas quirurgicales, Pincas atraumatiques



BD-210/BD-213

Standard

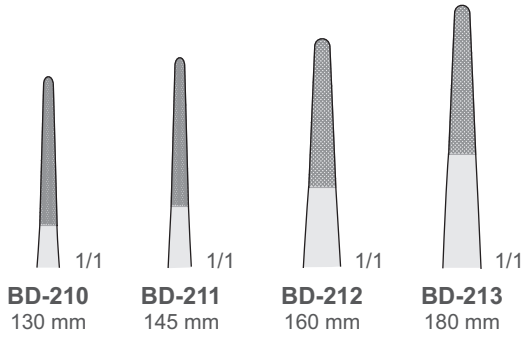

SEMKEN
 BD-216/BD-217

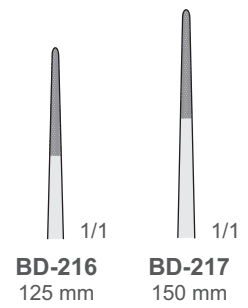

TC
TUNGSTEN CARBIDE

Tungsten-Carbide Inserts
 Mit Hartmetalleinsätzen
 Plaquettes en carbure de tungstène
 Plaquetas de carburo de tungsteno
 Inserti in carburo di tungsteno



BD-221/BD-224

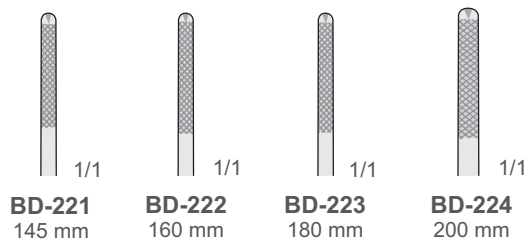

DE BAKERY
 BD-267
 160 mm



TWEEZERS

Membrane

Naht-und Membranpinzette - Suture and membrane Forceps
 Pinzette per suture e membrane - Pinzas para suturas y membranas
 Pincettes à suture et à membrane

Pinzetten
 Forceps
 Pinzette
 Pinzas
 Pincés

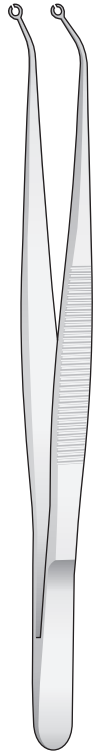

Ø Int 1.6 mm
 1/1
BD-158
 Ø Int 2.2 mm
 1/1
BD-159

BD-158/BD-159
 160 mm

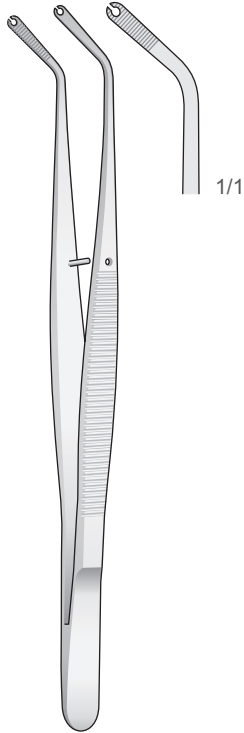

CORN DA-07
 150 mm

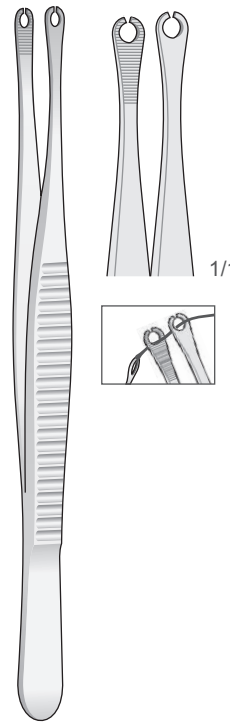

DA-06
 150 mm

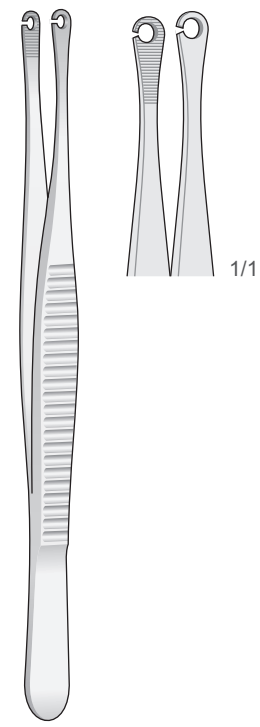

DA-08
 150 mm

TWEEZERS

Artikulationspapier-Pinzetten - Articulating Paper Forceps
 Pinza per carta articolazione - Pinzas para papel de articular
 Pince pour papier à articuler

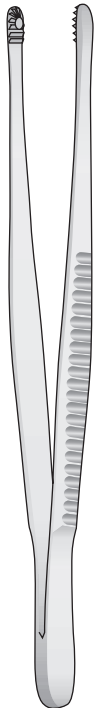

RUSSIAN BD-27/BD-175

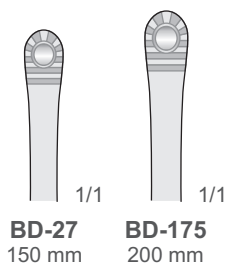

BD-27
 150 mm

BD-175
 200 mm

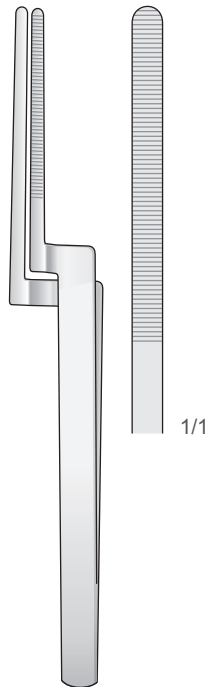

MILLER DR-78
 145 mm

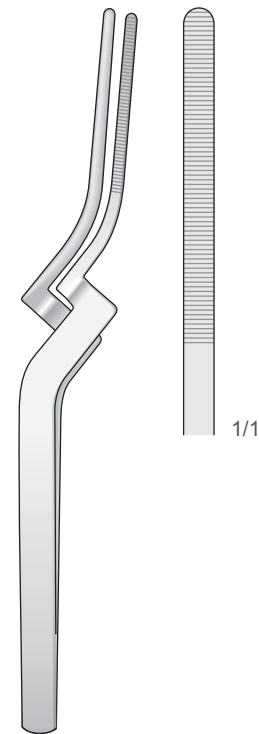

MILLER DR-80
 160 mm

• Drivers

141 | Needle Holders



NEEDLE
HOLDERS

Nadelhalter
 Needle Holders
 Port'aghi
 Portaagujas
 Porte aiguilles

Needle Holders

Mit Scheren
 With Scissor
 Con forbice
 Con tijeras
 Avec ciseaux

Glattes Maul
 Smooth Jaw
 Morso liscio
 Mandíbula lisa
 Mors lisse

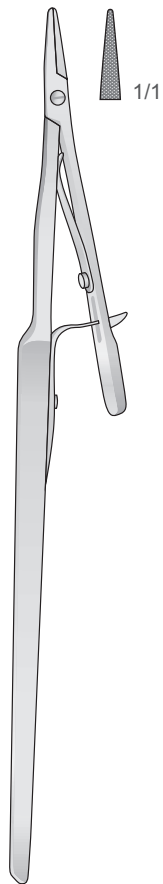

STEVENS
FD-38
 160 mm

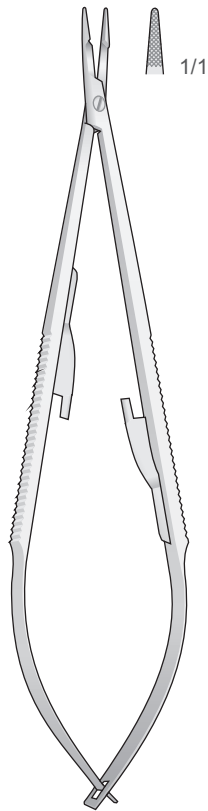

FD-26
 140 mm

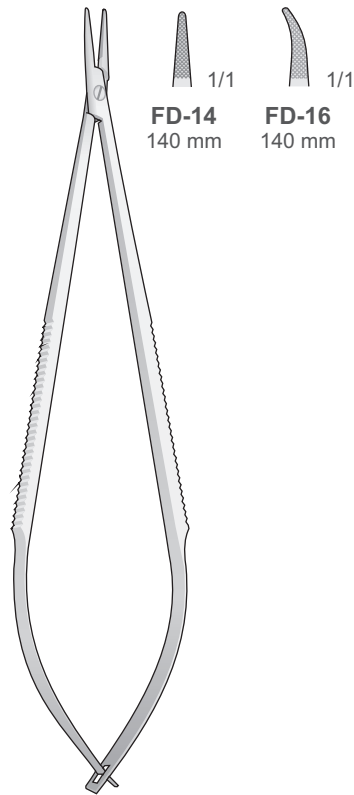

FD-14/FD-16
 140 mm

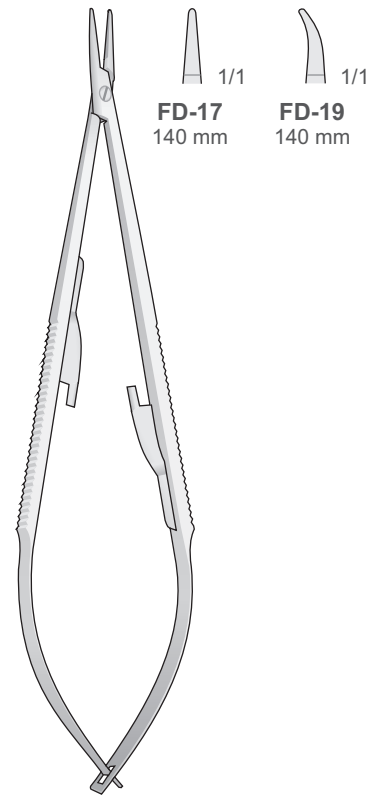

CASTROVIEJO
FD-17/FD-19
 140 mm

DRIVERS

Mit Locking-System
With Locking System (stop)
Con sistema di bloccaggio
Con sistema de bloqueo
Avec système de verrouillage

Glattes Maul
Smooth Jaw
Morso liscio
Mandíbula lisa
Mors lisse

Feingerieftes Maul
Fine serrated jaws
Morso zigrinato fine
Mandíbula estriada fina
Mors strié fin

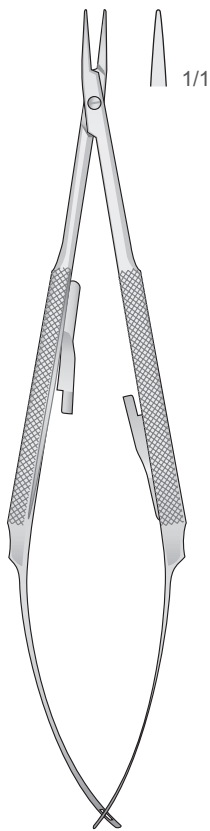

BARRAQUER
FD-216
150 mm

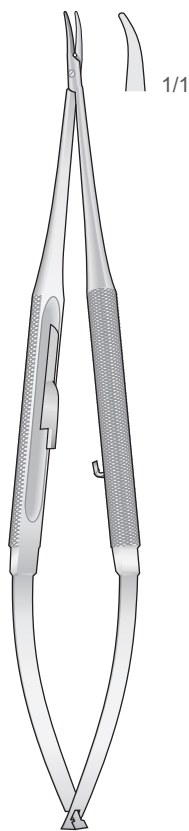

BARRAQUER
FD-217
150 mm

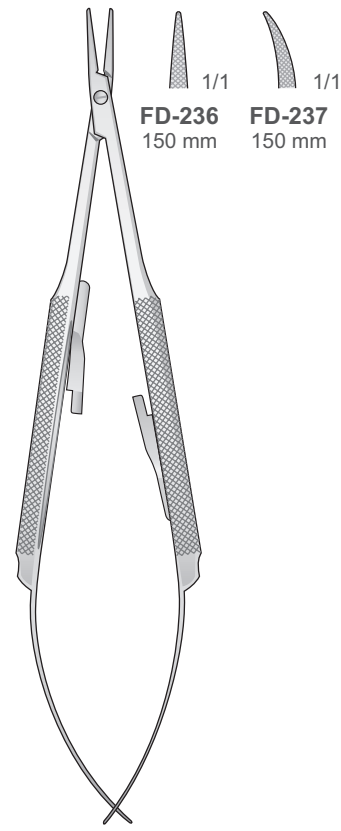

BARRAQUER
FD-236/FD-237
150 mm

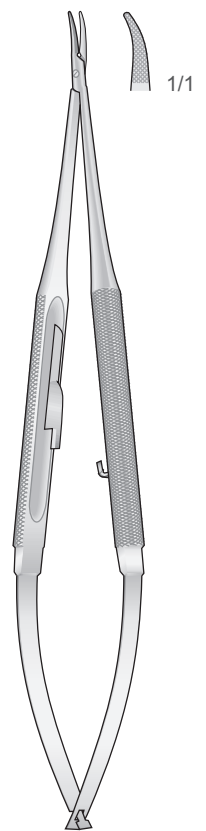

BARRAQUER
FD-24
150 mm

Nadelhalter
 Needle Holders
 Port'aghi
 Portaagujas
 Porte aiguilles



Tungsten-Carbide Inserts
 Mit Hartmetalleinsätzen
 Plaquettes en carbure de tungstène
 Plaquetas de carburo de tungsteno
 Inserti in carburo di tungsteno

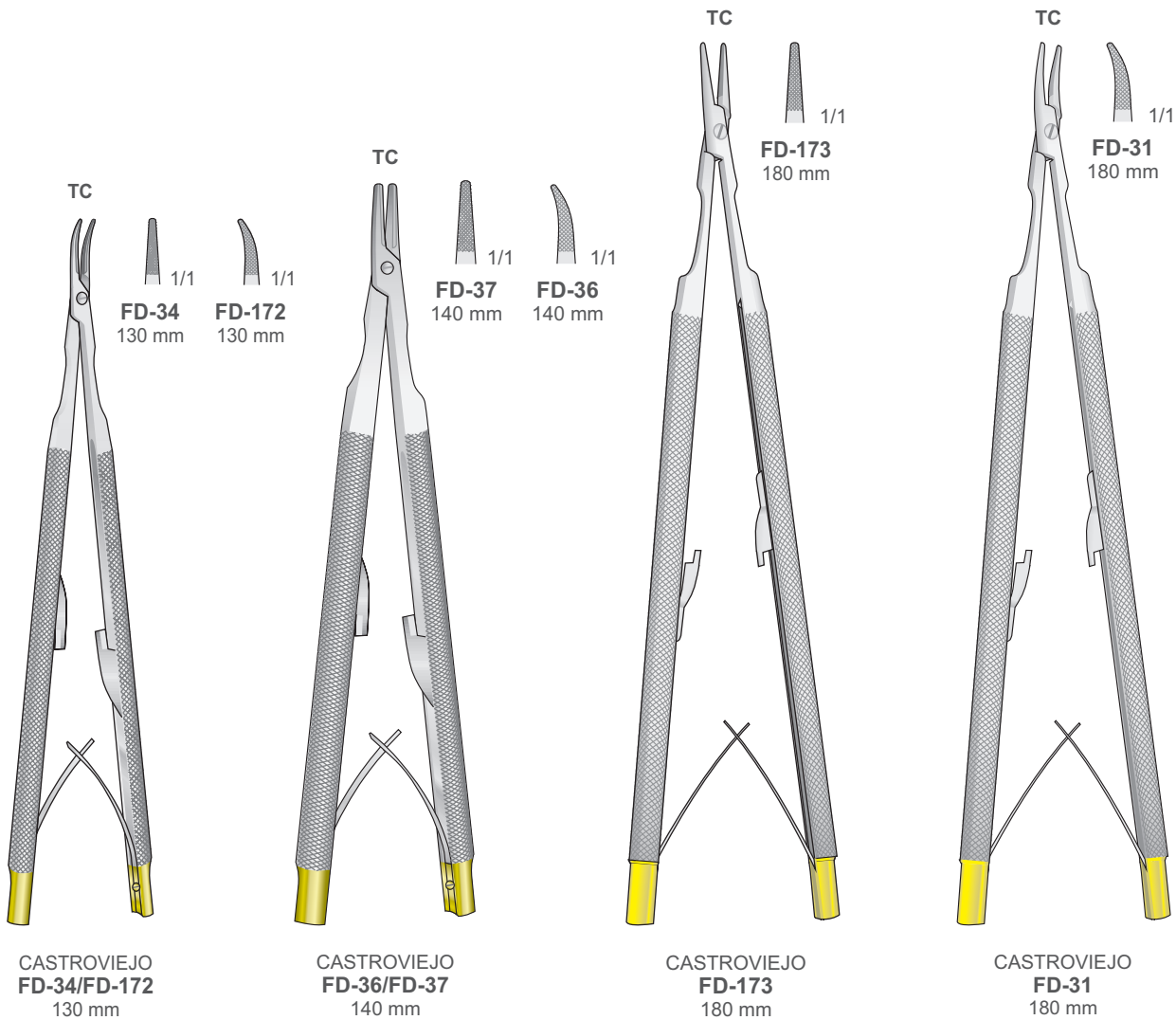

DRIVERS



Tungsten-Carbide Inserts
 Mit Hartmetalleinsätzen
 Plaquettes en carbure de tungstène
 Plaquetas de carburo de tungsteno
 Inserti in carburo di tungsteno

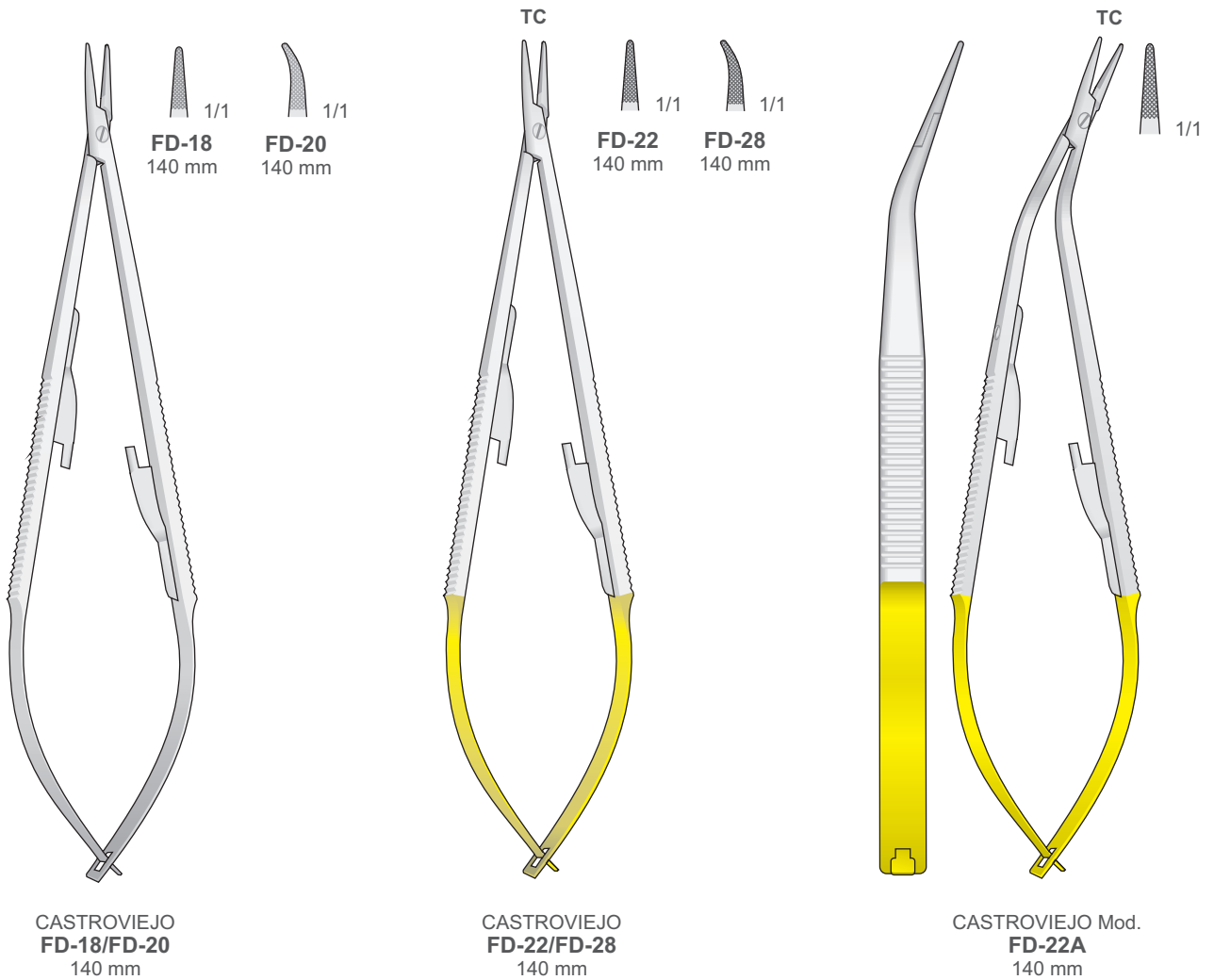

Nadelhalter
 Needle Holders
 Port'aghi
 Portaagujas
 Porte aiguilles



Tungsten-Carbide Inserts
 Mit Hartmetalleinsätzen
 Plaquettes en carbure de tungstène
 Plaquetas de carburo de tungsteno
 Inserti in carburo di tungsteno

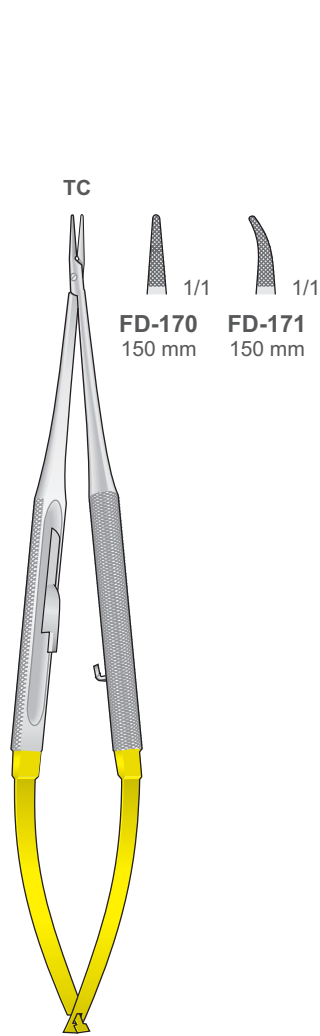

JACOBSON
 FD-170/FD-171
 150 mm

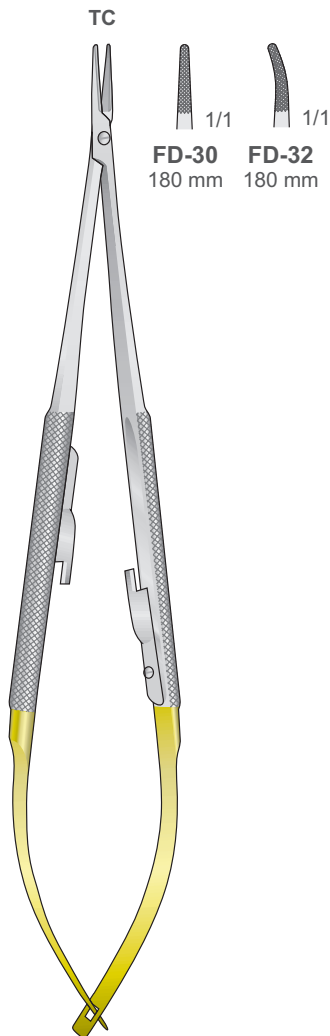

JACOBSON
 FD-30/FD-32
 180 mm

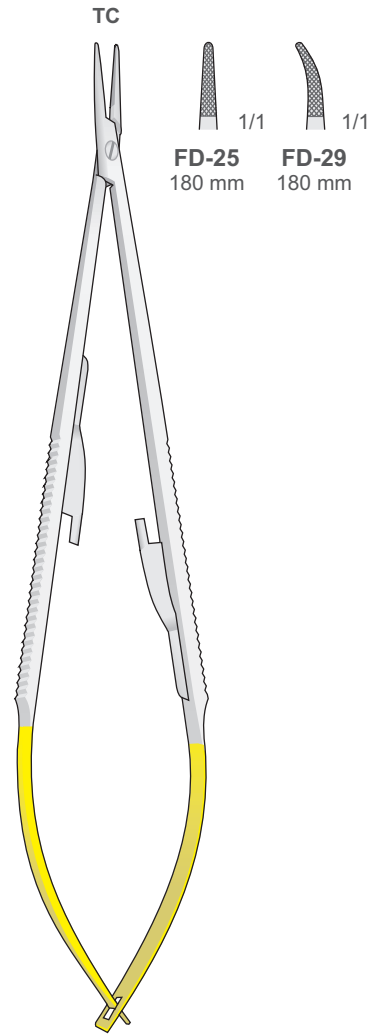

CASTROVIEJO
 FD-25/FD-29
 180 mm

DRIVERS



Tungsten-Carbide Inserts
Mit Hartmetalleinsätzen
Plaquettes en carbure de tungstène
Plaquetas de carburo de tungsteno
Inserti in carburo di tungsteno

Glattes Maul
Smooth jaws
Con morso liscio
Mandibula lisa
A' mors lisse

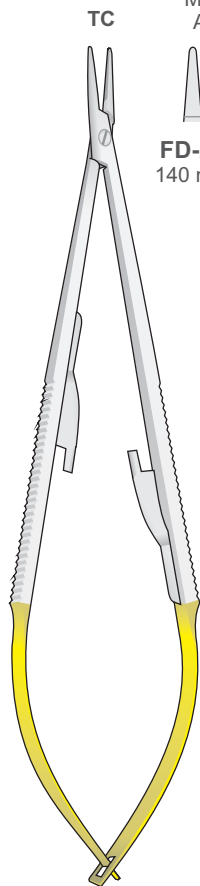

CASTROVIEJO
FD-21/FD-23
140 mm

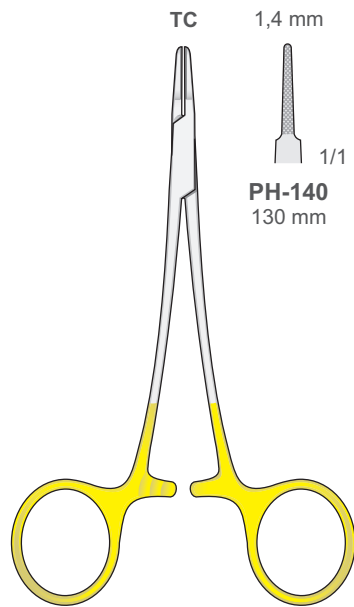
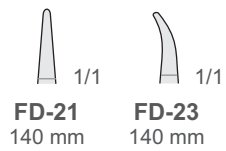

MICRO-RYDER
PH-140/PH-142

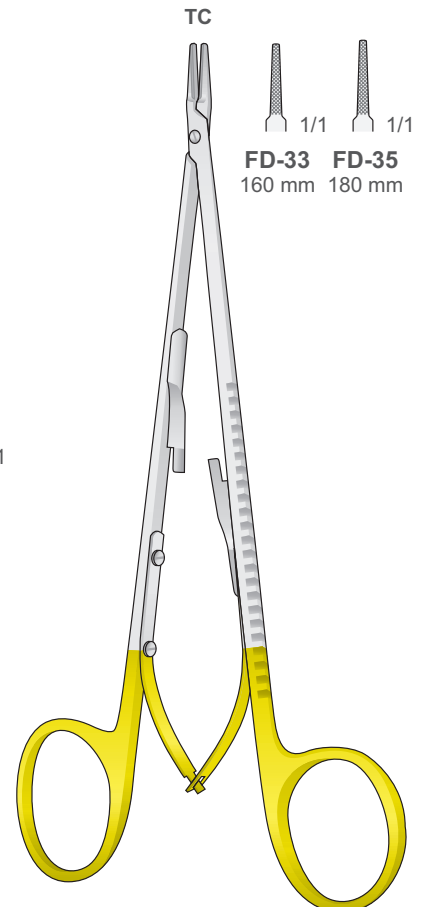
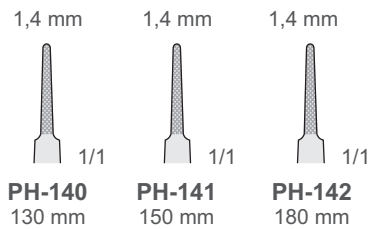

DIETRICH
FD-33/FD-35

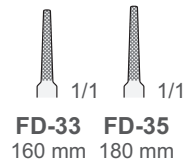

Mikro Nadelhalter - Mikro Scheren
 Micro Needle Holders - Micro Scissors
 Micro Port'aghi - Micro Forbici
 Micro Portaagujas - Micro Tijeras
 Micro Porte aiguilles - Micro Ciseaux



Rund-Griffe Ø 8 mm
 Round handle Ø 8 mm
 Manico rotondo Ø 8 mm
 Mango redondo Ø 8 mm
 Manche rond Ø 8 mm

Mikro Nadelhalter
 Micro Needle Holders
 Micro port'aghi
 Micro portaagujas
 Micro porte aiguilles

Mikro Scheren
 Micro Scissors
 Micro forbici
 Micro tijeras
 Micro ciseaux

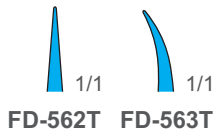
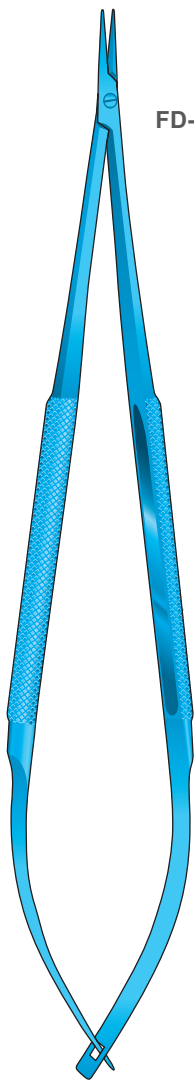

FD-562T/FD-563T
180 mm

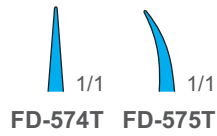
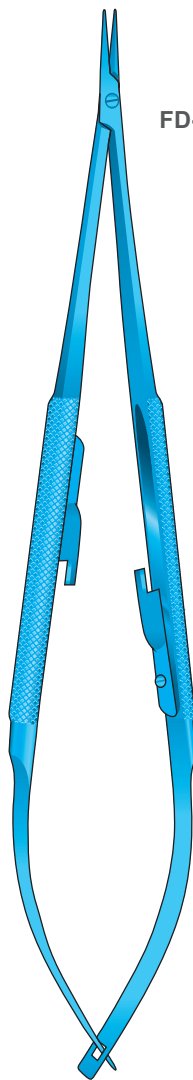

Mit Sperre
 With Lock
 Con arresto
 Con cierre
 Avec Arrêt

FD-574T/FD-575T
180 mm

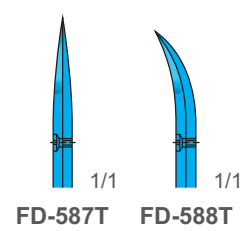
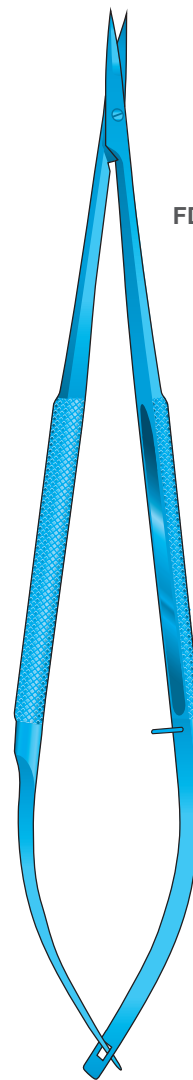

FD-587T/FD-588T
180 mm

DRIVERS





Tungsten-Carbide Inserts
Mit Hartmetalleinsätzen
Plaquettes en carbure de tungstène
Plaquetas de carburo de tungsteno
Inserti in carburo di tungsteno

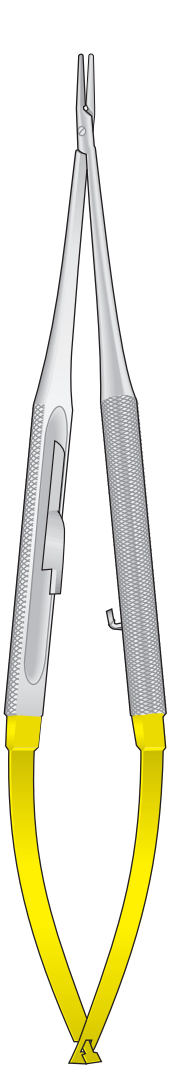

Diamond Tip
Diamantiert
Punta diamantata
Punta de diamante
Pointe de diamant

DRIVERS



 1/1
 1/1
FD-730 **FD-731**
150 mm 170 mm

CASTROVIEJO
Fine
Straight
Locking
Thick Jaw
Round Handle

CASTROVIEJO
FD-730 / FD-731
150 / 170 mm

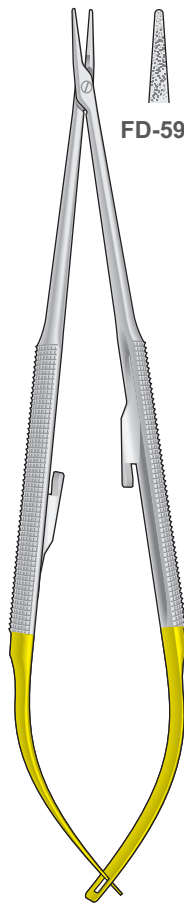

 1/1
 1/1
FD-599 **FD-600**

FD-599/FD-600
150 mm

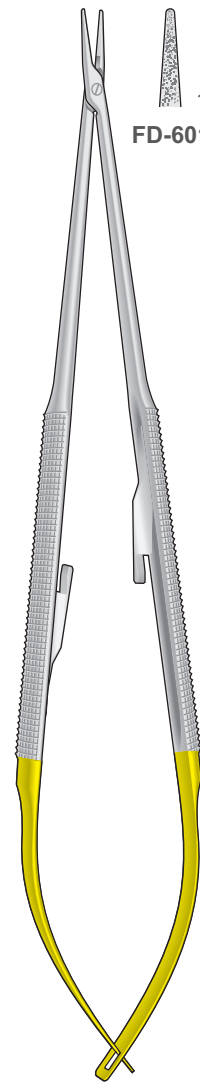

 1/1
 1/1
FD-601 **FD-602**

FD-601/FD-602
180 mm

Nadelhalter
 Needle Holders
 Port'aghi
 Portaagujas
 Porte aiguilles

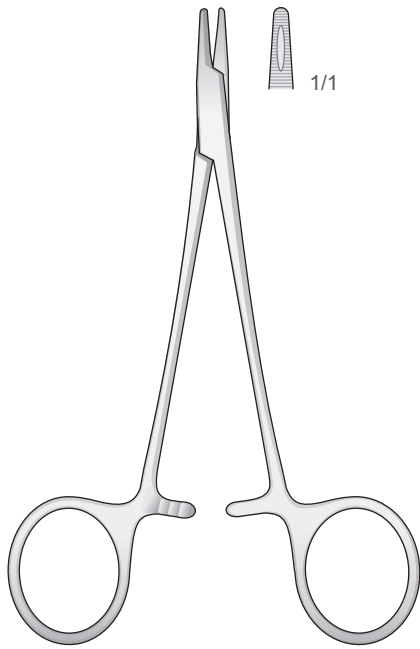

DERF
PH-39
 125 mm

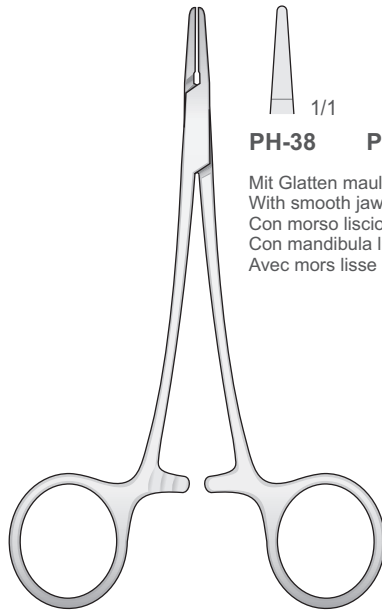

PH-38/PH-64
 120 mm

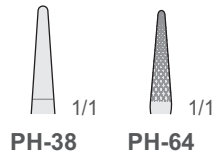

Mit Glatten maul
 With smooth jaws
 Con morso liscio
 Con mandibula lisa
 Avec mors lisse

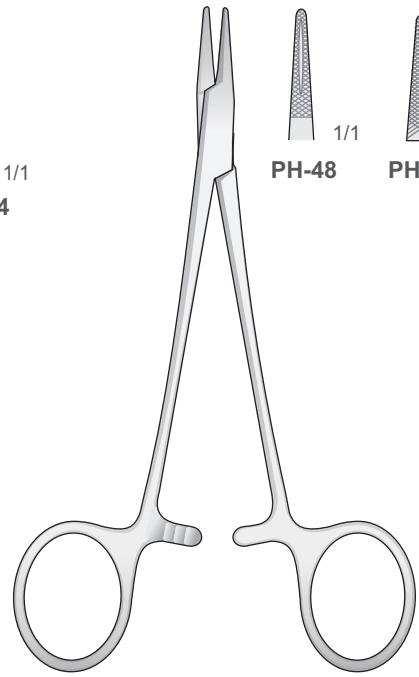

HALSEY
PH-48/PH-63
 130 mm

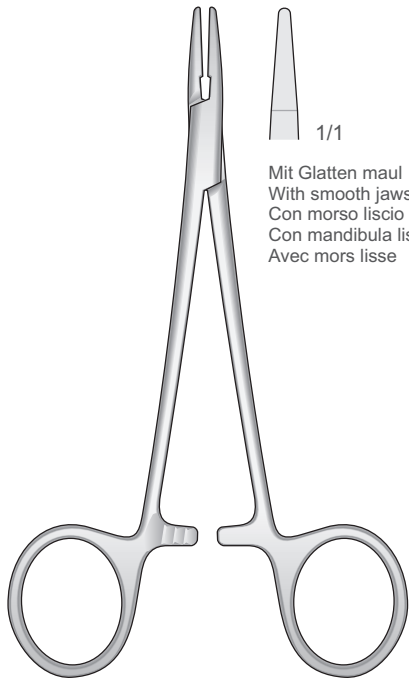
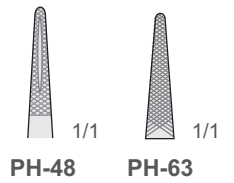

HALSEY
PH-37
 130 mm



Mit Glatten maul
 With smooth jaws
 Con morso liscio
 Con mandibula lisa
 Avec mors lisse

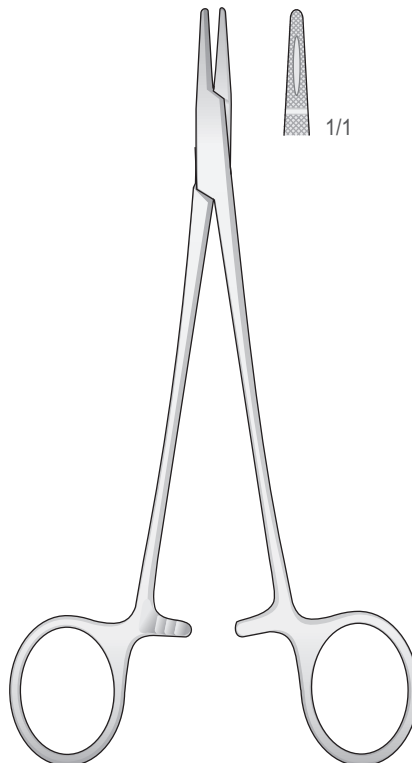

CRILE-WOOD
PH-61
 150 mm

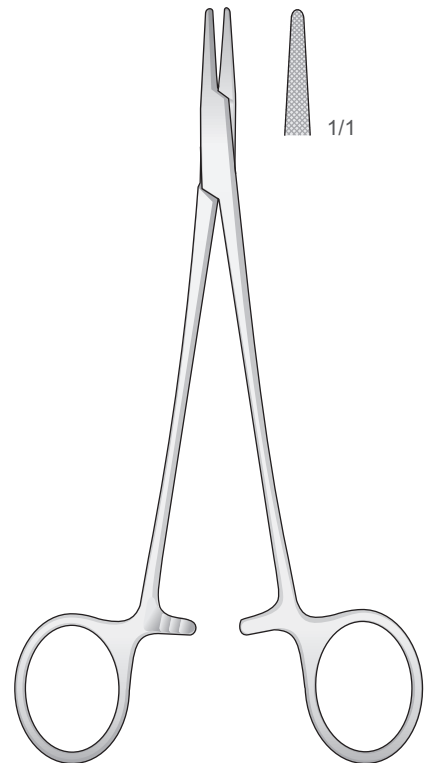
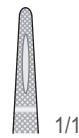

CRILE-MURRAY
PH-62
 150 mm

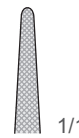

DRIVERS

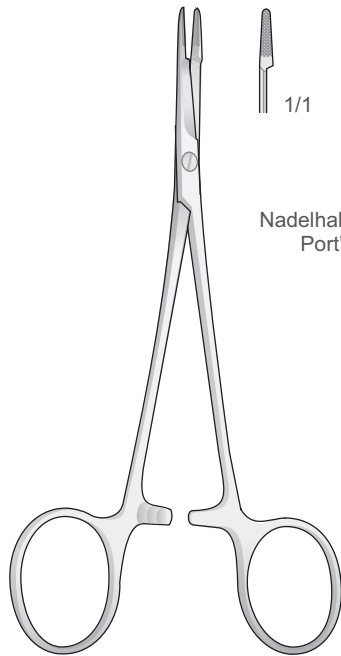

MINI-OLSEN-HEGAR
BM-61
120 mm

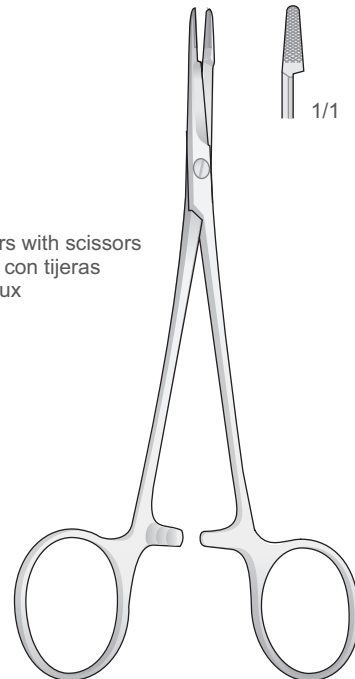

OLSEN-HEGAR
BM-62
140 mm

Nadelhalter mit Schere - Needle holders with scissors
Port'aghi con forbici - Portaagujas con tijeras
Porte aiguilles avec ciseaux

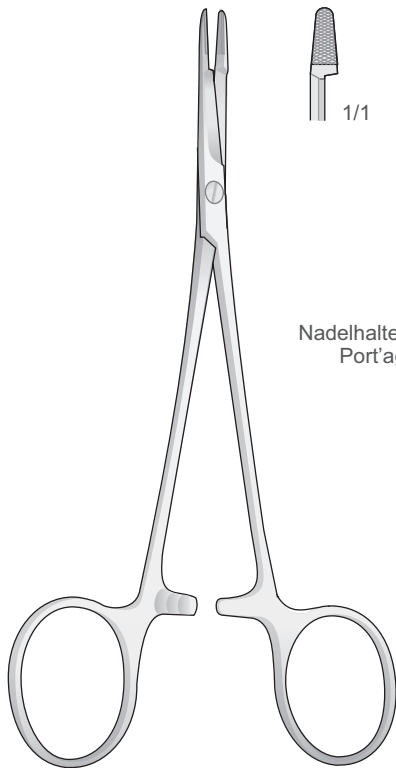

OLSEN-HEGAR
BM-63
170 mm

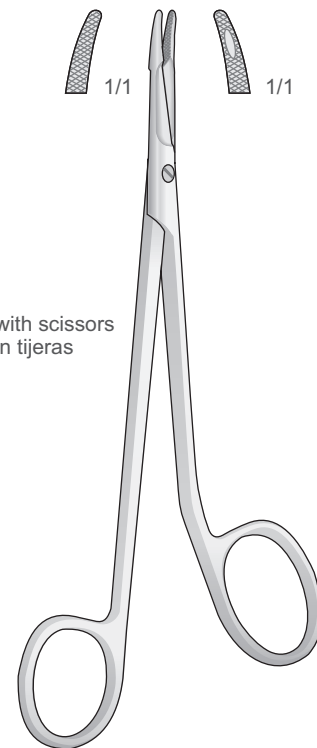

MINI-GILLIES
PO-59
145 mm

Nadelhalter mit Schere - Needle holders with scissors
Port'aghi con forbici - Portaagujas con tijeras
Porte aiguilles avec ciseaux

Nadelhalter
 Needle Holders
 Port'aghi
 Portaagujas
 Porte aiguilles

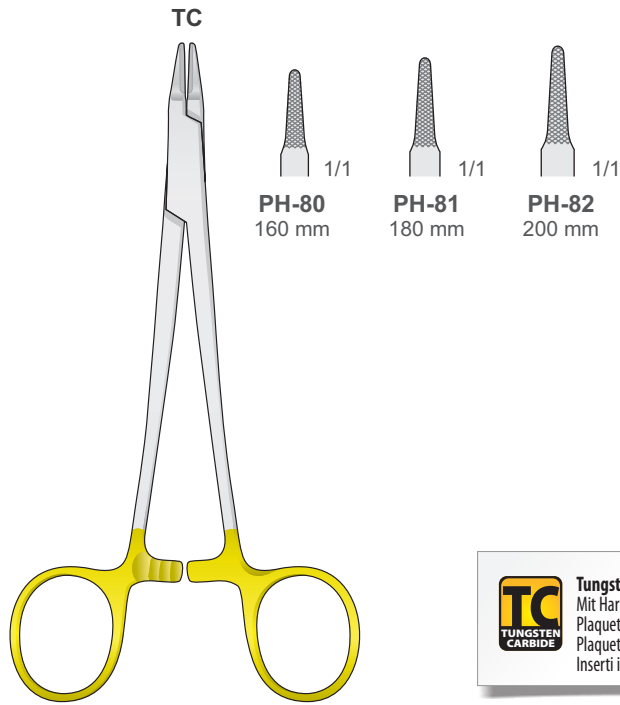

RYDER
 PH-80/PH-82

DRIVERS

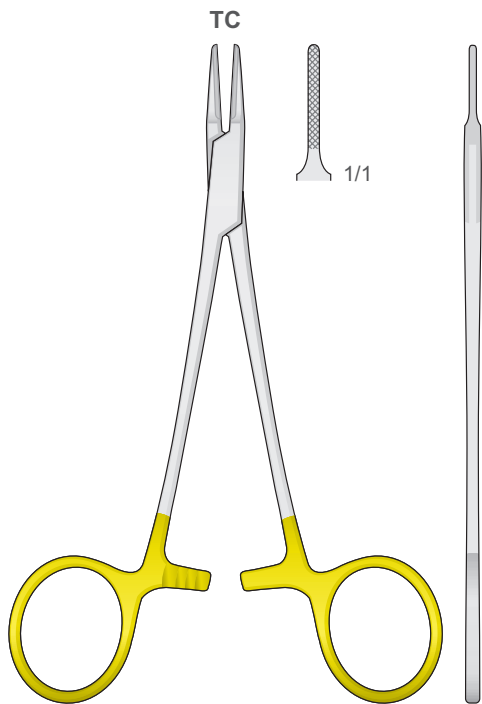

RYDER
 PH-83
 140 mm

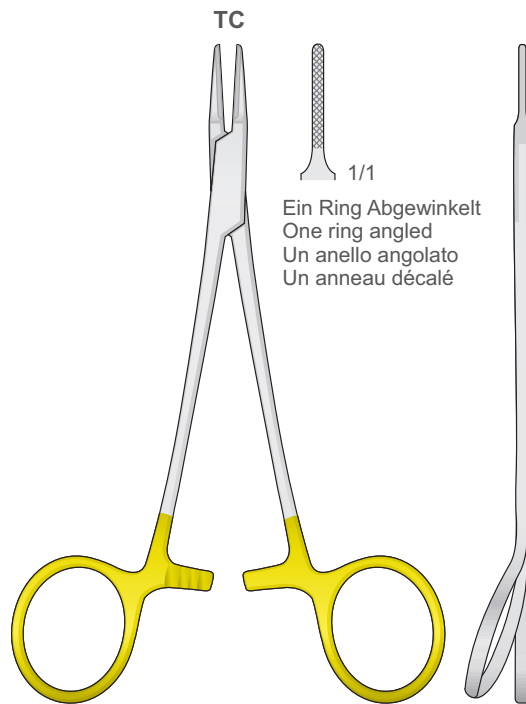

PH-84
 140 mm



Tungsten-Carbide Inserts
Mit Hartmetalleinsätzen
Plaquettes en carbure de tungstène
Plaquetas de carburo de tungsteno
Inserti in carburo di tungsteno

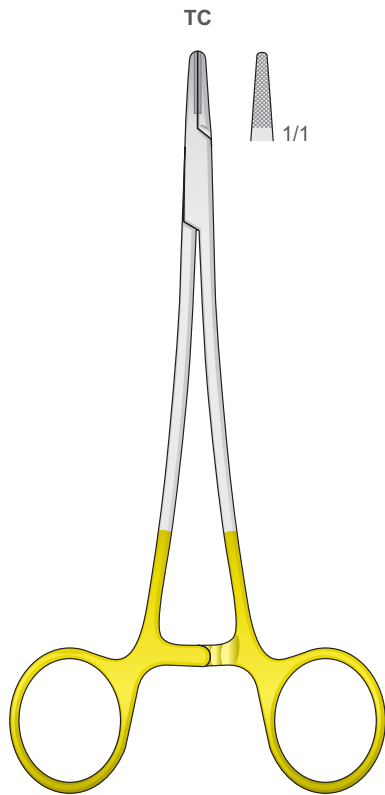

CRILE-WOOD
PH-79
145 mm

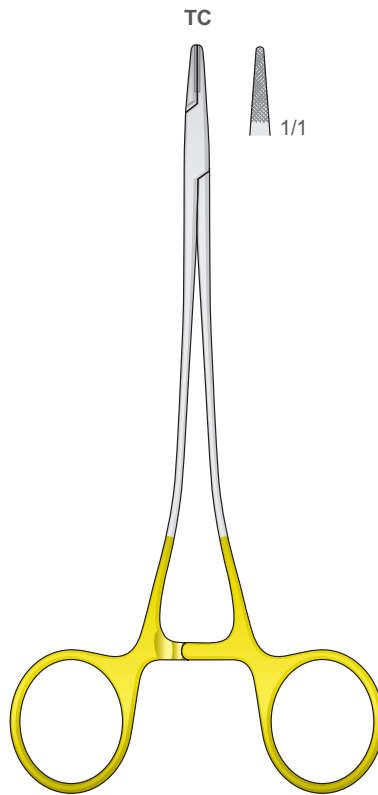

FINE SWEDISH PATTERN
PH-85
150 mm

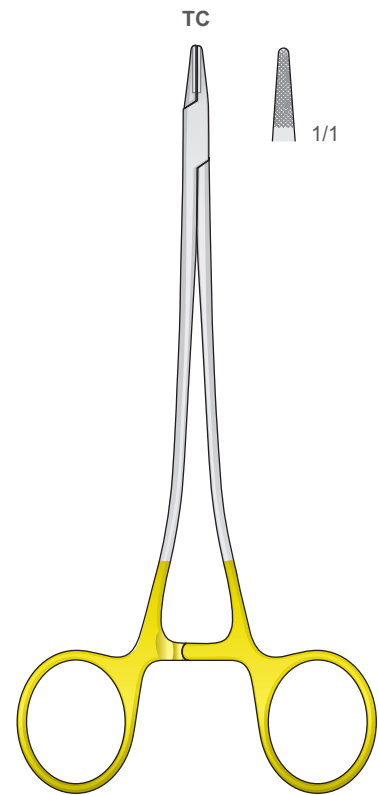

SWEDISH MOD.
PH-106
150 mm

Nadelhalter
Needle Holders
Port'aghi
Portaagujas
Porte aiguilles



Tungsten-Carbide Inserts
Mit Hartmetalleinsätzen
Plaquettes en carbure de tungstène
Plaquetas de carburo de tungsteno
Inserti in carburo di tungsteno

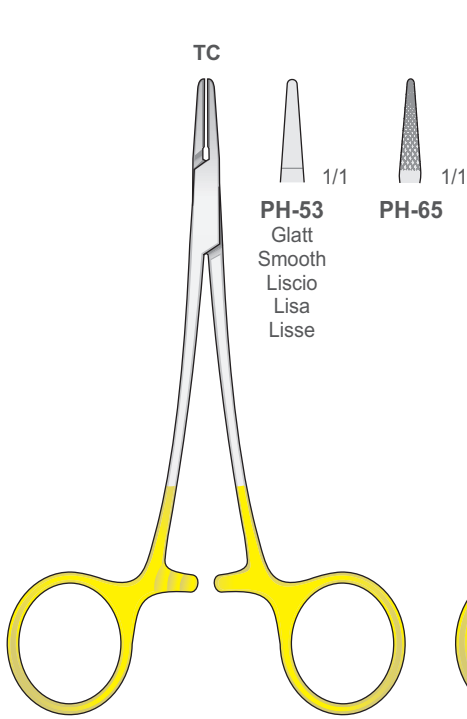

PH-53/PH-65
120 mm

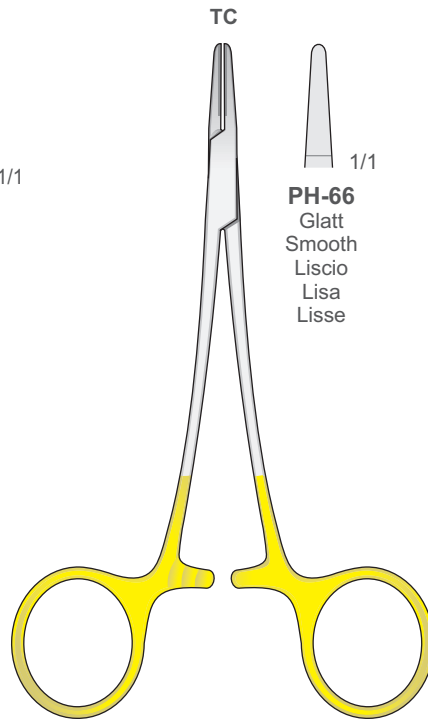

WEBSTER PH-66
130 mm

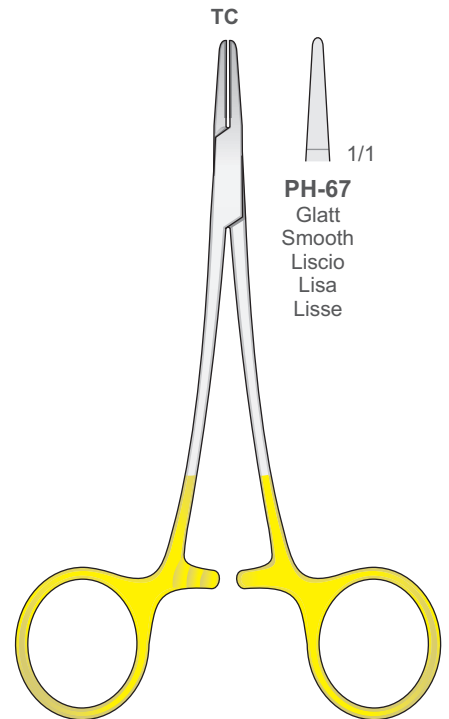

HALSEY PH-67
130 mm

DRIVERS

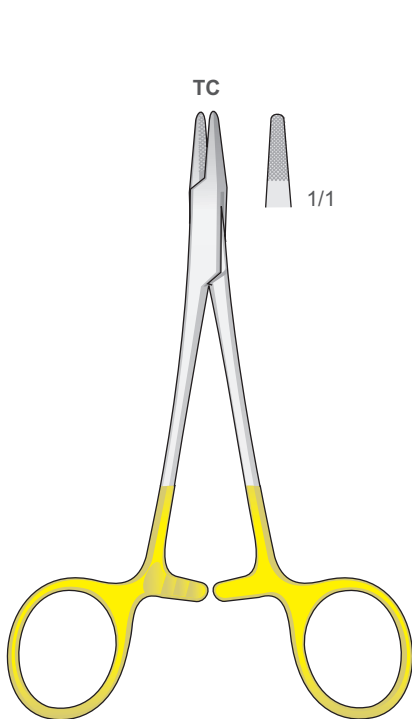

DERF PH-69
115 mm

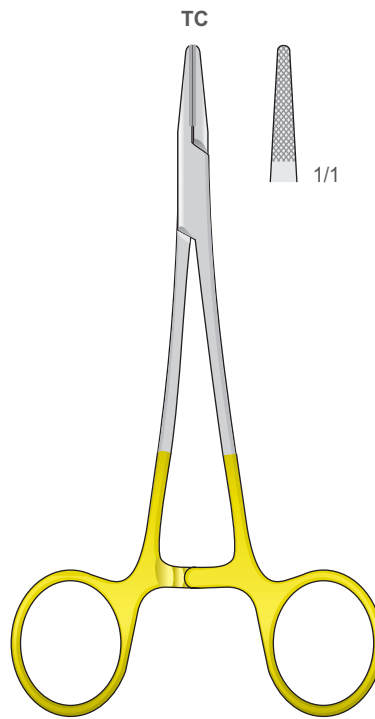

CONVERSE PH-68
130 mm

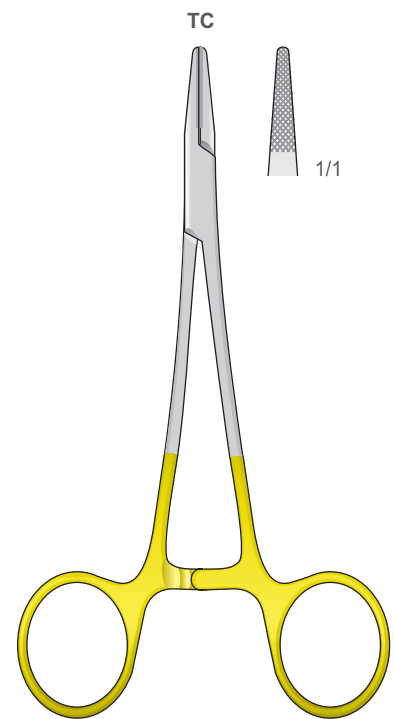

HALSEY PH-73
130 mm



Tungsten-Carbide Inserts
 Mit Hartmetalleinsätzen
 Plaquettes en carbure de tungstène
 Plaquetas de carburo de tungsteno
 Inserti in carburo di tungsteno

Nadelhalter
 Needle Holders
 Port'aghi
 Portaagujas
 Porte aiguilles

DRIVERS

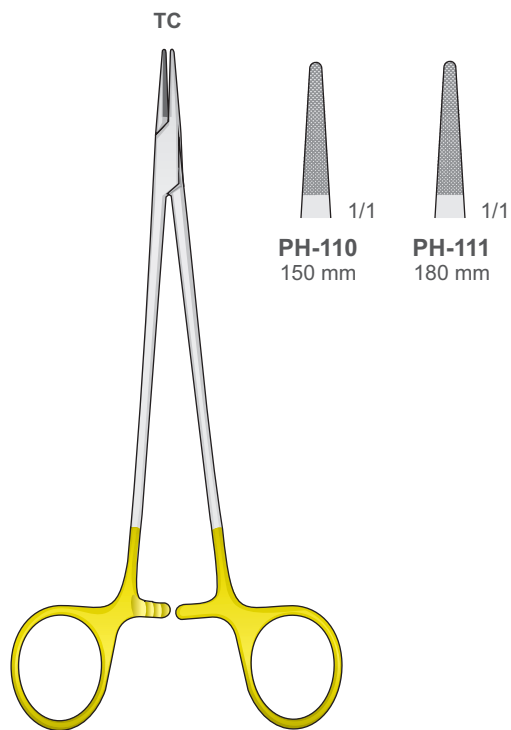

DE BAKEY
PH-110/PH-111

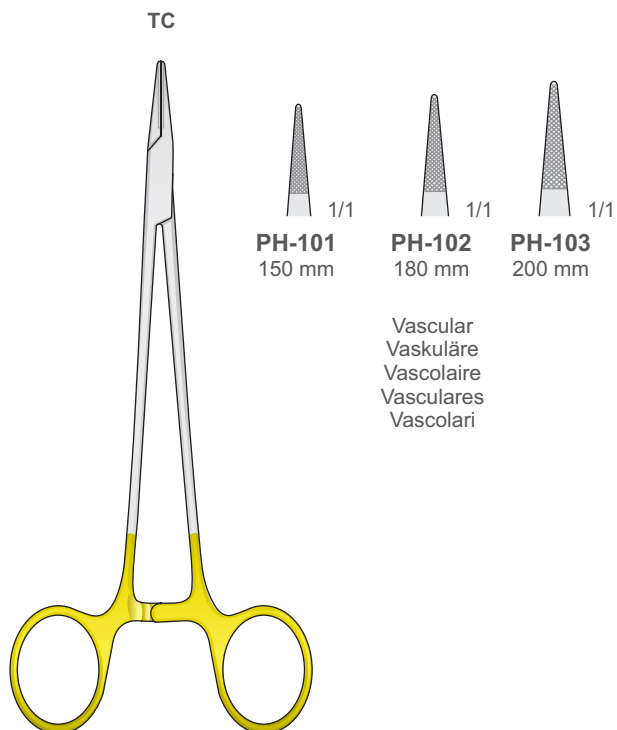

MICRO-VASCULAR
PH-101/PH-102/PH-103

Vascular
 Vaskuläre
 Vasculaire
 Vasculares
 Vascolari

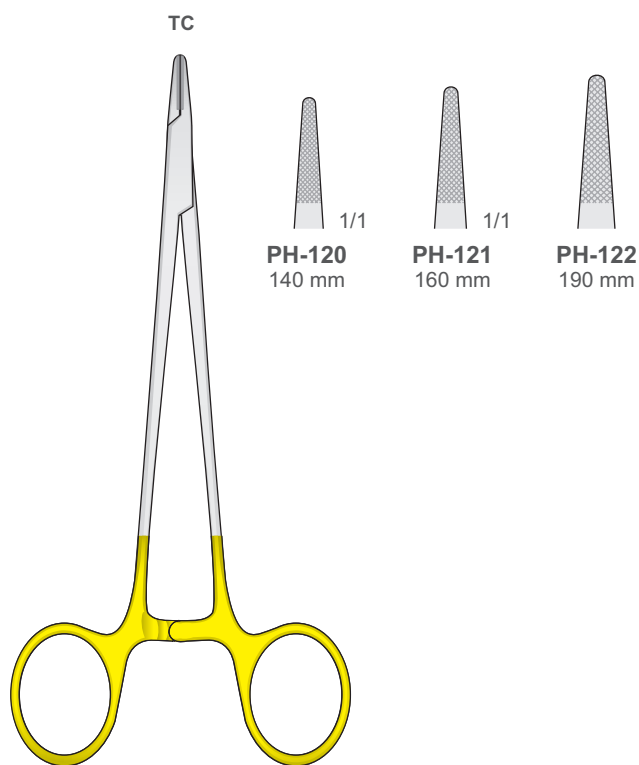

HEGAR
PH-120/PH-121/PH-122

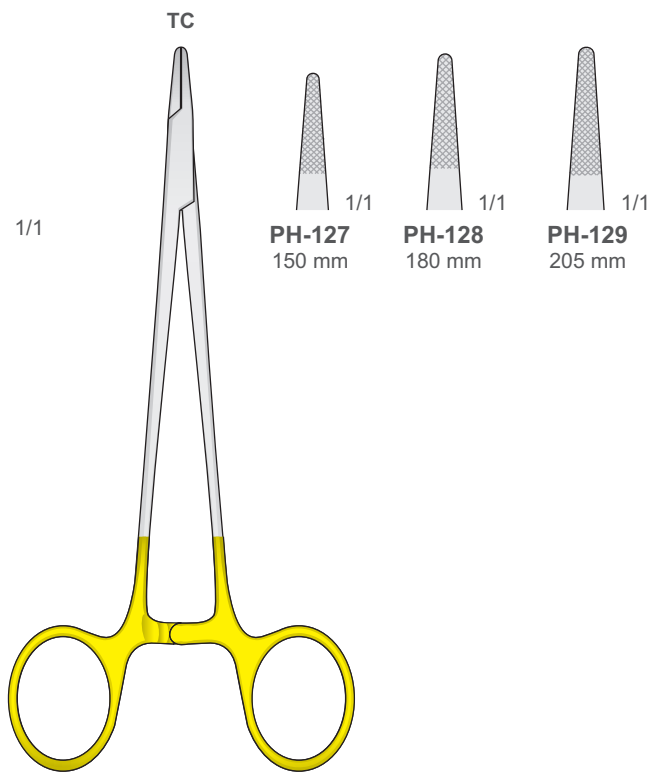

MAYO-HEGAR-FINO
PH-127/PH-128/PH-129

Nadelhalter
Needle Holders
Port'aghi
Portaagujas
Porte aiguilles



Tungsten-Carbide Inserts
Mit Hartmetalleinsätzen
Plaquettes en carbure de tungstène
Plaquetas de carburo de tungsteno
Inserti in carburo di tungsteno

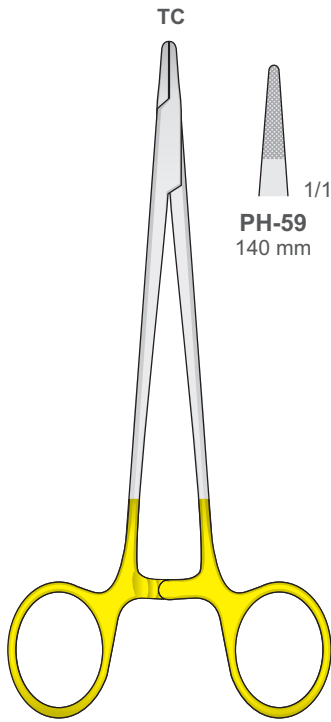

HEGAR
PH-59/PH-72/PH-75/PH-76

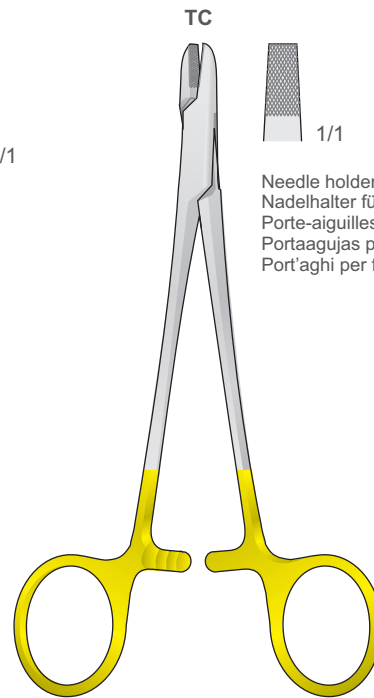
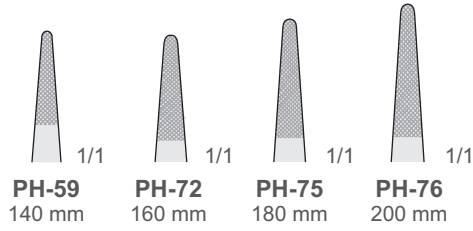

PH-58
150 mm

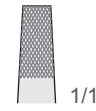

Needle holders for wire
Nadelhalter für drähte
Porte-aiguilles pour fil métallique
Portaagujas para hilo metálico
Port'aghi per fili metallici

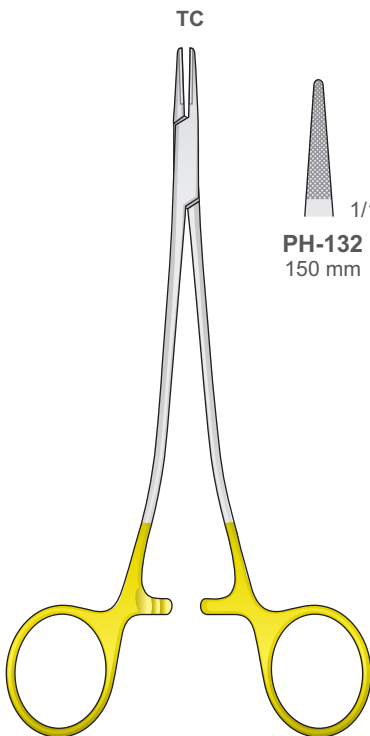

SAROT
PH-132/PH-133/PH-134

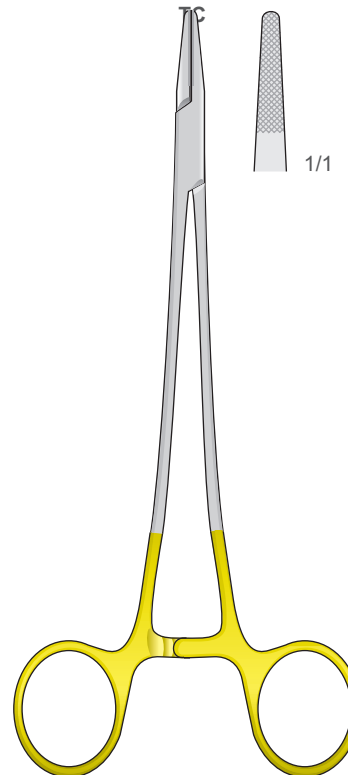
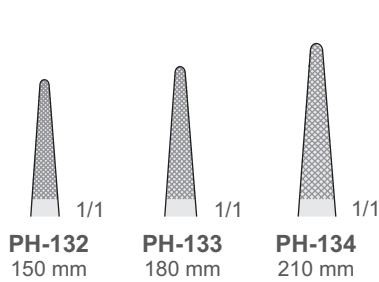

CRILE-WOOD
PH-77
180 mm

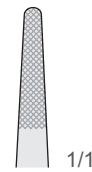

DRIVERS



Tungsten-Carbide Inserts
 Mit Hartmetalleinsätzen
 Plaquettes en carbure de tungstène
 Plaquetas de carburo de tungsteno
 Inserti in carburo di tungsteno

Nadelhalter
 Needle Holders
 Port'aghi
 Portaagujas
 Porte aiguilles

DRIVERS

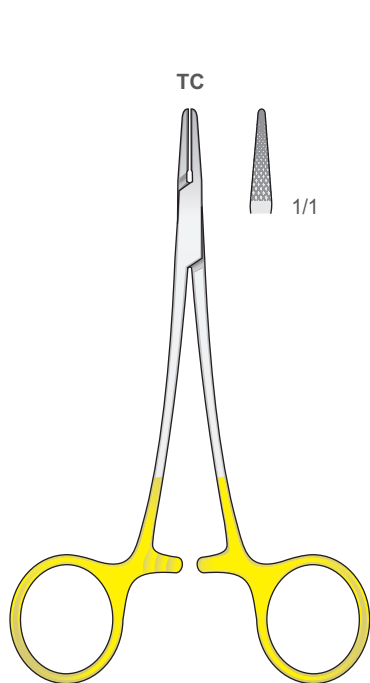

PH-99
120 mm

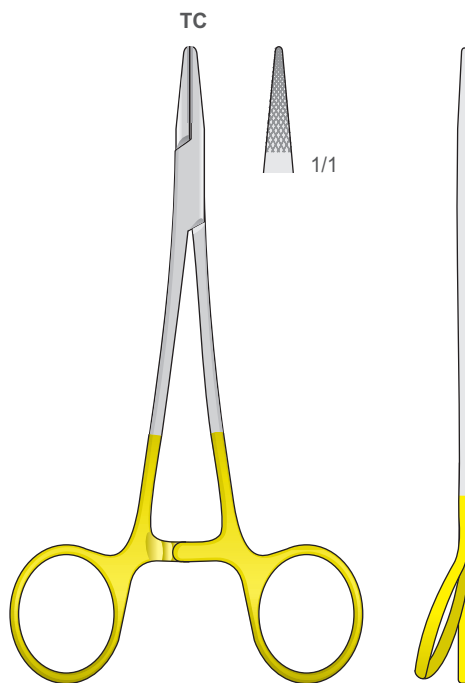

CRILE-WOOD PH-100
150 mm

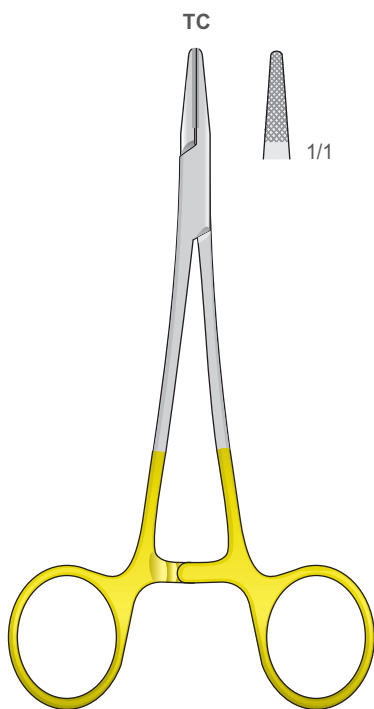

BABY-CRILE-WOOD PH-54
150 mm

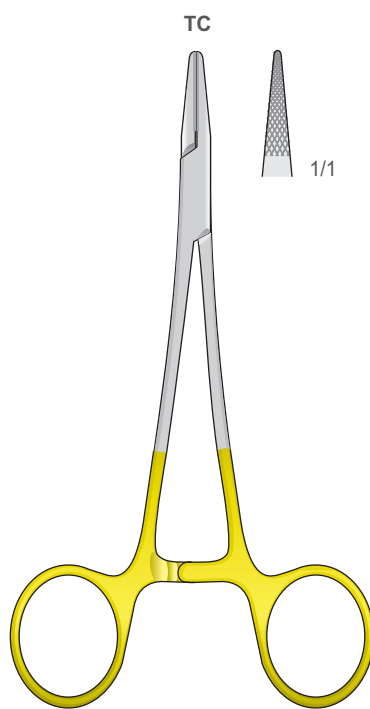

CRILE-WOOD PH-71
150 mm



CRILE-WOOD PH-90
150 mm

Nadelhalter
Needle Holders
Port'aghi
Portaagujas
Porte aiguilles



Tungsten-Carbide Inserts
Mit Hartmetalleinsätzen
Plaquettes en carbure de tungstène
Plaquetas de carburo de tungsteno
Inserti in carburo di tungsteno

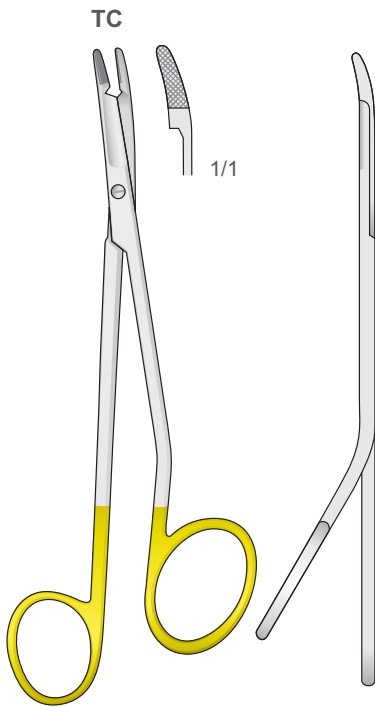

**MINI-GILLIES
PO-99**
145 mm

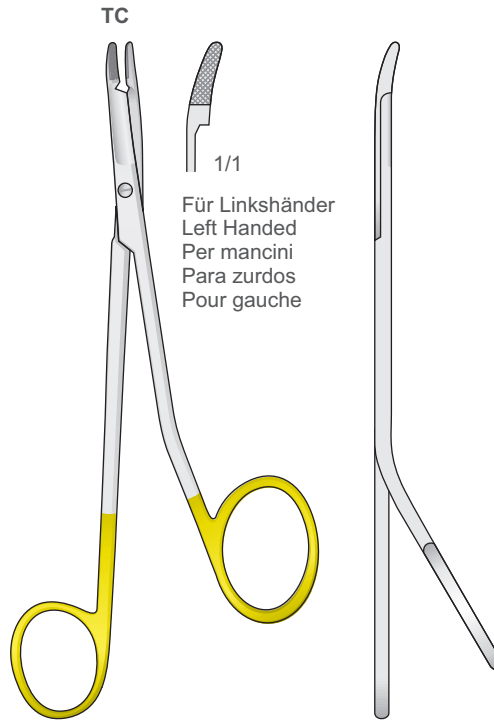

**MINI-GILLIES
PO-99L**
145 mm

Für Linkshänder
Left Handed
Per mancini
Para zurdos
Pour gauche

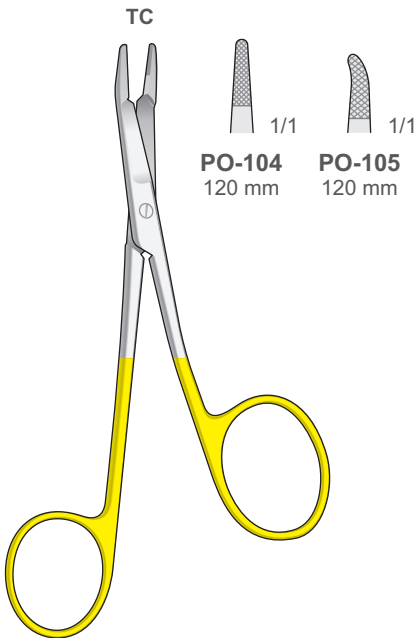

**FOSTER-GILLIES
PO-104/PO-105**
120 mm

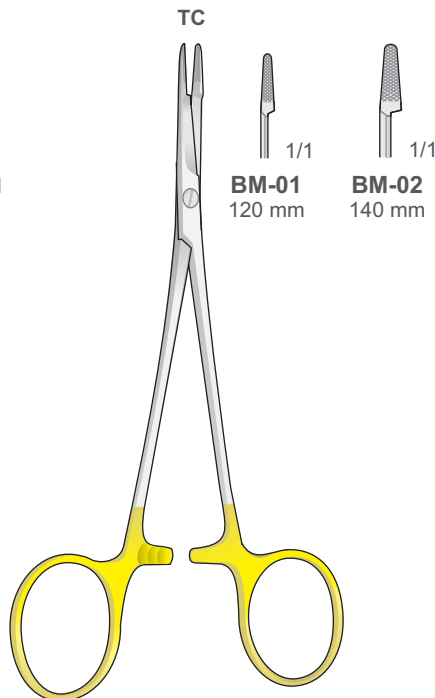

**OLSEN-HEGAR
BM-01/BM-02**

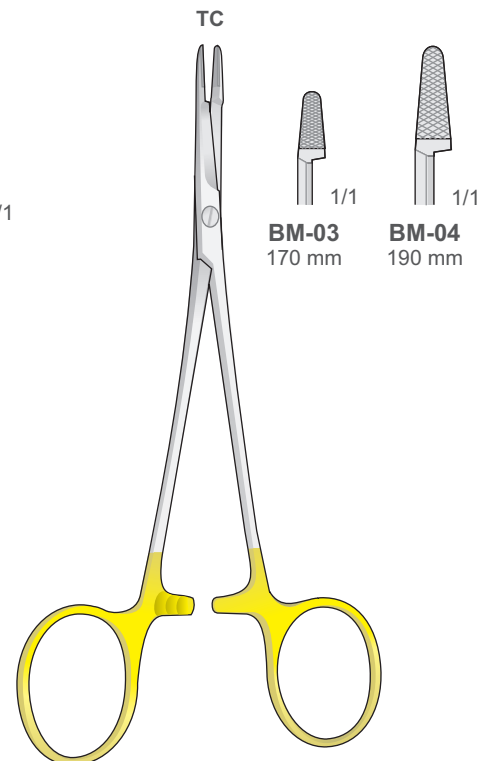

**OLSEN-HEGAR
BM-03/BM-04**

DRIVERS

Nadelhalter
Needle Holders
Port'aghi
Portaagujas
Porte aiguilles

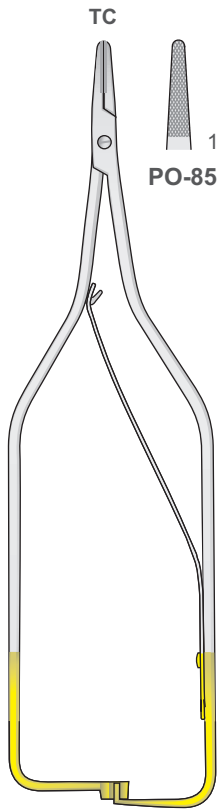

ARRUGA
PO-85/PO-87
160 mm

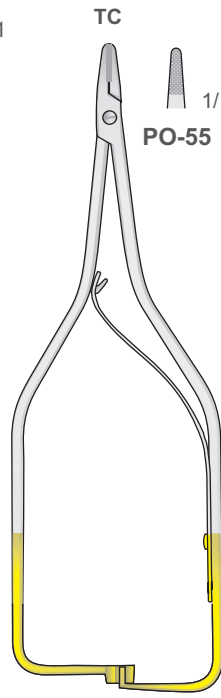

BOYNTON
PO-55/PO-56
120 mm

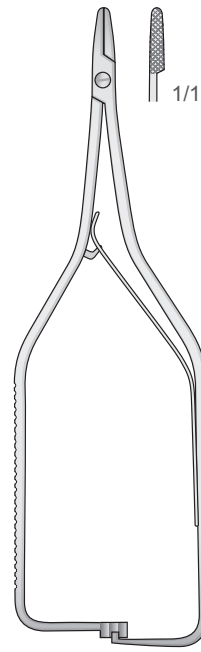

BOYNTON
PO-88
120 mm

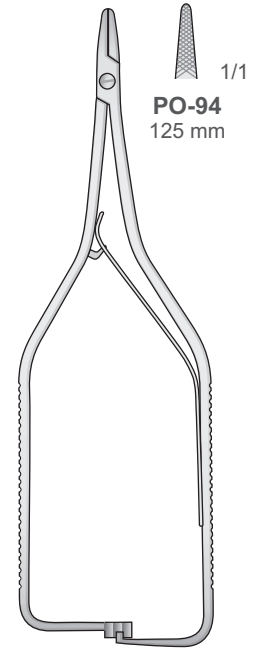

BOYNTON
PO-94
125 mm

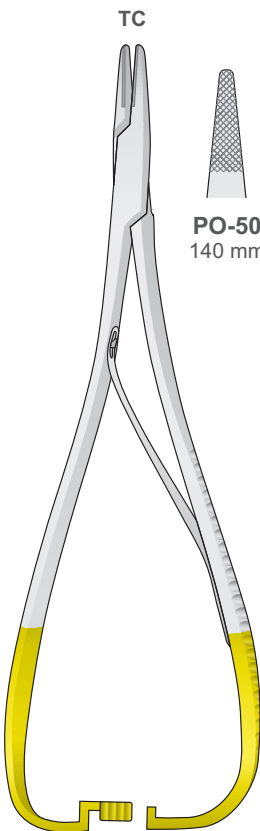

MATHIEU
PO-50/PO-52

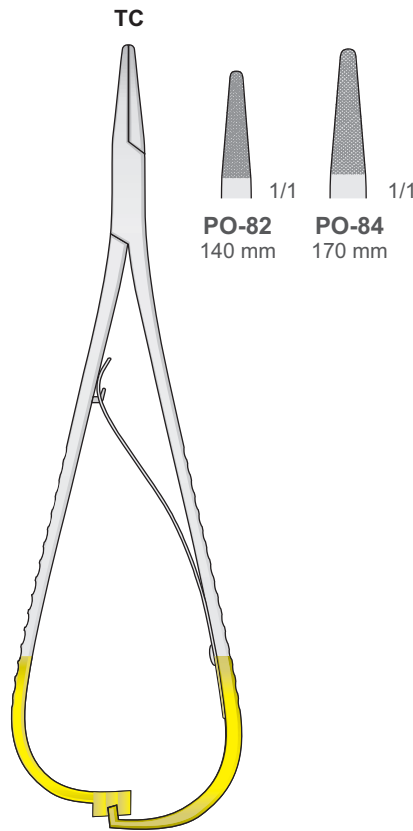

MATHIEU
PO-82/PO-84

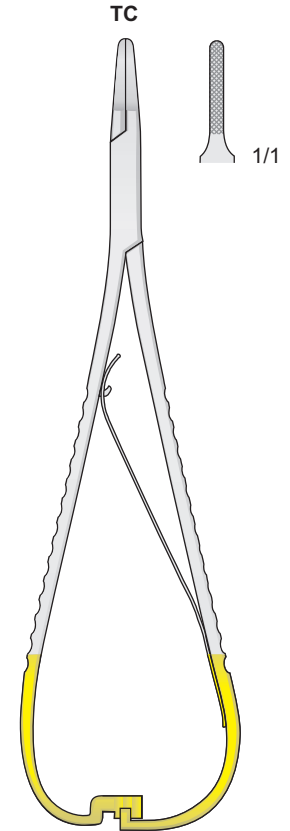

LICHTENBERG
PO-86
175 mm

Nadelhalter
 Needle Holders
 Port'aghi
 Portaagujas
 Porte aiguilles

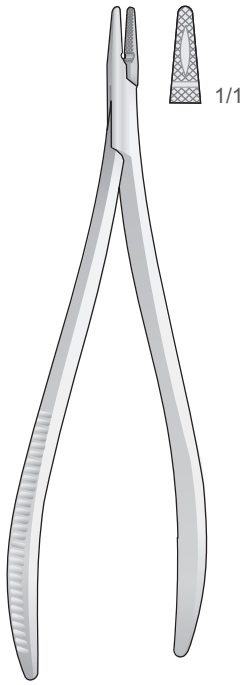

CRILE
PO-37
 150 mm

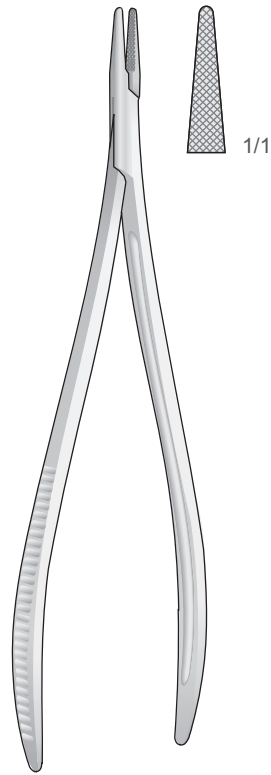

TÖNNIS
PO-38
 190 mm

Schlankesmodell - Delicate pattern - Modello fine
 Modelo delegado - Modèle fin

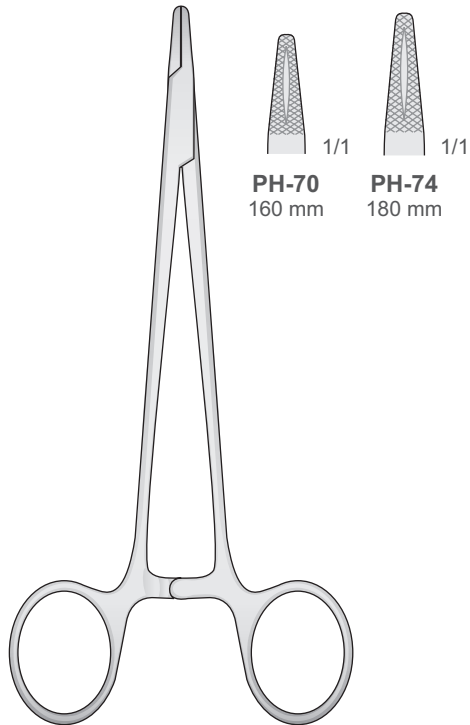

MAYO-HEGAR
PH-70/PH-74

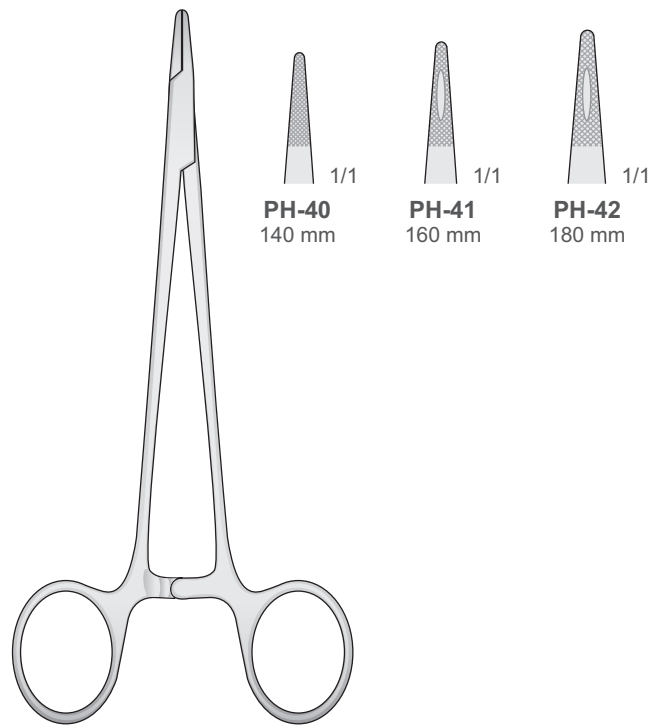

MAYO-HEGAR
PH-40/PH-42

DRIVERS

Nadelhalter
 Needle Holders
 Port'aghi
 Portaagujas
 Porte aiguilles

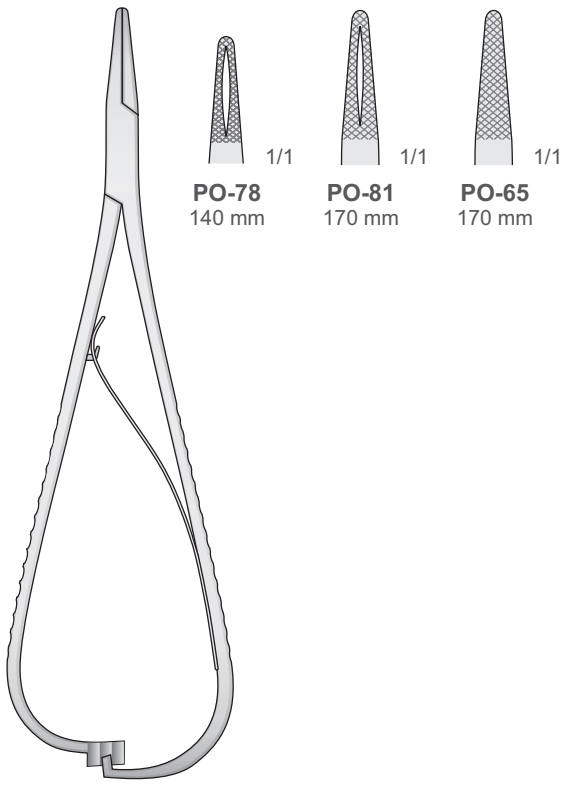

MATHIEU
 PO-65/PO-81

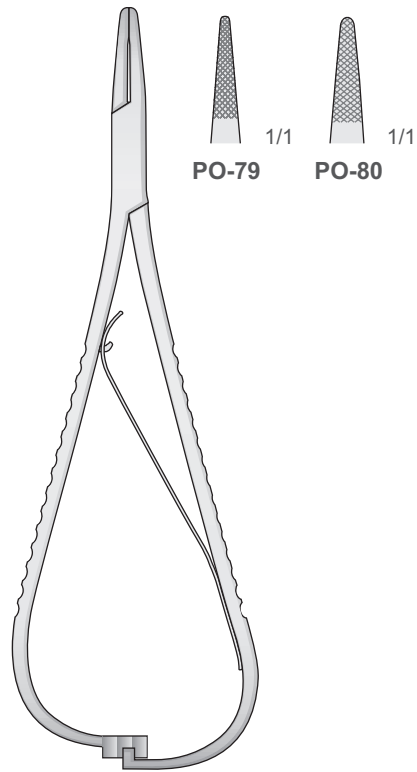

MATHIEU
 PO-79/PO-80
 140 mm

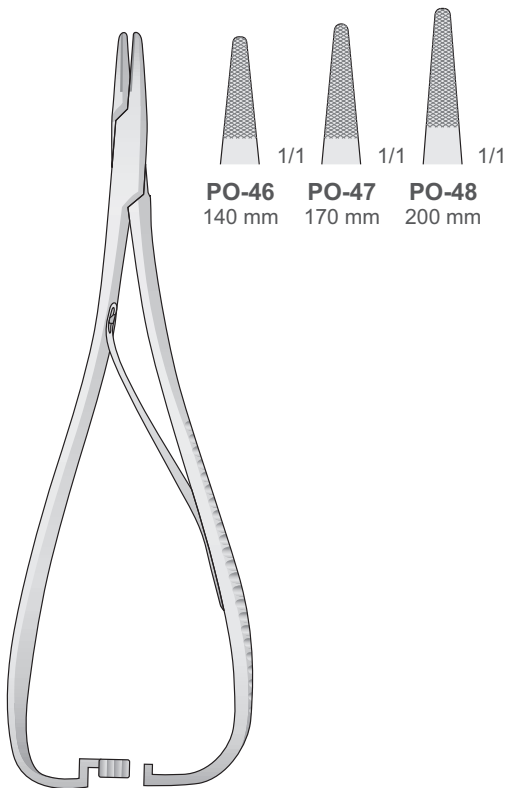

MATHIEU
 PO-46/PO-48

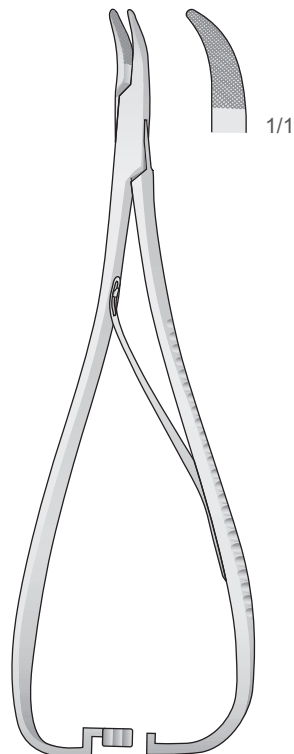

PO-40
 140 mm

Nadelhalter
 Needle Holders
 Port'aghi
 Portaagujas
 Porte aiguilles

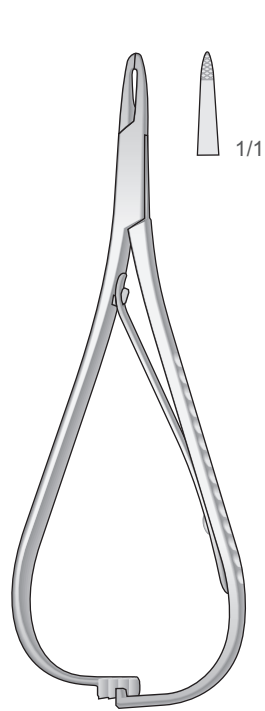

MATHIEU
PO-45
 125 mm

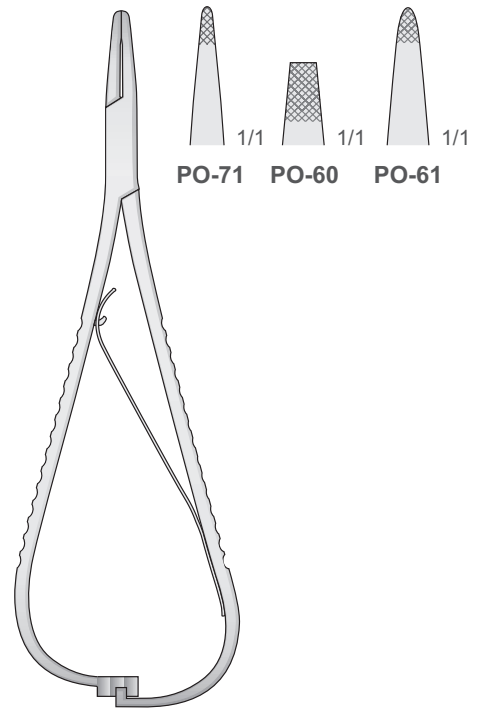

MATHIEU
PO-60/PO-71
 140 mm

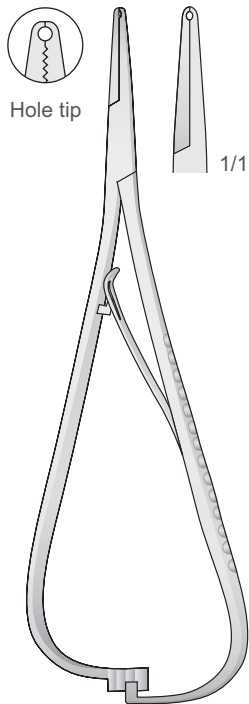

SMAHA
PO-68
 140 mm

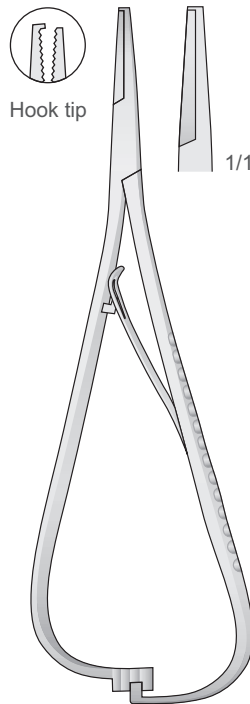

SMAHA
PO-69
 140 mm

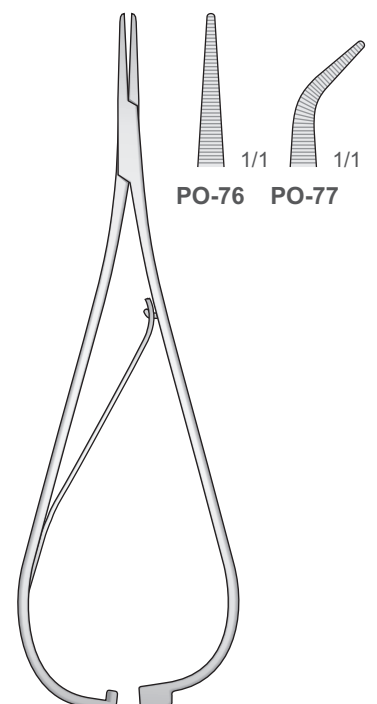

SMAHA
PO-76/PO-77
 140 mm

DRIVERS

• Hemostats / Grasping Forceps

165 | Towel Clamps

167 | Sponge & Dressing Forceps

168 | Hemostatic Forceps

174 | Tissue Grasping Forceps



HEMOSTATS
GRASPING

Tuchklemmen
Towel Clamps
Fissateli
Pinzas de campo
Pincas fixe-compresses

Towel Clamps

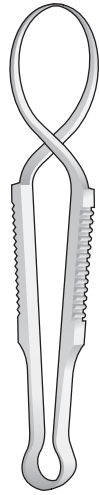

SCHAEDEL
BF-38
85 mm

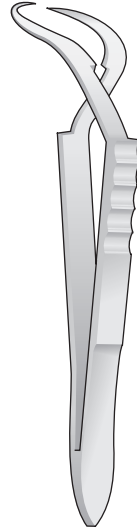

JONES
BF-48
90 mm



FAURE
BF-40
85 mm

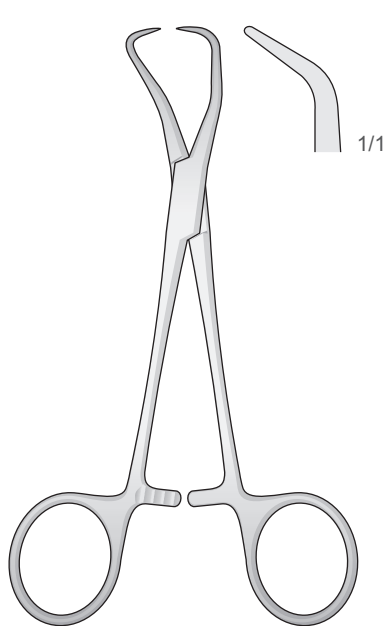

BACKHAUS
BF-42/BF-46

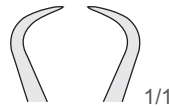

BF-42
90 mm

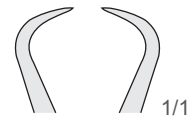

BF-41
100 mm

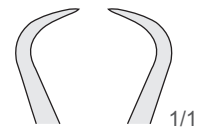

BF-44
110 mm

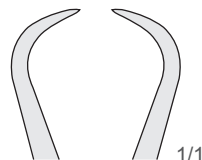

BF-46
130 mm

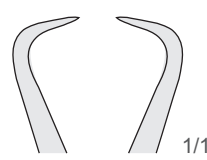

BF-43
135 mm

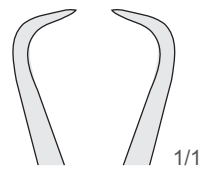

BF-45
140 mm

HEMOSTATS
GRASPING

Tuchklemmen
Towel Clamps
Fissateli
Pinzas de campo
Pincas fixe-compresses

HEMOSTATS
GRASPING

Für Papiertücher
For paper cloths
Per teli di carta
Para paños
Pour papier

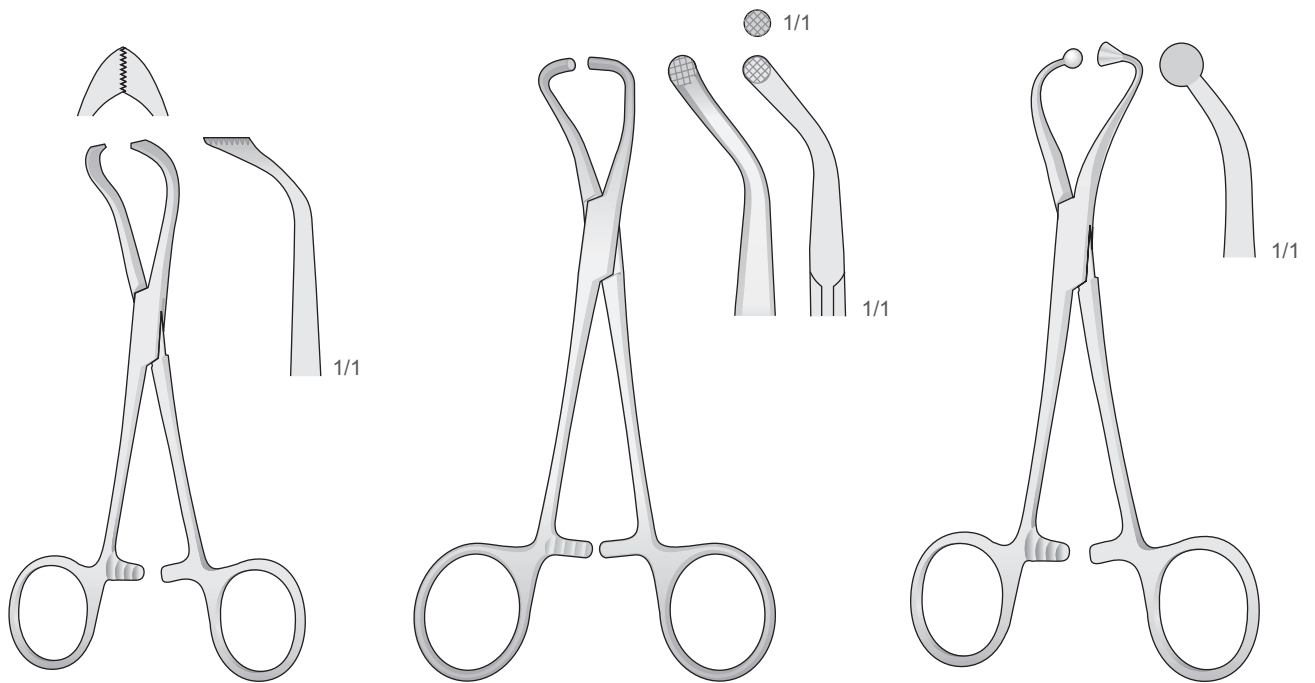

LORNA
BF-50
100 mm

BF-52
130 mm

BF-75
140 mm

Schwamm und Tamponzangen
 Sponge and Dressing Forceps
 Pinze per tamponi e sponge
 Pinzas para esponja y tampones
 Pincas pour éponges et à pansement

Sponge and Dressing Forceps

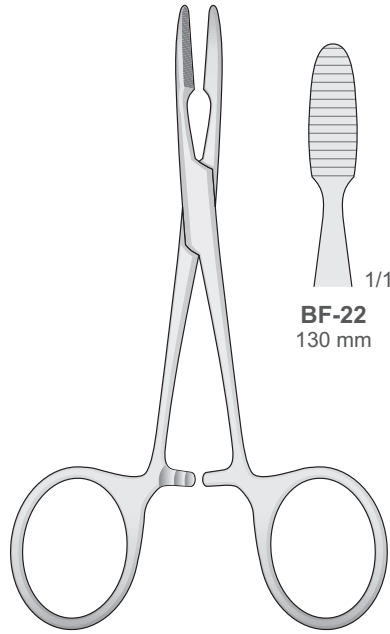

BF-22
130 mm

BF-24
140 mm

PEAN-MURPHY
BF-22/BF-24

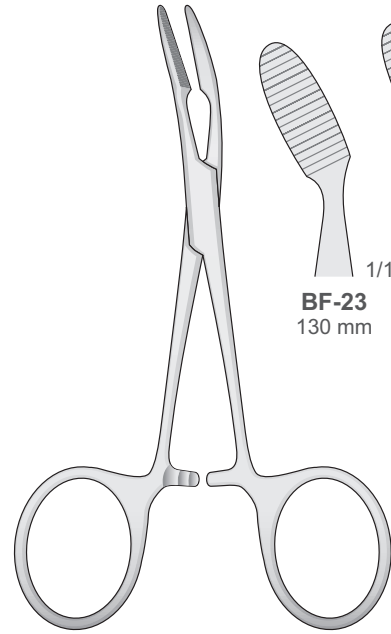

BF-23
130 mm

BF-25
140 mm

PEAN-MURPHY
BF-23/BF-25

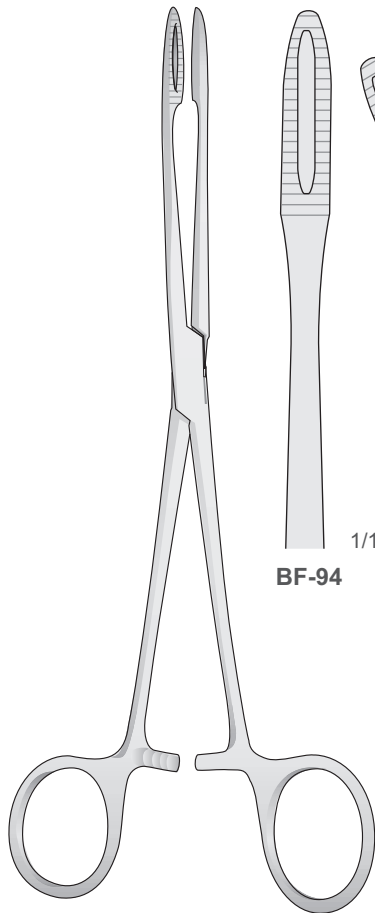

BF-94

BF-95

GROSS
BF-94/BF-95
200 mm

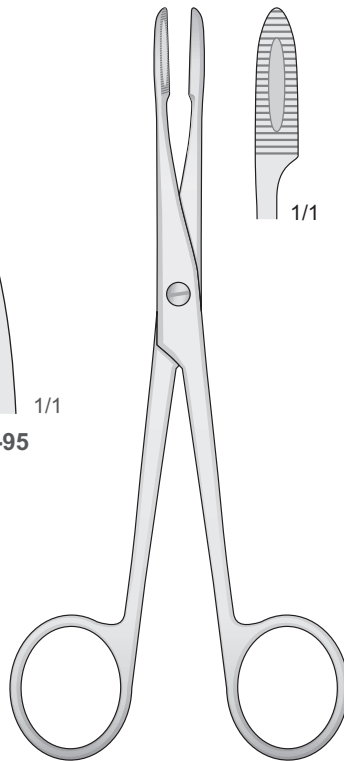

GROSS
BF-10 130 mm
BF-12 160 mm

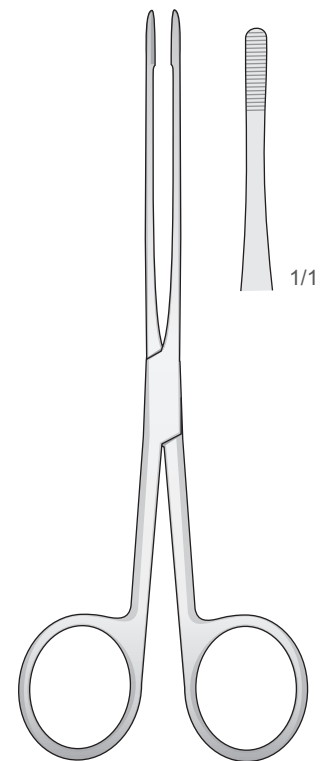

LISTER
BF-20
150 mm

Sinus klemmen
 Sinus forceps
 Pinze Sinus
 Pinzas para seno
 Pincas à Sinus

HEMOSTATS
GRASPING

Hemostatic Forceps

Arterienklemmen
 Hemostatic Forceps
 Pinze emostática
 Pinzas hemostáticas
 Pinces hémostatiques

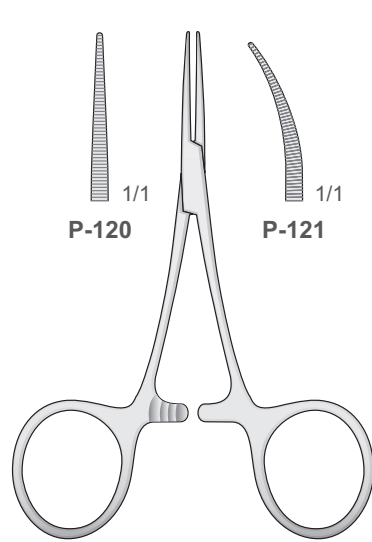

HARTMANN/BABY-MOSQUITO
P-120/P-121
 95 mm

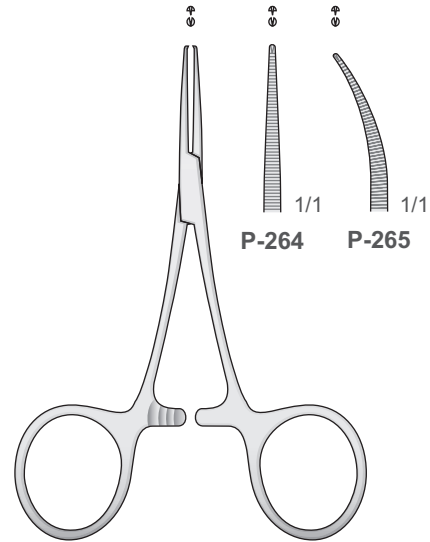

HARTMANN/BABY-MOSQUITO
P-264/P-265
 95 mm

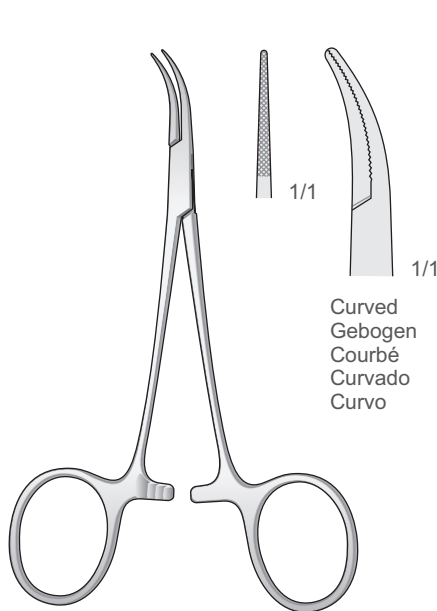

DANDY-MOSQUITO
P-332
 120 mm

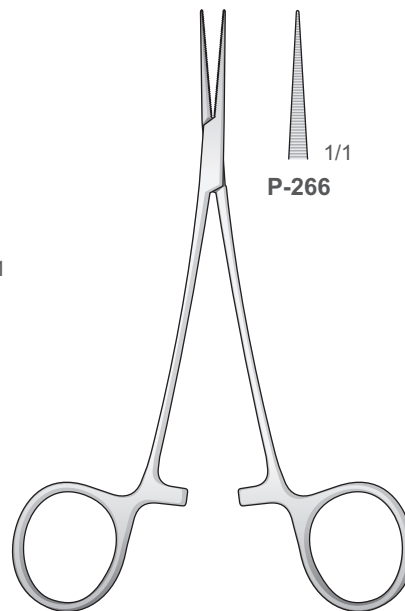

JACOBSON-MICRO
P-266
 130 mm

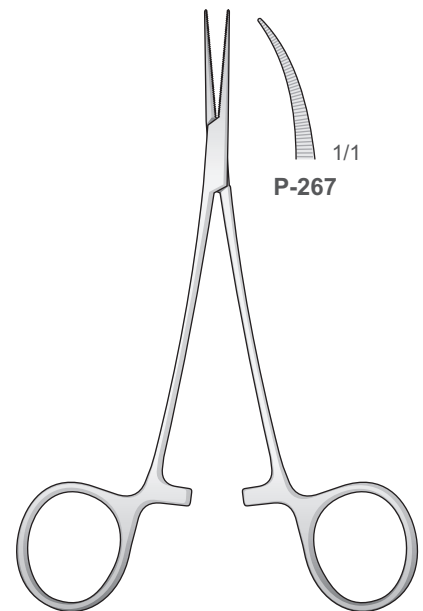

JACOBSON-MICRO
P-267
 130 mm

HEMOSTATS
 GRASPING

Arterienklemmen
 Hemostatic Forceps
 Pinze emostatiche
 Pinzas hemostáticas
 Pincas hémostatiques

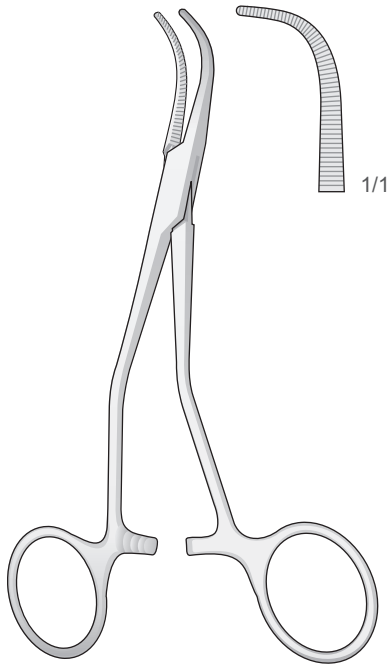

P-15
 130 mm

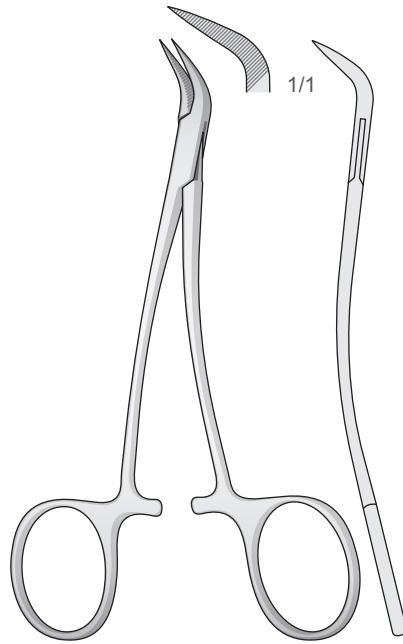

**PEET
 DR-40**
 120 mm

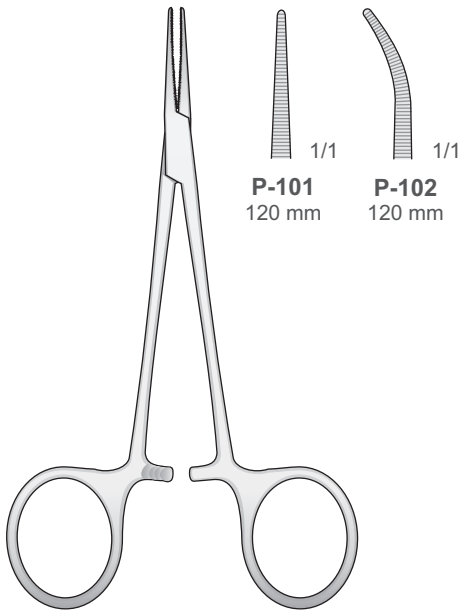

P-101
 120 mm

P-102
 120 mm

**MICRO-HALSTED
 P-101/P-102**

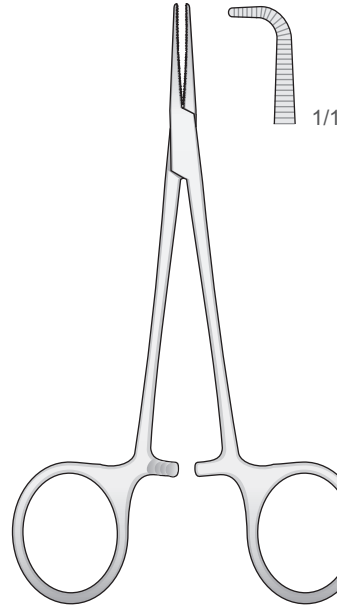

**MICRO-HALSTED
 P-135**
 115 mm

HEMOSTATS
 GRASPING

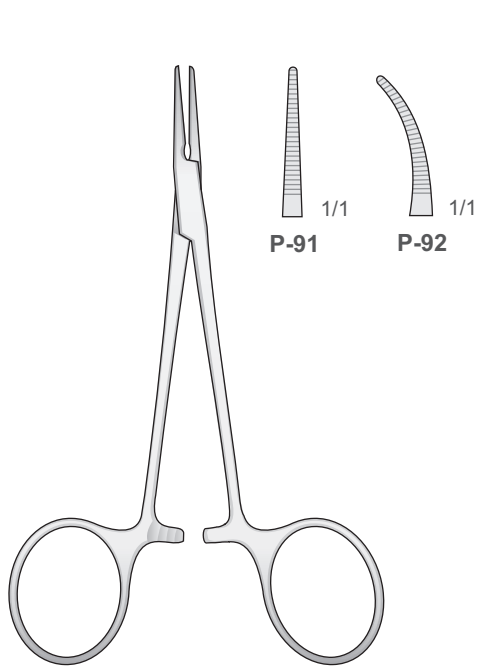

HALSTED
P-91/P-92
 125 mm

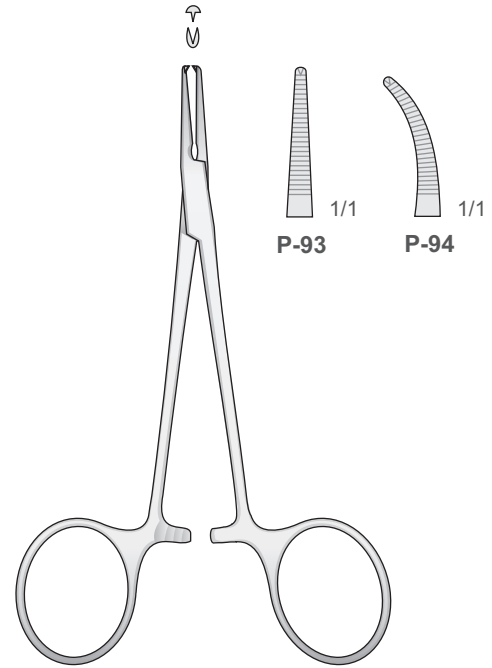

HALSTED
P-93/P-94
 125 mm

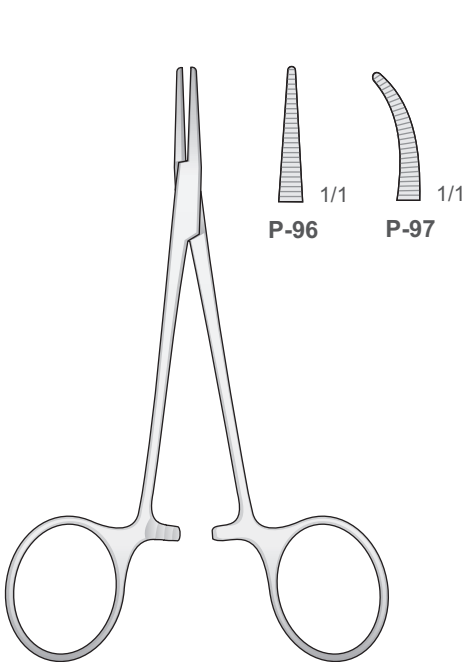

HALSTED-MOSQUITO
P-96/P-97
 120 mm

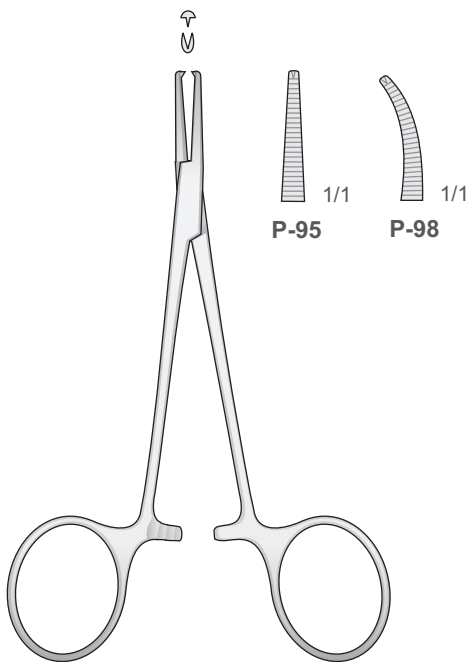

HALSTED-MOSQUITO
P-95/P-98
 120 mm

HEMOSTATS
 GRASPING

Arterienklemmen
 Hemostatic Forceps
 Pinze emostatiche
 Pinzas hemostáticas
 Pincas hémostatiques

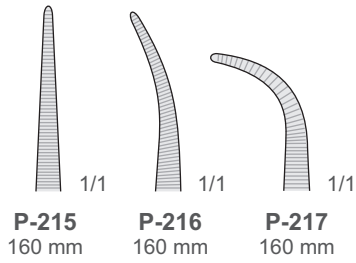
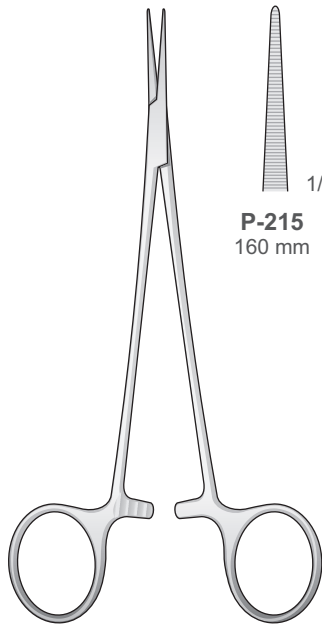

P-215/P-217
160 mm

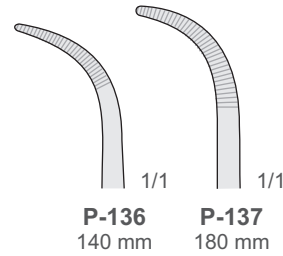
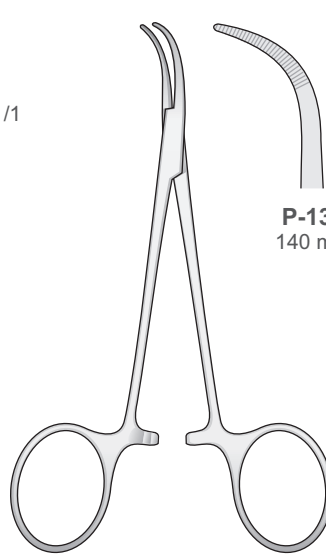

BABY-MIXTER
P-136/P-137

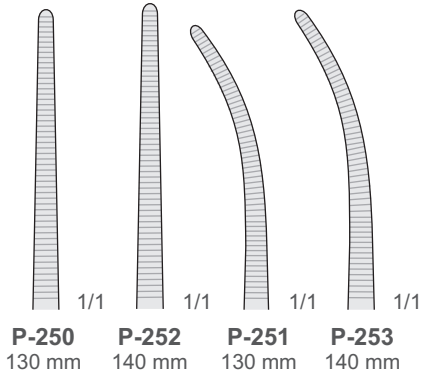
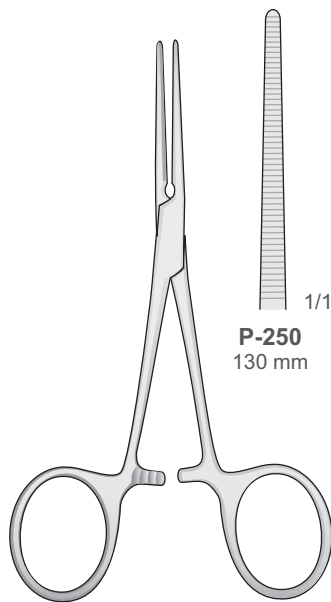

PEAN
P-250/P-253

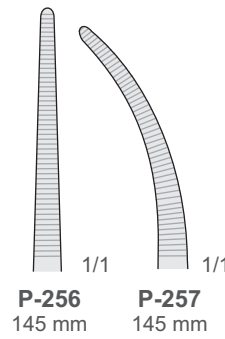
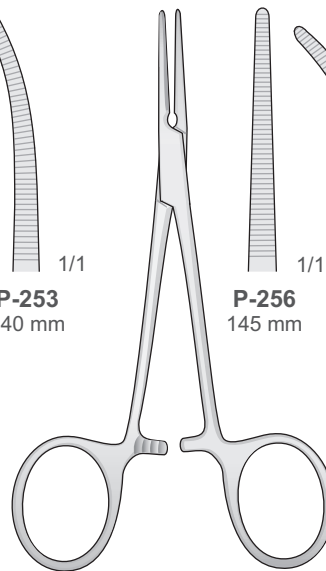

PEAN
P-256/P-257

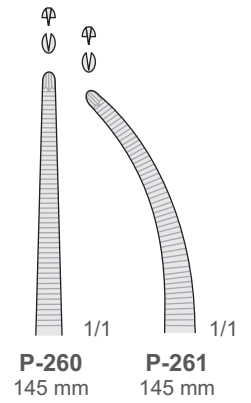
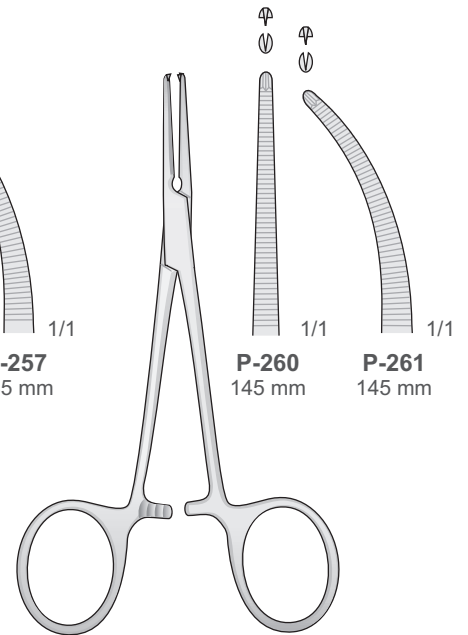

KOCHER
P-260/P-261

**HEMOSTATS
GRASPING**

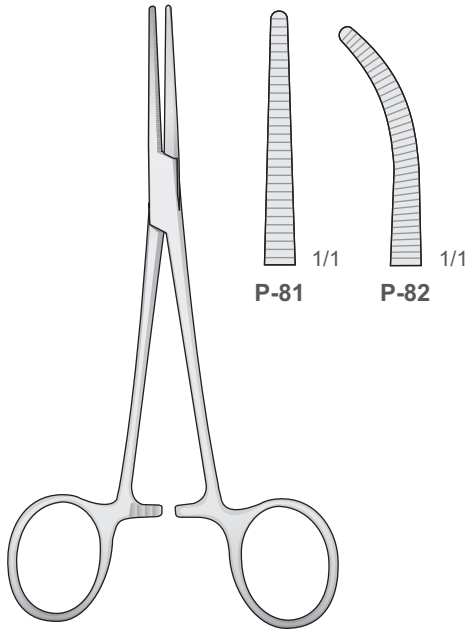

CRILE
 P-81/P-82
 140 mm

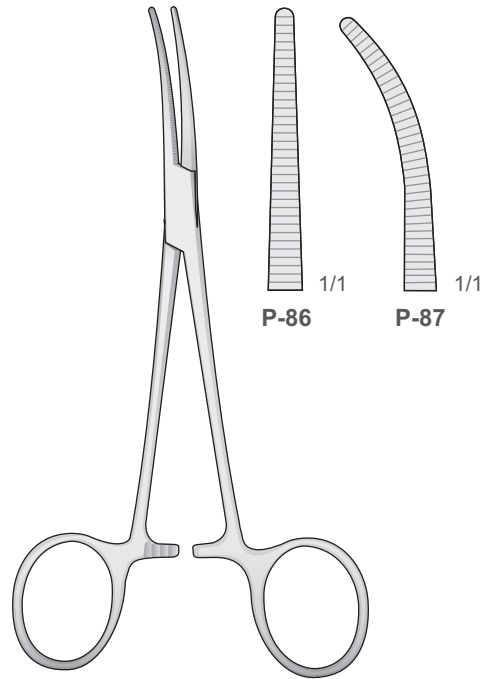

CRILE
 P-86/P-87
 160 mm

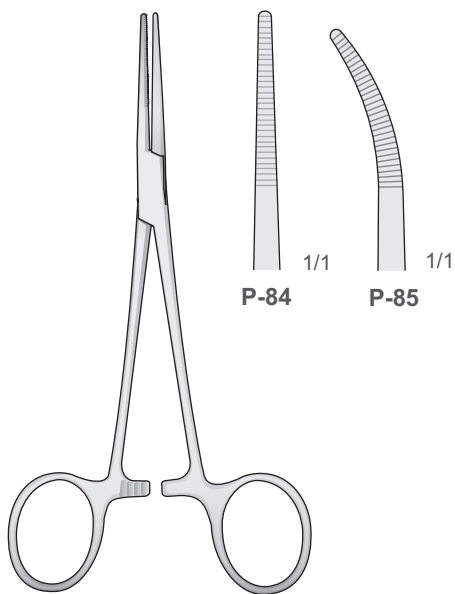

KELLY
 P-84/P-85
 140 mm

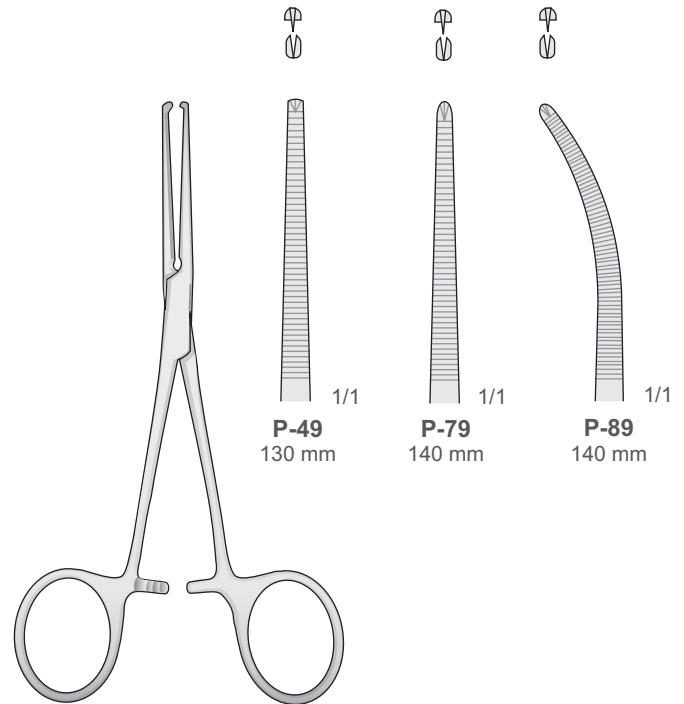

KOCHER
 P-49/P-89

Arterienklemmen
 Hemostatic Forceps
 Pinze emostatische
 Pinzas hemostáticas
 Pincas hémostatiques

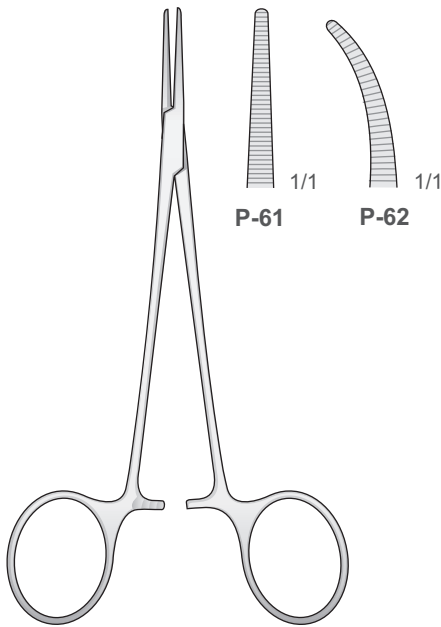

LERICHE
P-61/P-62
 150 mm

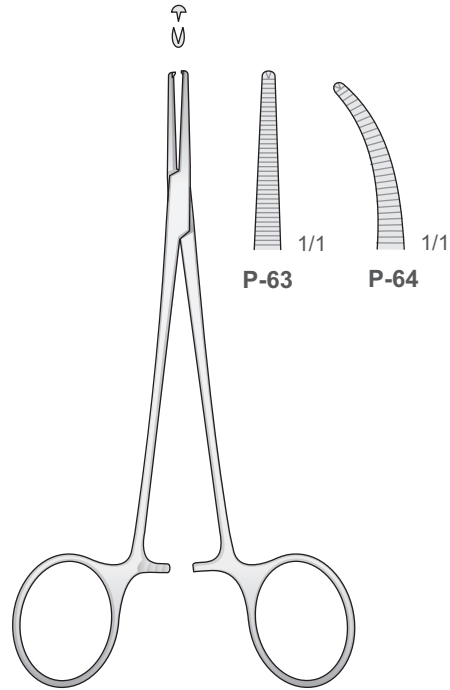

LERICHE
P-63/P-64
 150 mm

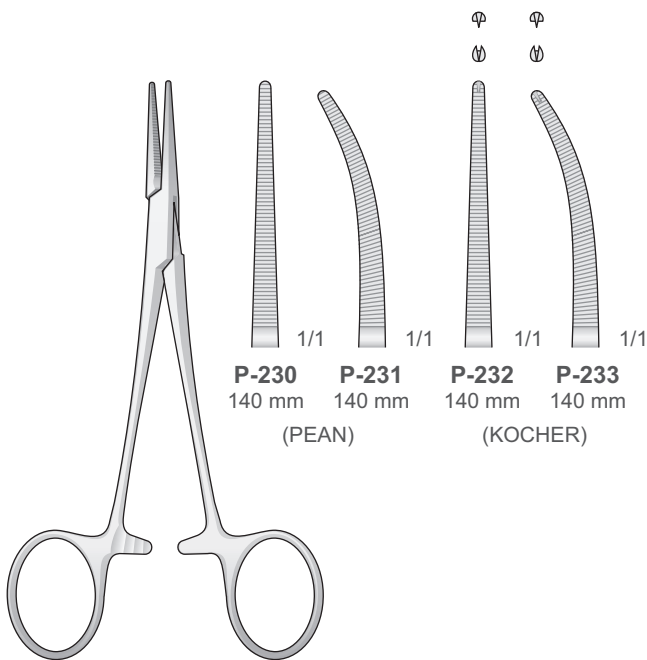

BABY-CRILE
P-230/P-233
 140 mm

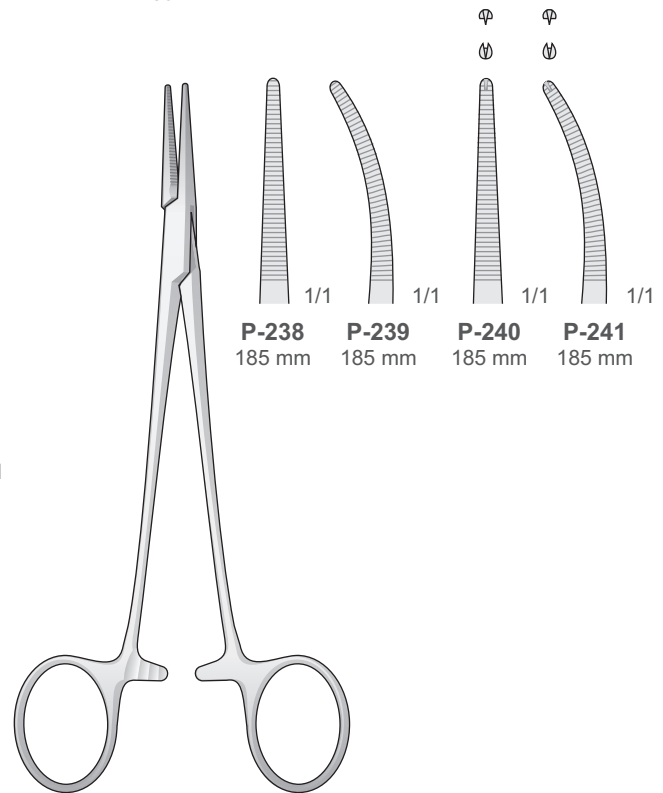

HALSTED
P-238/P-241
 185 mm

HEMOSTATS
 GRASPING

Tissue Grasping Forceps

Gewebefasszangen
Tissue Grasping Forceps
Pinze per tessuti
Pinzas para tejidos
Pincas pour tissus

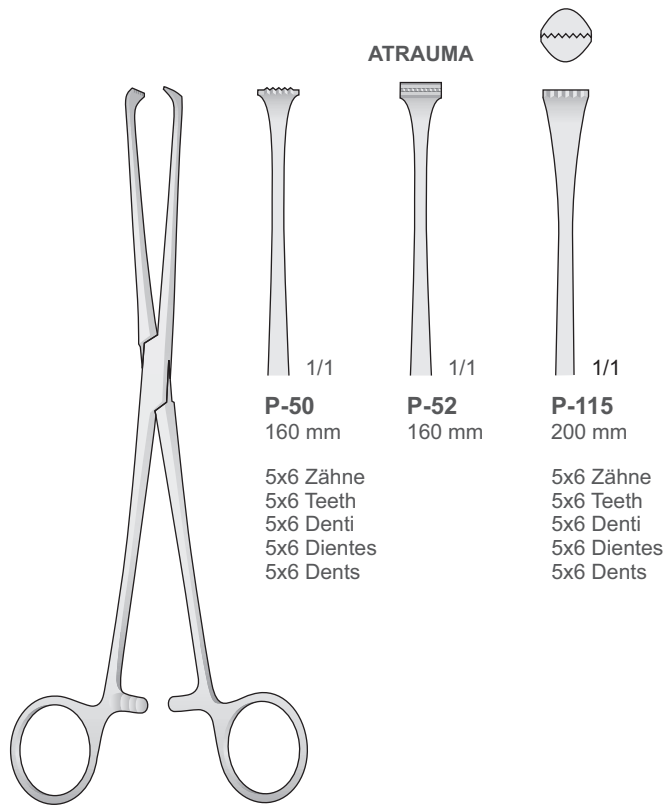

ALLIS
P-50/P-52

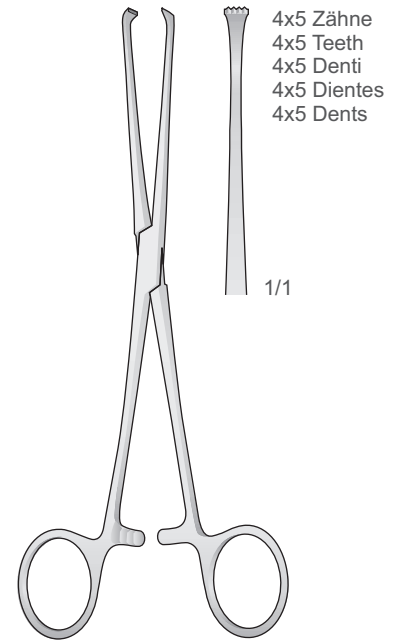

BABY-ALLIS
P-100
130 mm

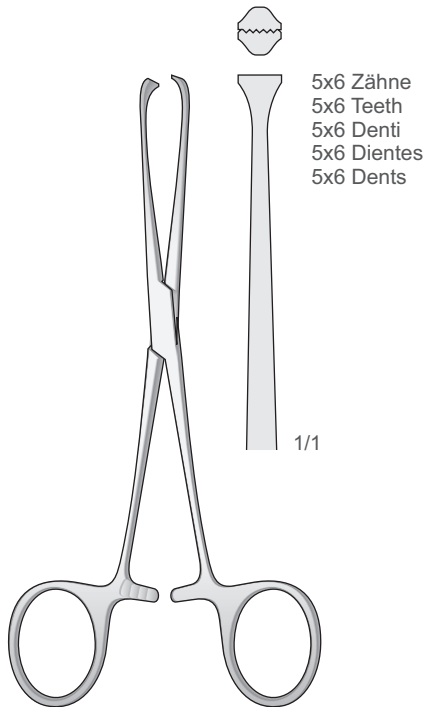

BOYS-ALLIS
P-129
150 mm

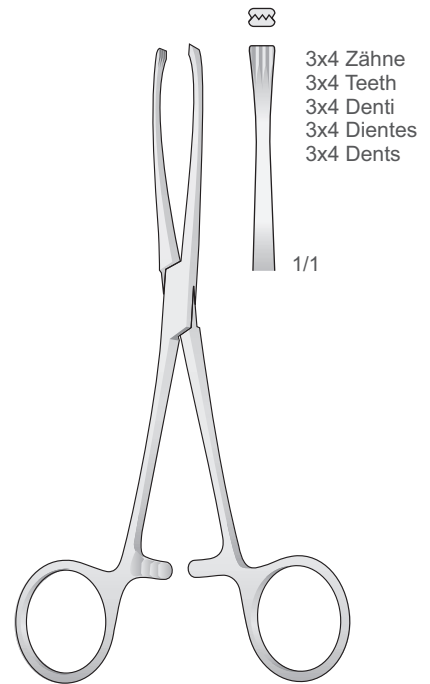

JUDD-ALLIS
P-324
155 mm

• Retractors

177 | Retractors

**188 | Mouth Gags and
Tongue Depressors**

196 | Mouth Props



RETRACTORS

Wundhaken
 Retractors
 Divaricatori
 Separadores
 Écarteurs

Retractors

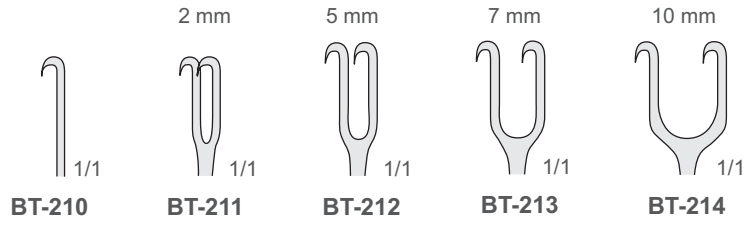
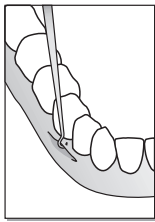

JOSEPH
BT-210/BT-214
 160 mm

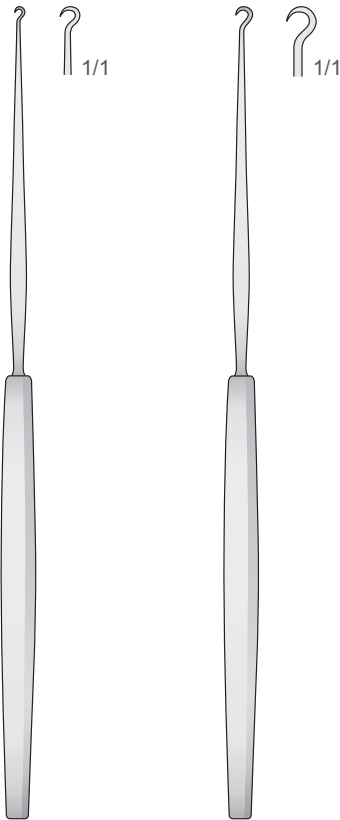

GILLIES
BT-15
 180 mm

GILLIES
BT-16
 180 mm



MINI-LANGENBECK
BT-186/BT-189
 160 mm

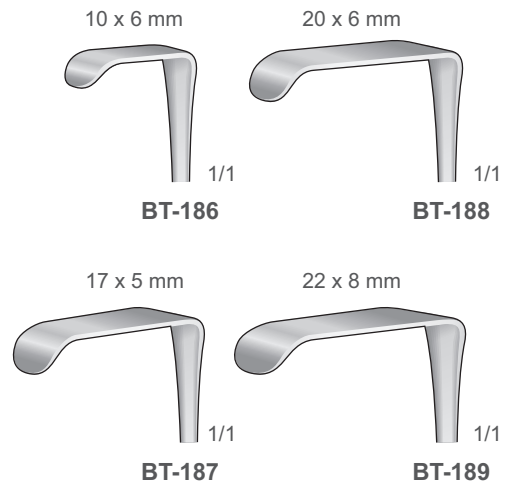

RETRACTORS

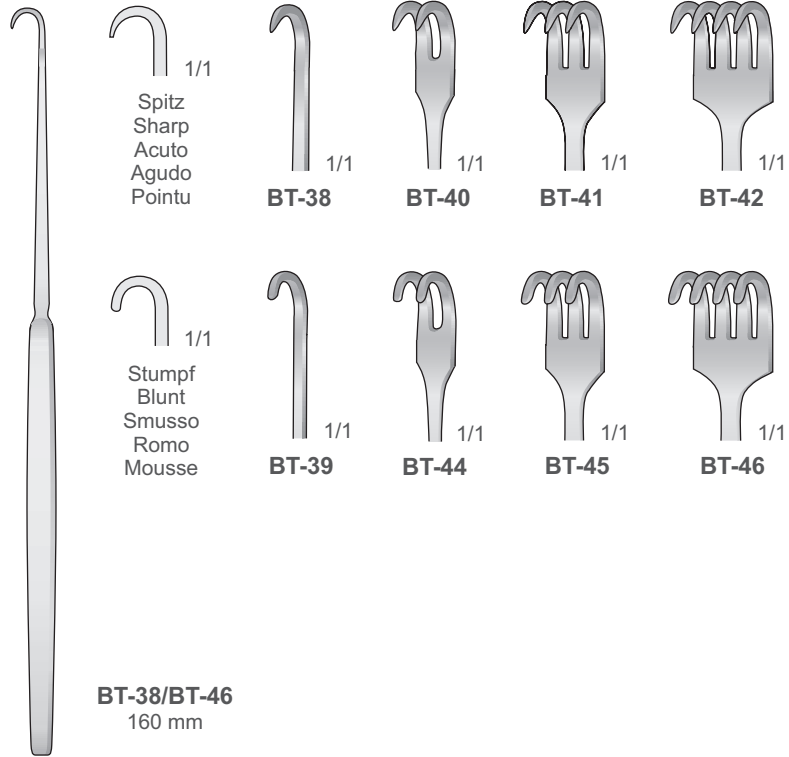

Feine wundhaken flexibel-spitz
Delicate retractors flexible-sharp
Divaricatori delicati flessibili-acuti
Separadores finos flexibles-agudos
Écarteurs fins pointu flexible

Feine wundhaken flexibel-stumpf
Delicate retractors flexible-blunt
Divaricatori delicati flessibili-smussi
Separadores finos flexibles-romos
Écarteurs fins mousse flexible

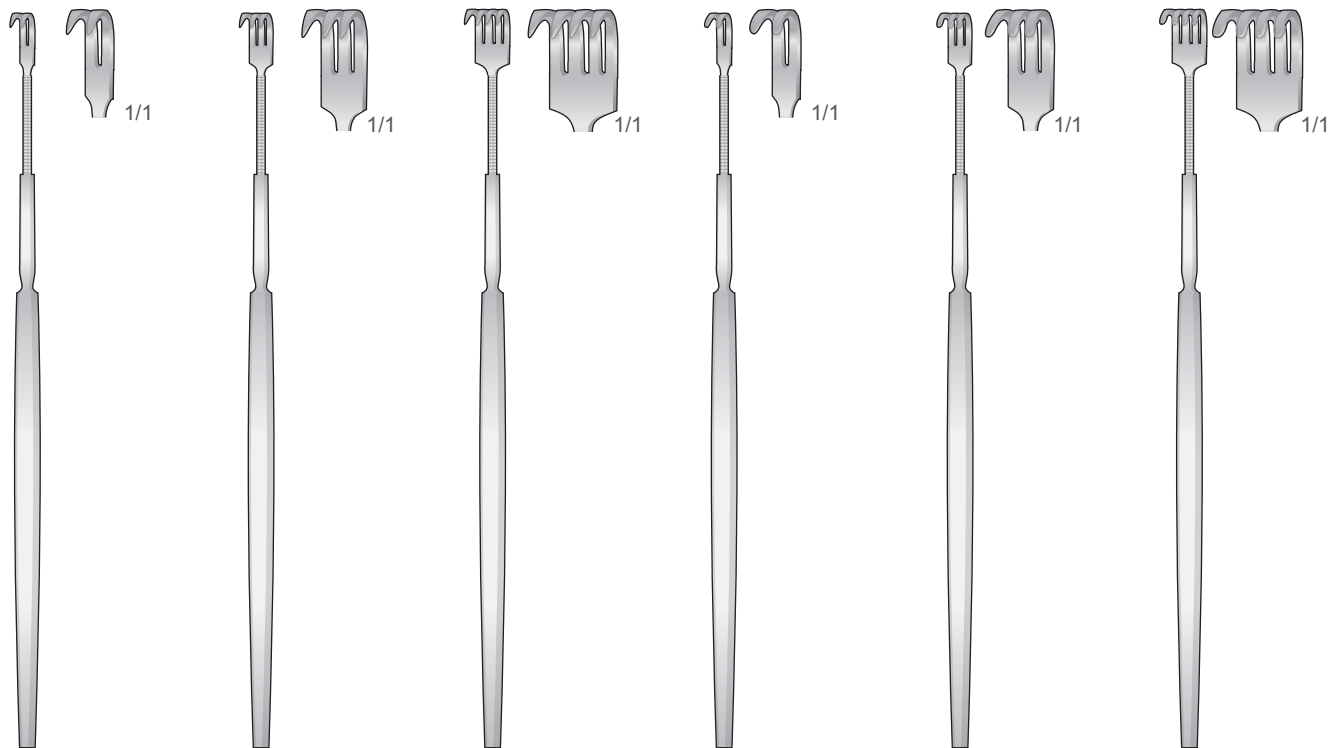

BT-50
150 mm

BT-51
150 mm

BT-52
150 mm

BT-54
150 mm

BT-55
150 mm

BT-56
150 mm

Wundhaken
 Retractors
 Divaricatori
 Separadores
 Écarteurs

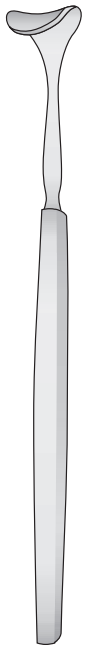

DESMARRES
BT-70/BT-77
 140 mm

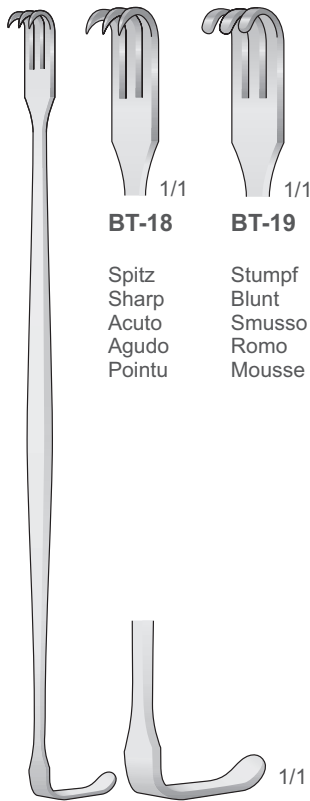
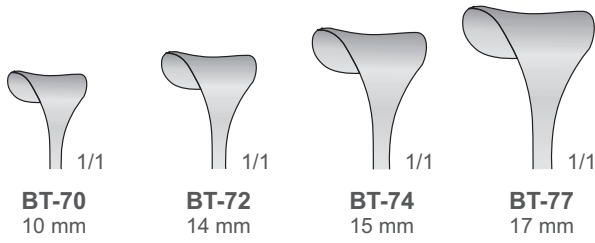

SEAN-MILLER
BT-18/BT-19
 160 mm

BT-18
 Spitz
 Sharp
 Acuto
 Agudo
 Pointu

BT-19
 Stumpf
 Blunt
 Smusso
 Romo
 Mousse

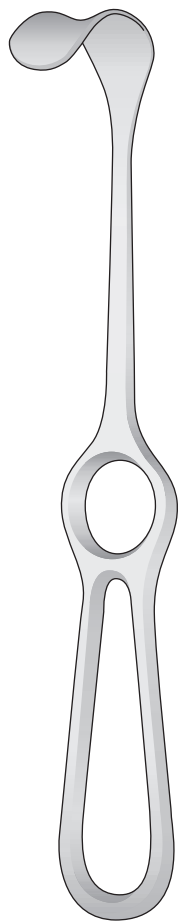

KOCHER
BT-117/BT-118
 205 mm

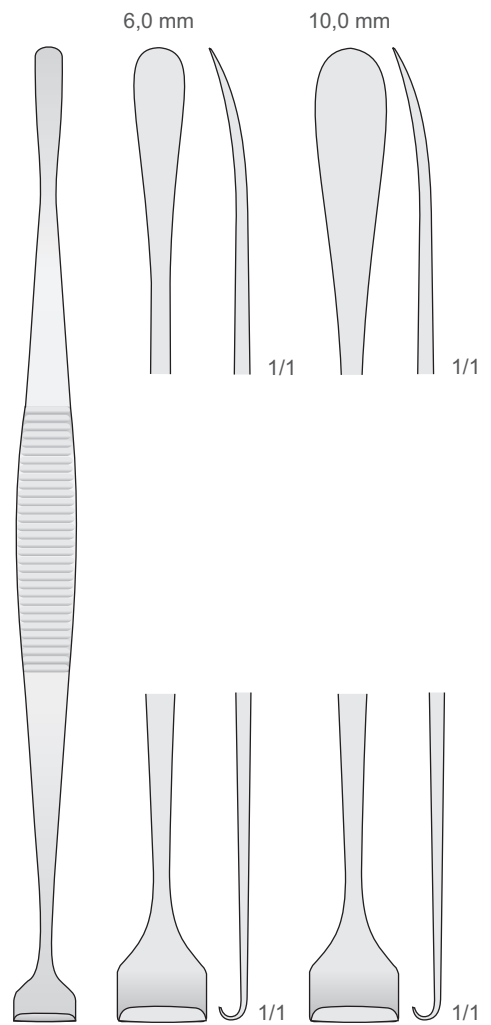
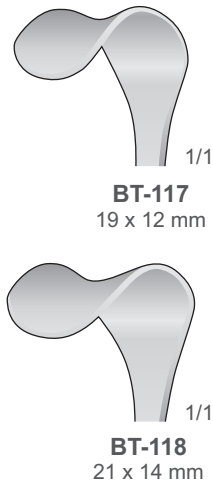

HURD
BT-1/BT-2
 220 mm

12 mm

12 mm

6,0 mm

10,0 mm

RETRACTORS

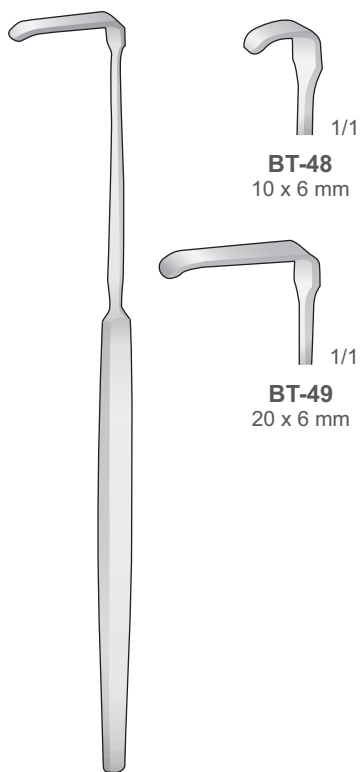

SENN GREEN
BT-48/BT-49
160 mm

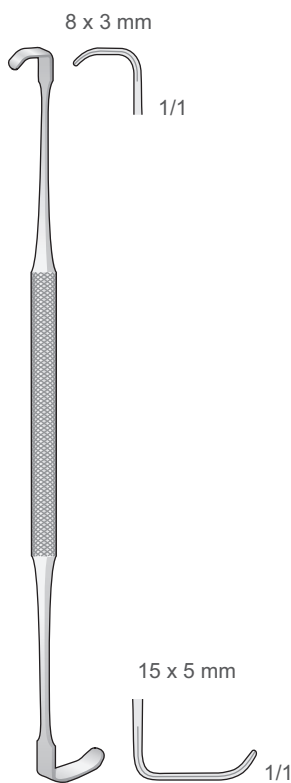

RAGNELL
BT-27
140 mm

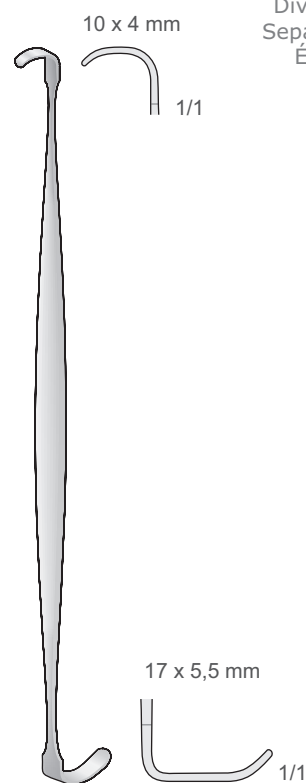

RAGNELL-DAVIS
BT-26
140 mm

RETRACTORS

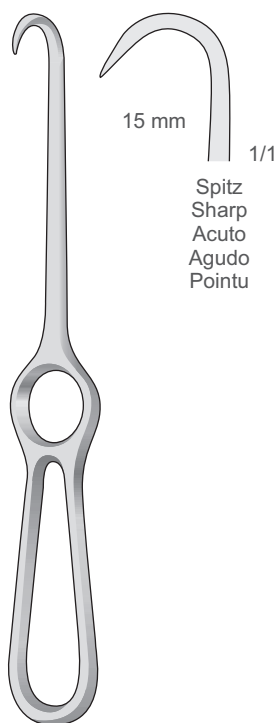

KOCHER
BT-139
205 mm

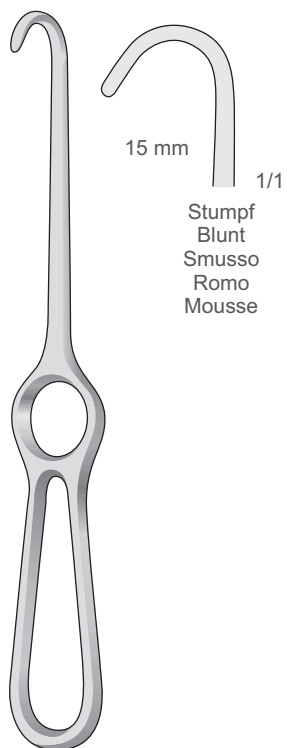

KOCHER
BT-140
220 mm



LAHEY
BT-109
195 mm

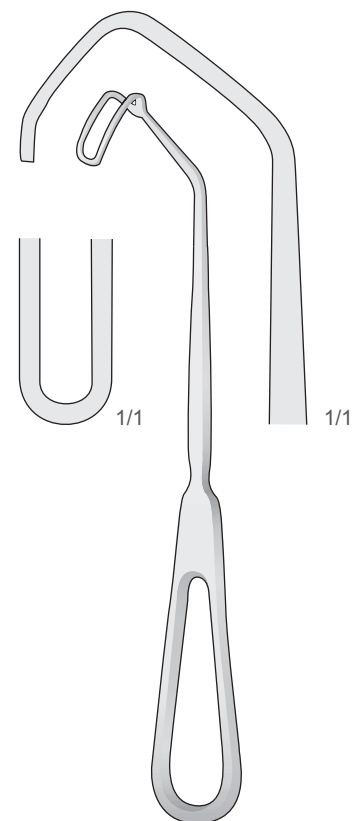

CUSHING
BT-29
200 mm

Wundhaken
Retractors
Divaricatori
Separadores
Écarteurs

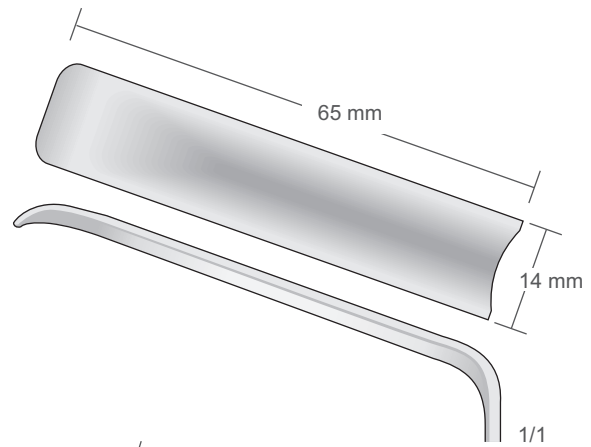

BT-265

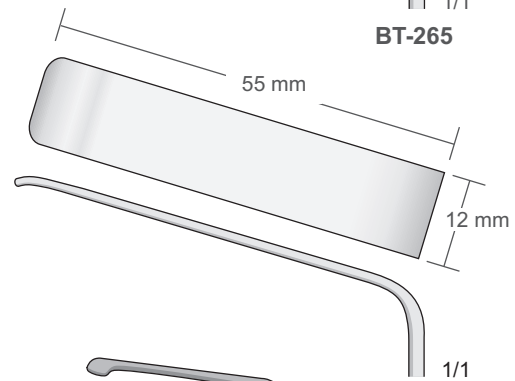

BT-264

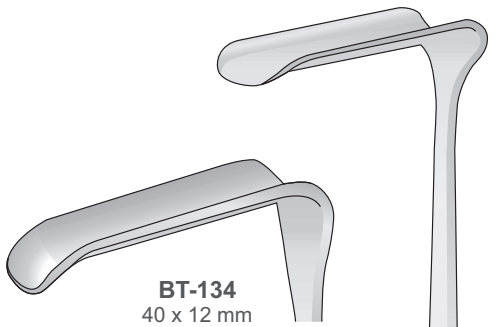

BT-134
40 x 12 mm

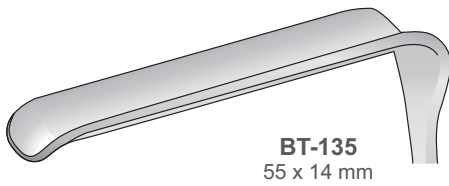

BT-135
55 x 14 mm

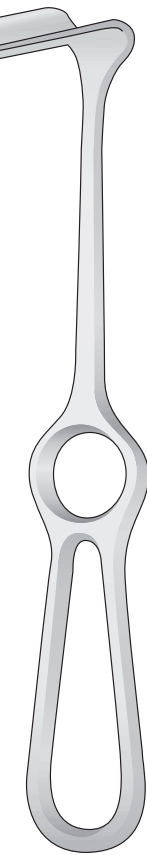

DOCKHORN
BT-134/BT-135
210 mm

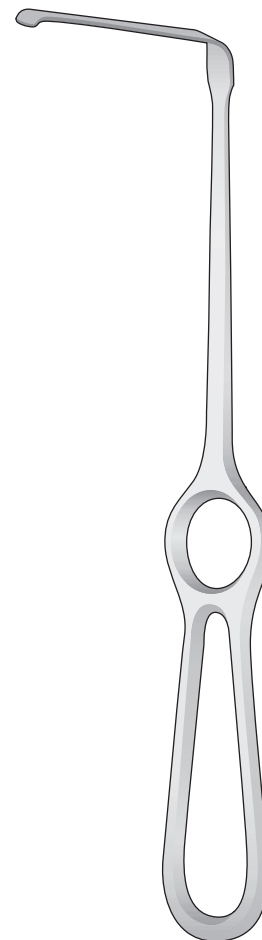

BT-264/BT-265
235 mm

RETRACTORS

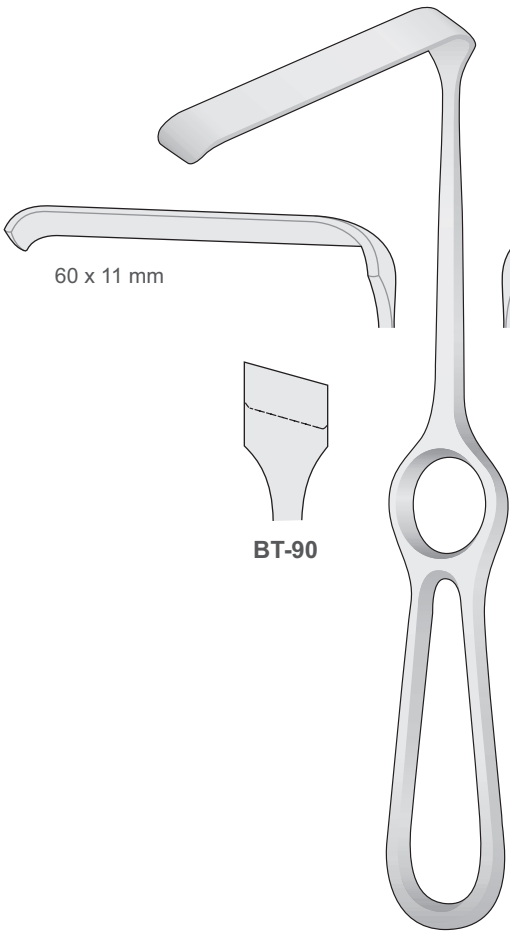

KIRSCH
BT-90/BT-91
210 mm

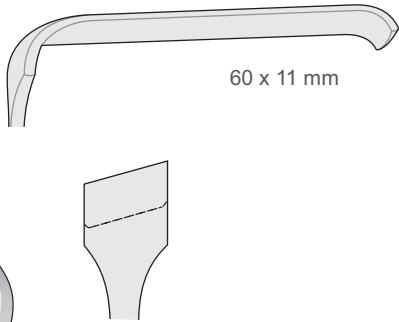

MIDDENDORPF
BT-80/BT-82
225 mm

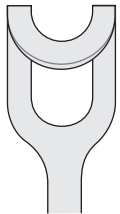

BT-80
15 x 15 mm

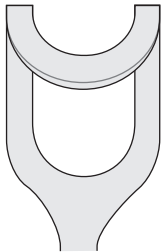

BT-81
20 x 22 mm

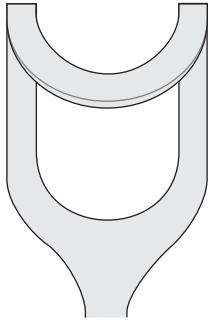

BT-82
28 x 28 mm

Wundhaken
Retractors
Divaricatori
Separadores
Écarteurs

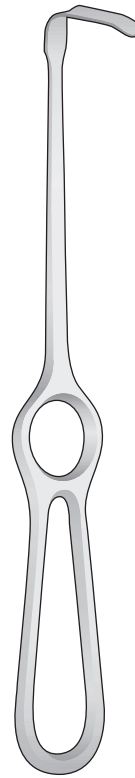
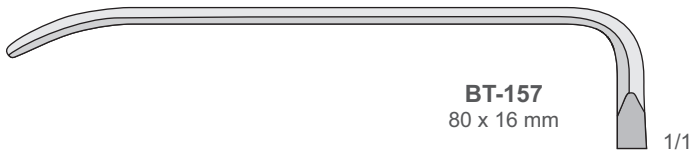
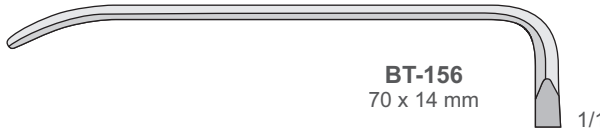
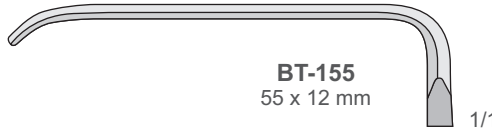
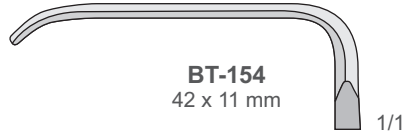

OBWEGESER
BT-152/BT-157
220 mm

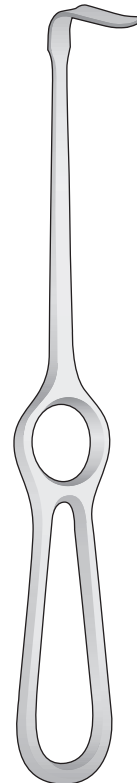
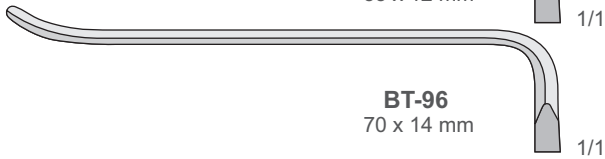
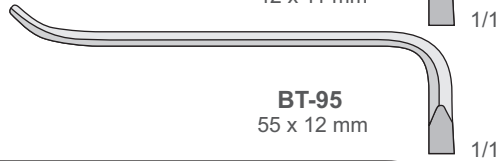
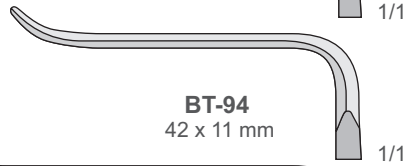

OBWEGESER
BT-92/BT-100
220 mm

RETRACTORS

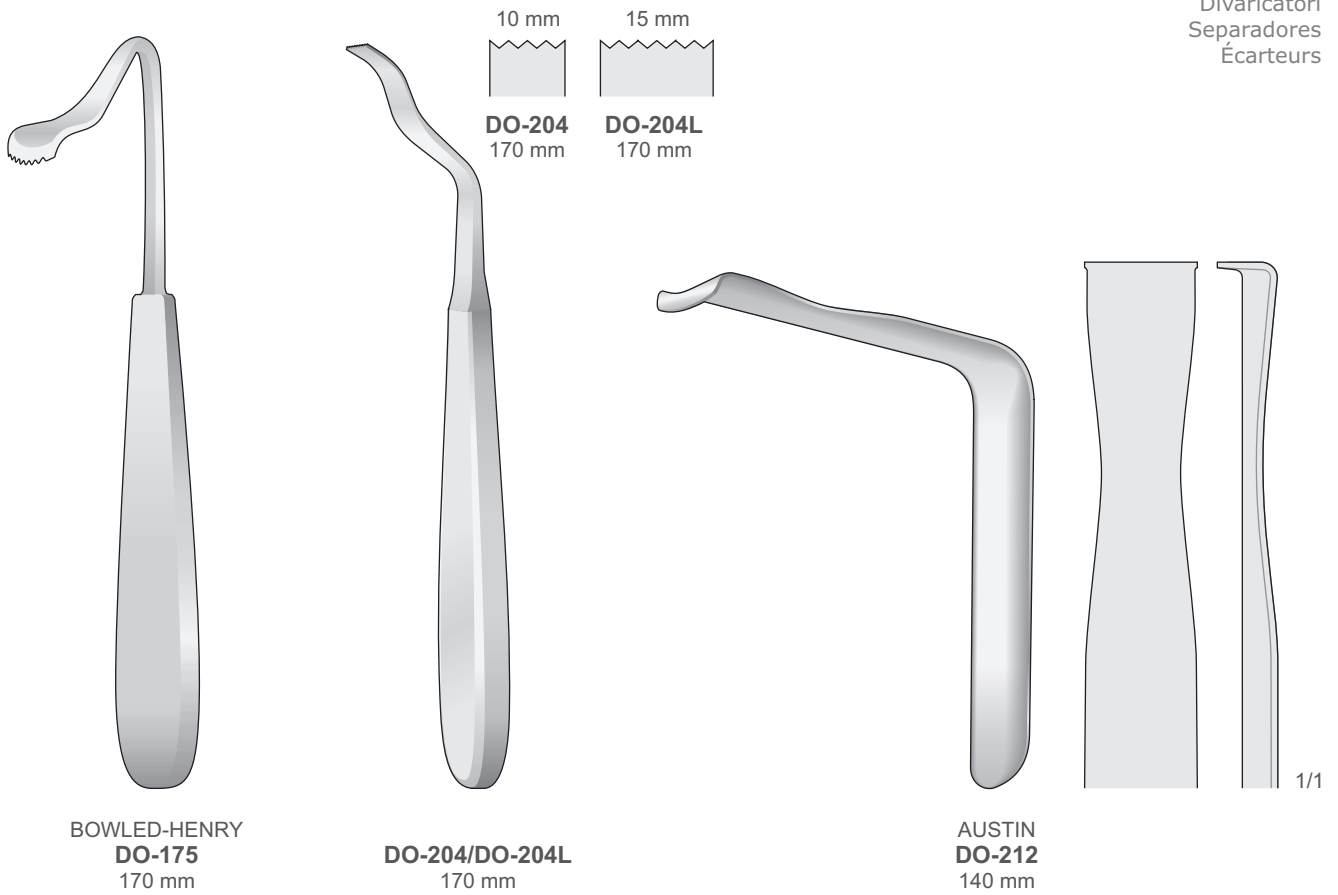

RETRACTORS

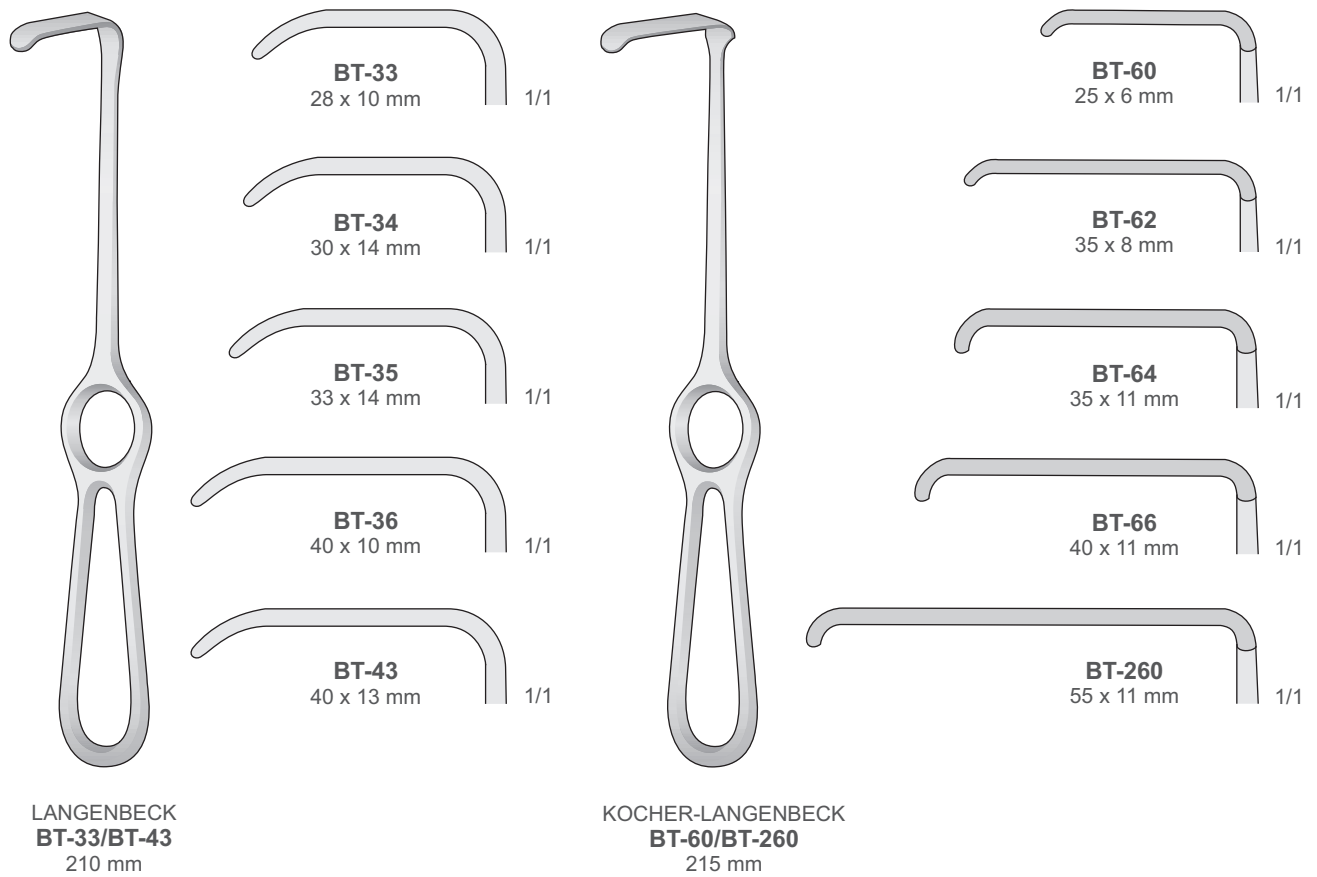

Rostfrei - Stainless Steel
 Acciaio - Acero - Acer

Biegsam - Malleable
 Malleabili - Maleables
 Souples

OM-85
 Komplettsset mit 3 Spatel
 Set complete with 3 spatulas
 Set completo con 3 spatole
 Set completos con 3 espátulas
 Set complete avec 3 spatules
OM-80 + OM-81 + OM-82

Schwarz Verchromt
 Black anodized
 Cromato nero
 Cromado en negro
 Chromé noir

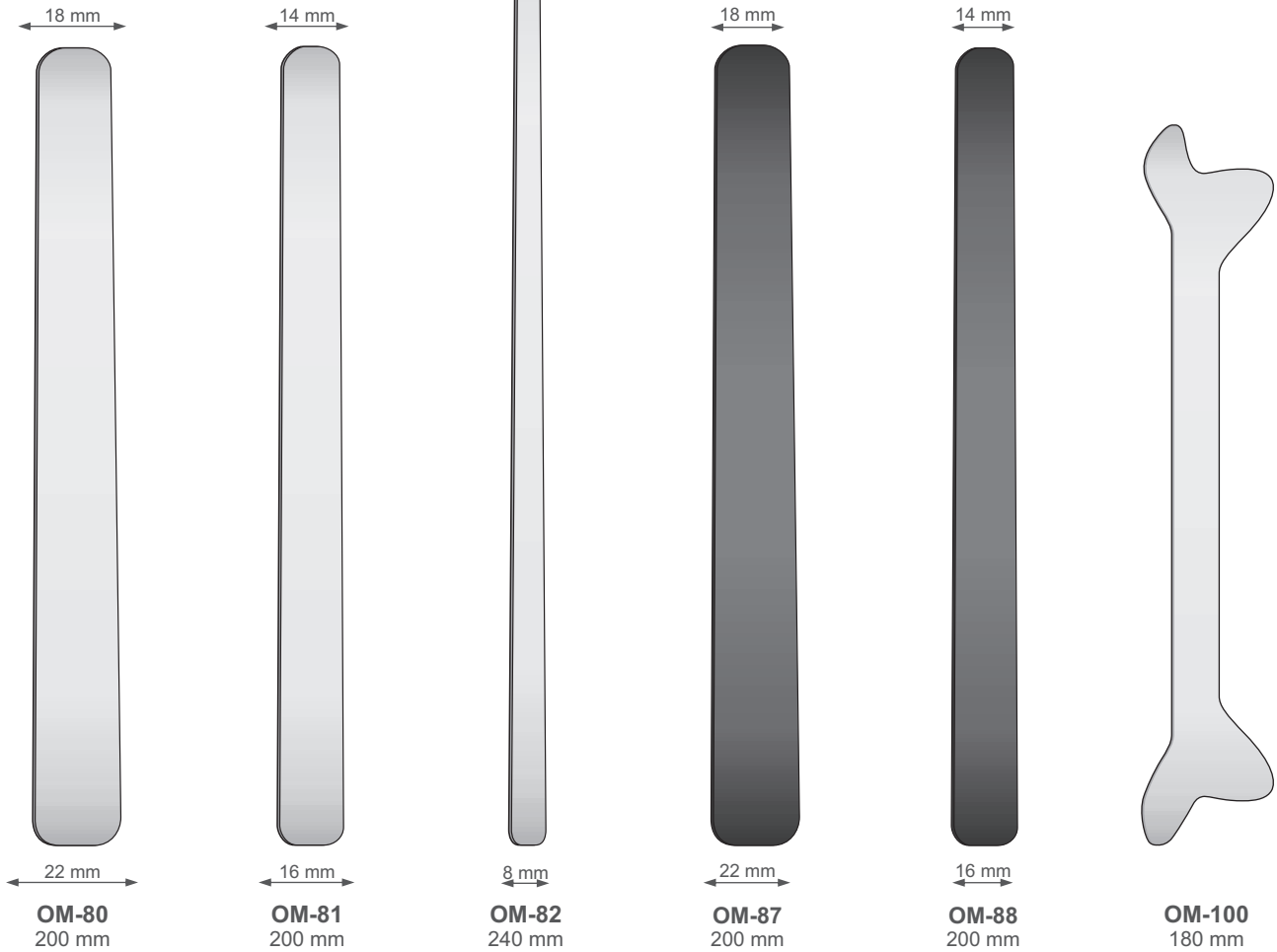

RETRACTORS

Zungendrucker
 Tongue Depressors
 Abbassalingua
 Bajalengua
 Abaisse langue

Kinnhalter
 Chin Holder
 Divaricatore per mento
 Separador para mentón
 Écarteur pour menton

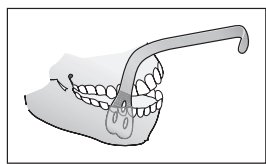

RETRACTORS

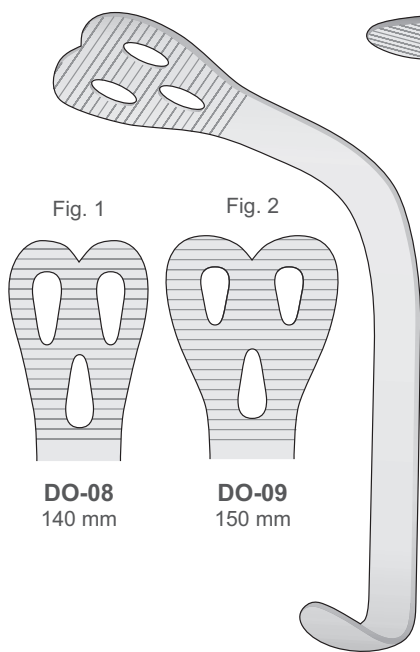

Fig. 1

Fig. 2

DO-08
 140 mm

DO-09
 150 mm

WIEDER
DO-08/DO-09

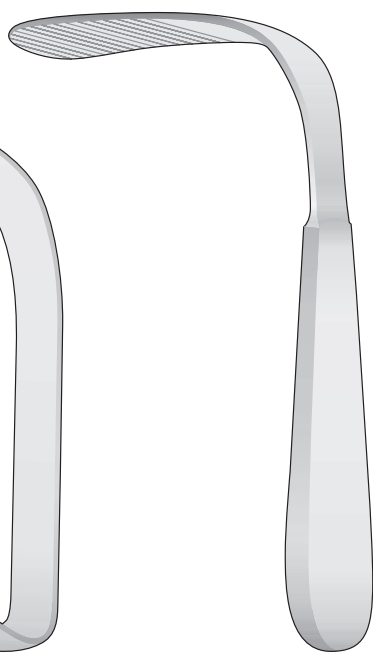

TOBOLD
OM-08
 145 mm

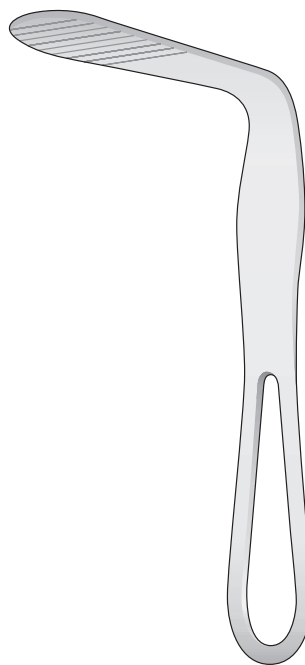

HARTMANN
OM-06
 150 mm

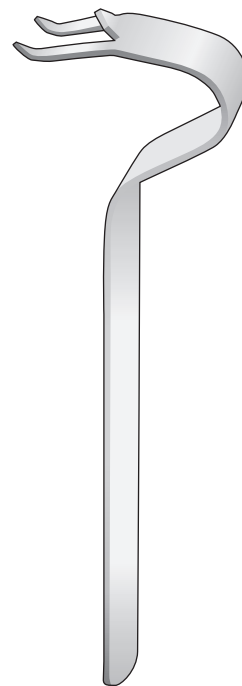

OBWEGESER
DO-40
 155 mm

Ramushaken für Spina Nasalis
Ramus Retractor for nasal spine
Divaricatori per spina nasalis
Separadores para spina nasalis
Écarteurs pour spina nasalis

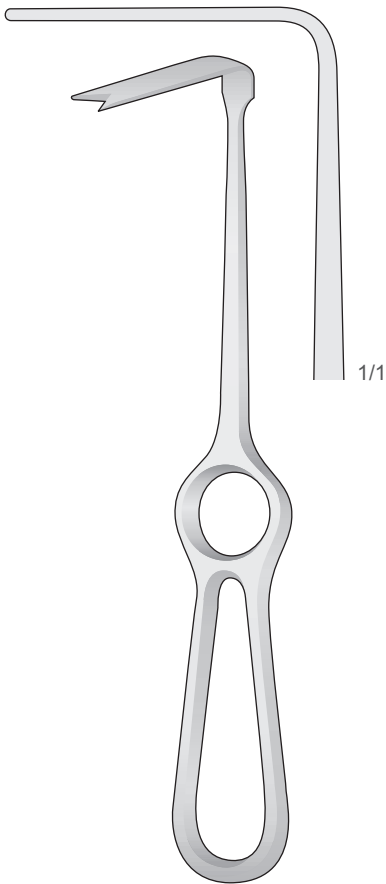
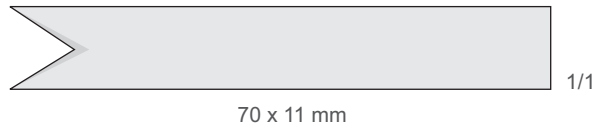

OBWEGESER
BT-67
220 mm

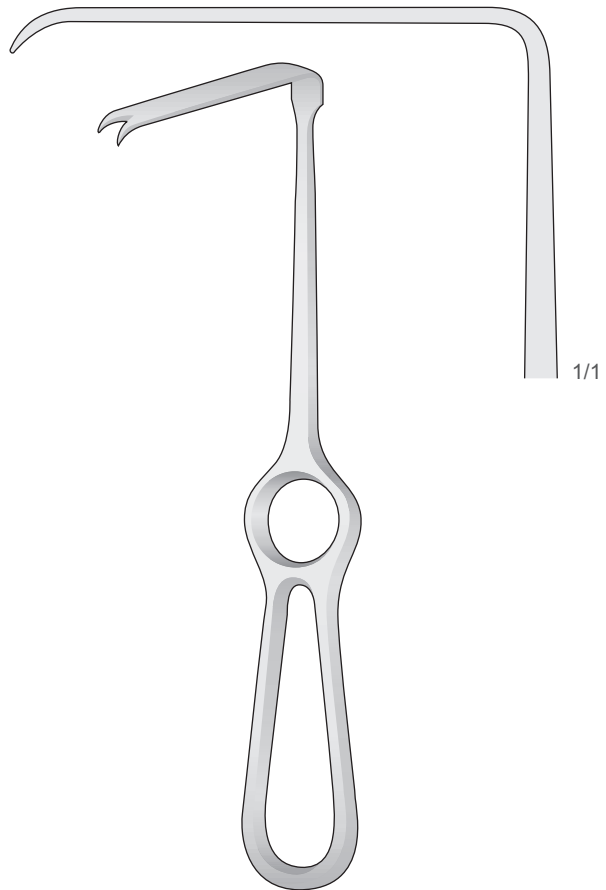

OBWEGESER
BT-68
220 mm

Mouth Gags and Tongue Depressors

Mundsperrer
Mouth gags
Apribocca
Abrebocas
Écarteur buccal

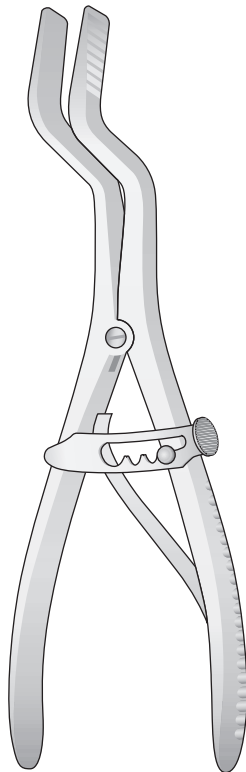

ROSER KÖNIG
OM-60
185 mm

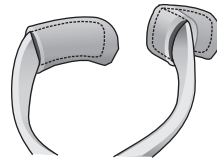

Paar Einsätze aus Silikon für:
Pair of silicone inserts for:
Coppia di inserti in silicone per:
Pareja de inserto de silicone para:
Paire de inserts en silicón pour:

OM-40 - OM-41

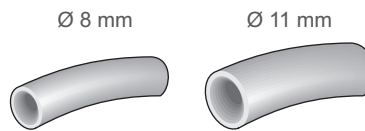

OM-40R
30 mm

OM-41R
30 mm

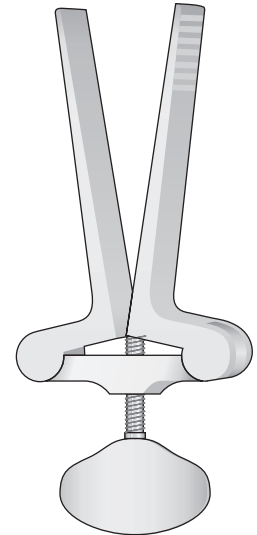

HEISTER
OM-62
135 mm

Für Erwachsene - For adults
Per adulti - Para adultos
Pour adultes

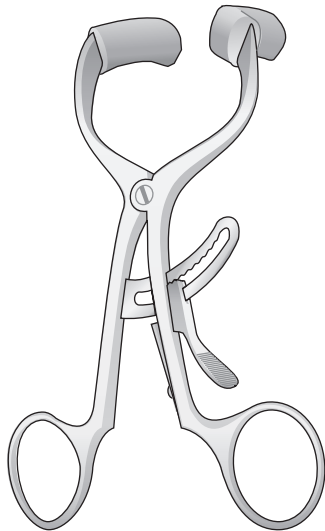

MOLT
DOYEN-JANSEN
OM-41
140 mm

Für Erwachsene - For adults
Per adulti - Para adultos
Pour adultes

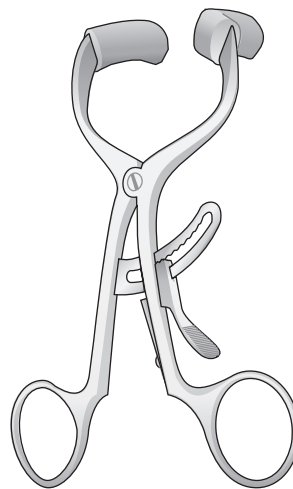

MOLT
DOYEN-COLLIN
OM-40
120 mm

Für Kinder
For children
Per bambini
Para niños
Pour enfants

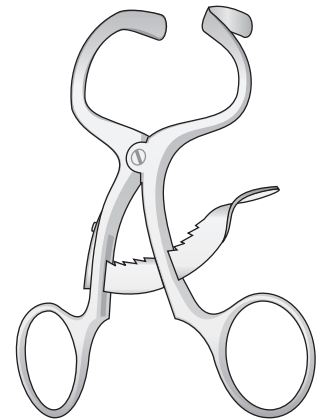

MOLT
OM-42
100 mm

Mundsperrer
 Mouth gags
 Apribocca
 Abrebocas
 Écarteur buccal

Abhalter für gesamten Ober-bzw. Unterkiefer
 Retractor for complete upper resp. Lower jaws
 Retrattore per arcata superiore e inferiore intera
 Separadores para quijadas enteras inferiores y superiores
 Écarteurs pour machoires complètes inférieures et supérieures

- OM-74** Fig. 0 100 x 95 mm
- OM-75** Fig. 1 115 x 105 mm
- OM-76** Fig. 2 115 x 110 mm
- OM-77** Fig. 3 125 x 115 mm

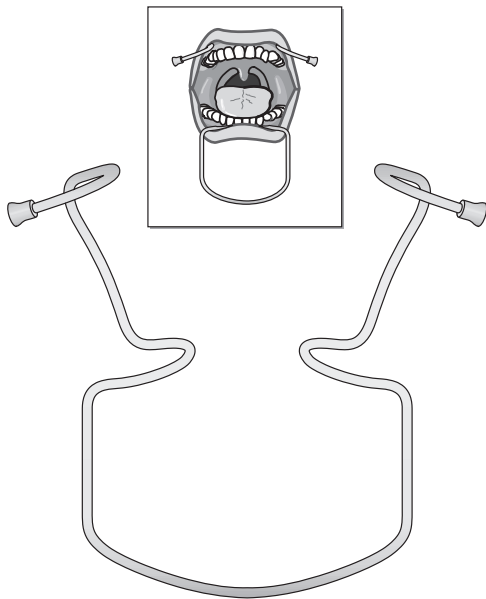

ORINGER
OM-74/OM-77

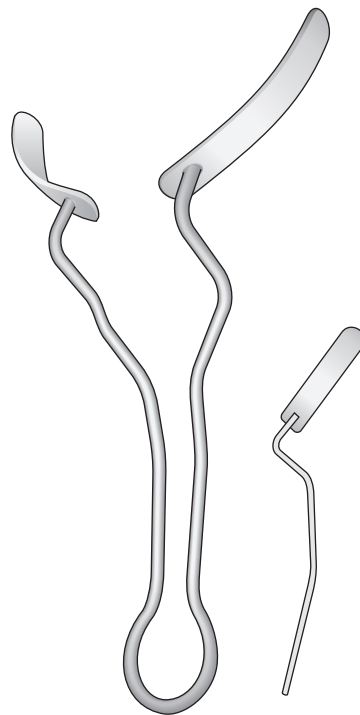

MATY
OM-97
 170 mm

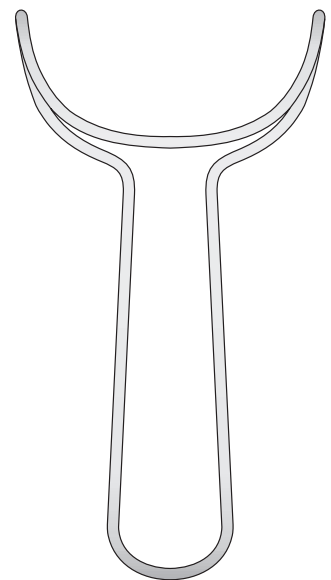

OM-90
 150 mm

RETRACTORS

BT-283
Set completo
Set complete
Komplettsset
Set complet
Set completo
BT-284 + BT-285 + BT-286

29 mm
26 mm
22 mm

28 mm
38 mm
44 mm

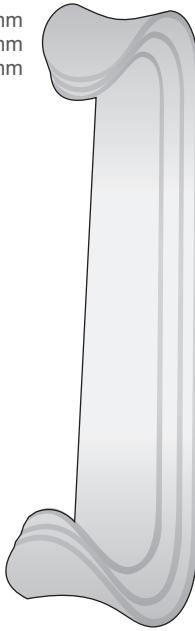

**ROUX
BT-283**
165 mm

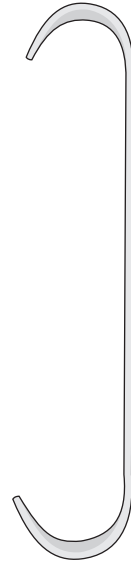

**ROUX
BT-284**
20x22 mm
25x28 mm



**ROUX
BT-285**
23x26 mm
29x38 mm

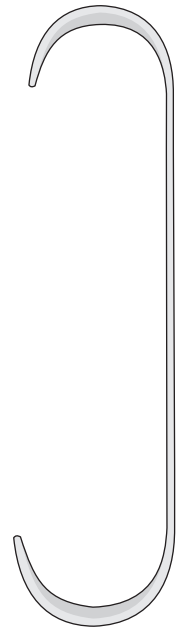

**ROUX
BT-286**
29x29 mm
34x44 mm

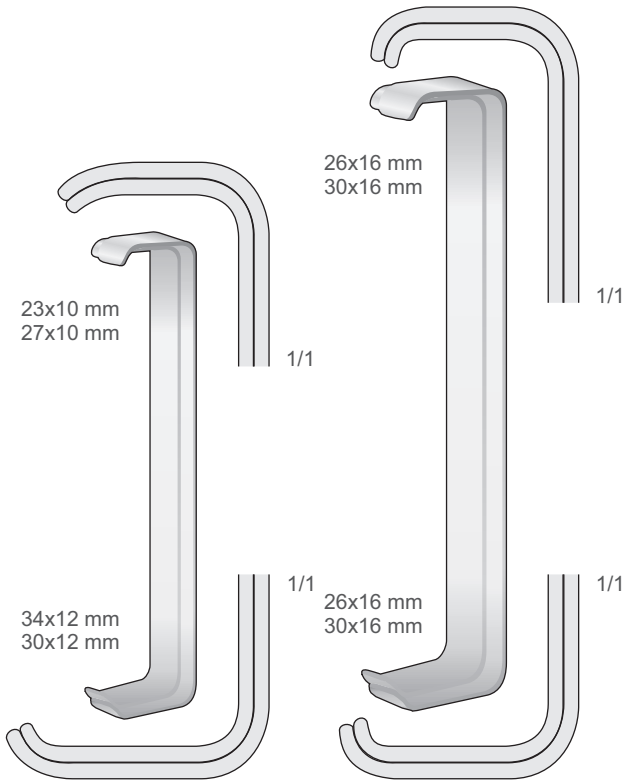

23x10 mm
27x10 mm

26x16 mm
30x16 mm

34x12 mm
30x12 mm

26x16 mm
30x16 mm

**FARABEUF
BT-20**
120 mm

**FARABEUF
BT-25**
150 mm

20x22 mm

23x26 mm

29x29 mm

**ROUX-MAGNUS
BT-287**
150 mm

**ROUX-MAGNUS
BT-288**
160 mm

**ROUX-MAGNUS
BT-289**
170 mm

Wangenhalter
 Cheek Retractors
 Divaricatori per guance
 Separador para mejillas
 Écarteurs des joues

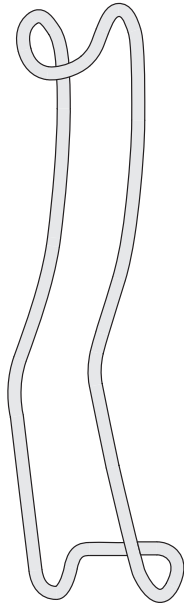

STERNBERG
OM-50
 160 mm

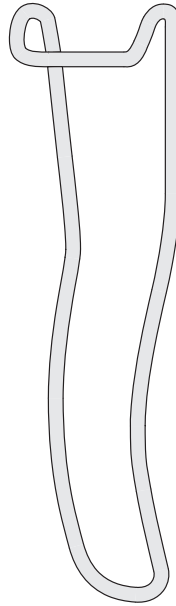

STERNBERG
OM-52
 160 mm

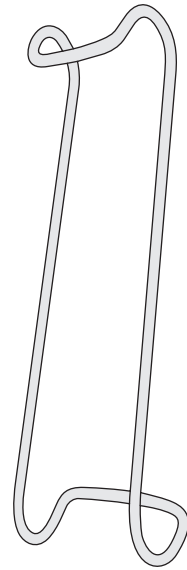

COLUMBIA
OM-67
 140 mm

Schwarz Verchromt
 Black anodized
 Cromato nero
 Cromado en negro
 Chromé noir

**NEW
 BLACK**

RETRACTORS

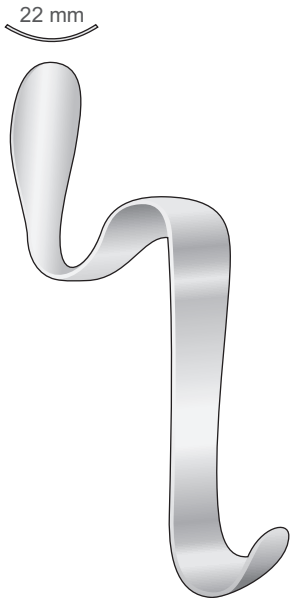

BISHOP
OM-61
 130 mm



MINNESOTA
OM-55
 140 mm

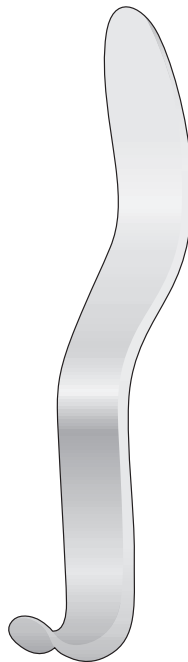

CAWOOD-MINNESOTA
OM-66
 160 mm

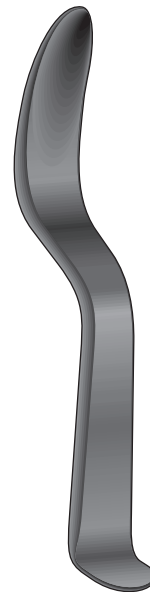

MINNESOTA
OM-55B
 140 mm

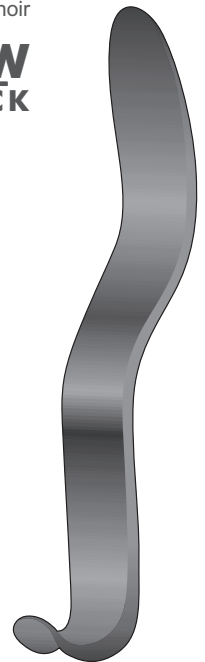

CAWOOD-MINNESOTA
OM-66B
 160 mm

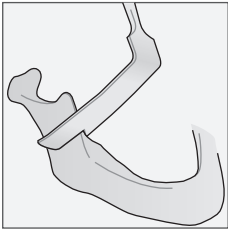

Ramus Retraktoren Recht
Ramus Retractor Right
Retrattore Ramus destro
Separadores Ramus derecho
Écarteur Ramus droites

Ramus Retraktoren Link
Ramus Retractor Left
Retrattore Ramus sinistro
Separadores Ramus izquierdo
Écarteur Ramus gauches

RETRACTORS

8 mm

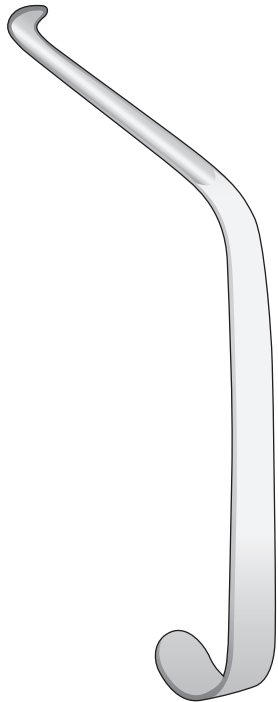

OBWEGESER
DO-41
165 mm

10 mm

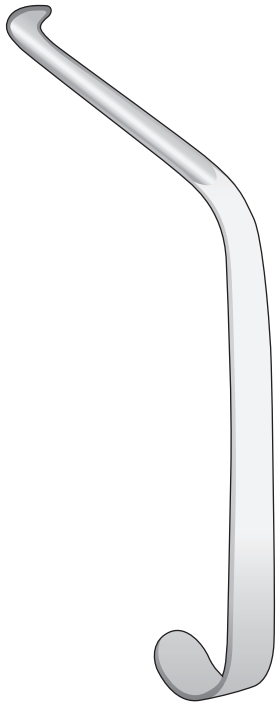

OBWEGESER
DO-142
165 mm



MISCH
BT-158
210 mm

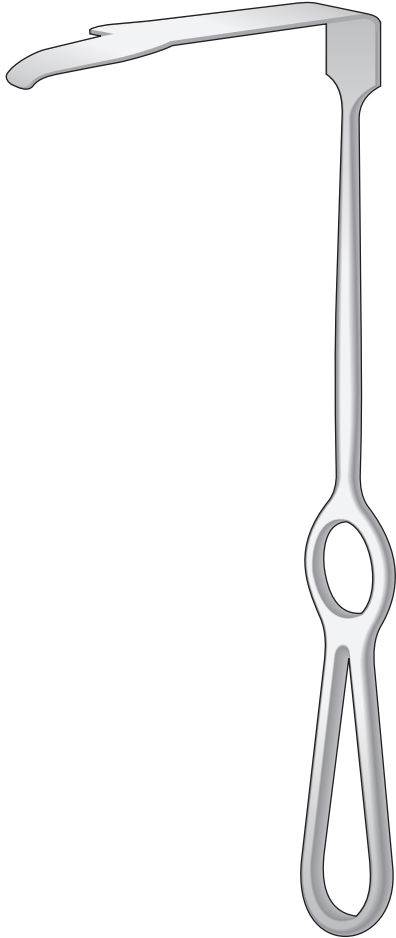

MISCH
BT-159
210 mm

Mundsperrer
 Mouth Gags
 Apribocca
 Abrebocas
 Écarteur buccal

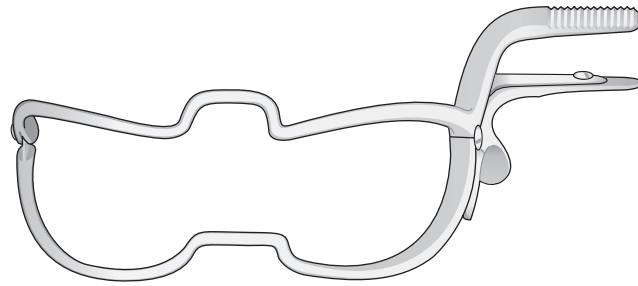

WHITEHEAD-JENNINGS

- OM-136** 90 mm
- OM-137** 110 mm
- OM-138** 130 mm
- OM-139** 150 mm

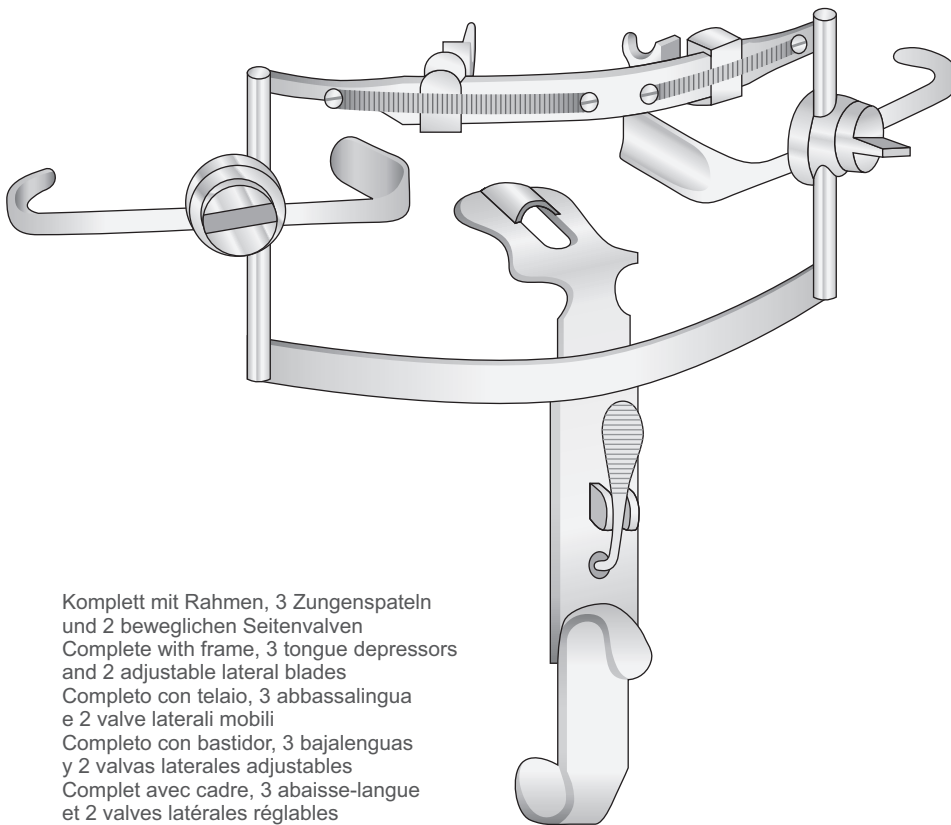

Komplett mit Rahmen, 3 Zungenspateln
 und 2 beweglichen Seitenvallen
 Complete with frame, 3 tongue depressors
 and 2 adjustable lateral blades
 Completo con telaio, 3 abbassalingua
 e 2 valve laterali mobili
 Completo con bastidor, 3 bajalenguas
 y 2 valvas laterales ajustables
 Complet avec cadre, 3 abaisse-langue
 et 2 valves latérales réglables

DINGMANN
OM-110
 Set completo

DINGMANN

Zungenspatel
 Tongue depressor
 Abbassalingua
 Bajalengua
 Abaisse langue

Fig. 1

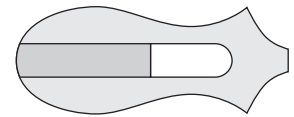

OM-112
 65 x 25 mm

Fig. 2

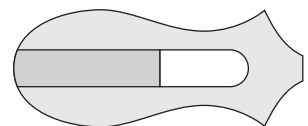

OM-113
 70 x 29 mm

Fig. 3

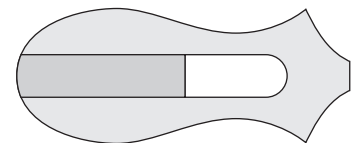

OM-114
 80 x 32 mm

RETRACTORS

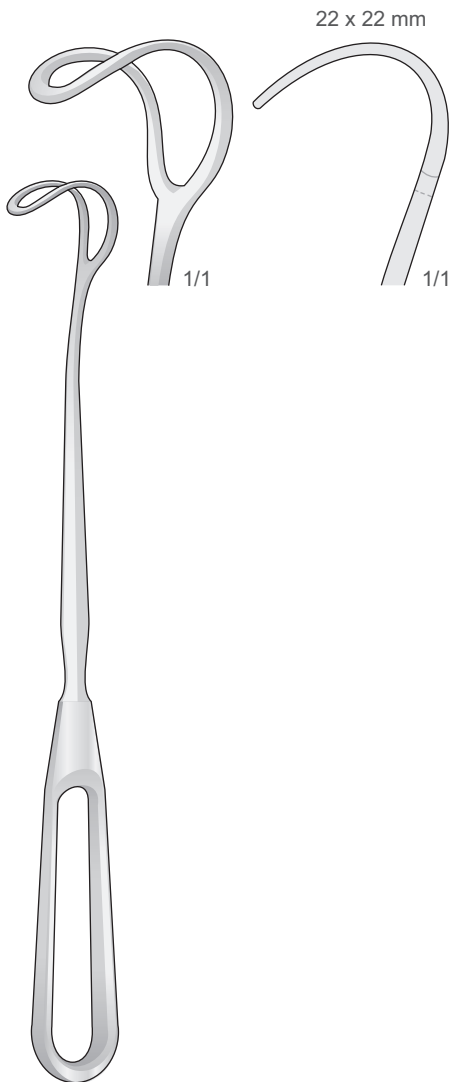

GREENE
BT-131
225 mm

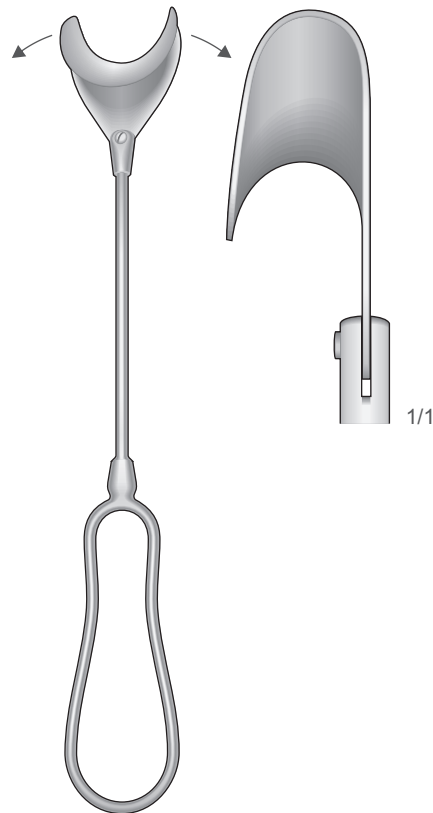

BT-132
200 mm

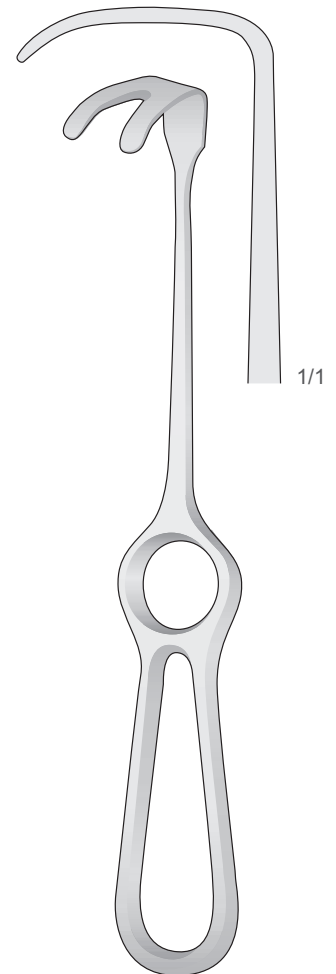

WASSMUND
BT-69
220 mm

Zungenspatel - Zungenzangen
 Tongue Depressors - Tongue Holding Forceps
 Abbassalingua - Pinze tiralingua
 Bajalenguas - Pinzas tira-lengua
 Abaisse langues - Pincés tire-langue

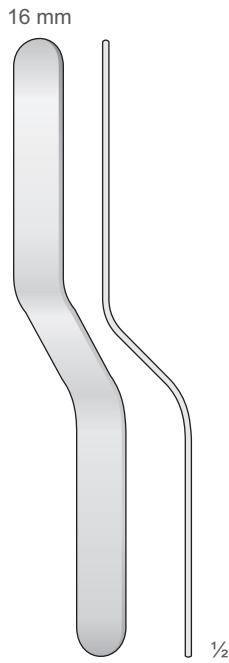

OM-07
145 mm

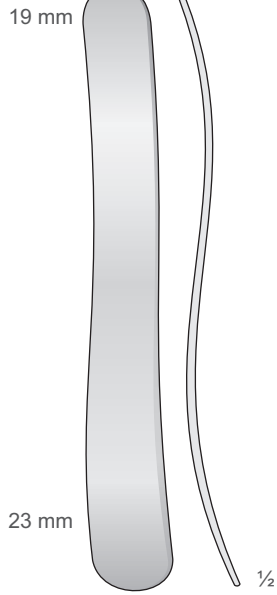

KROENIG OM-16
150 mm

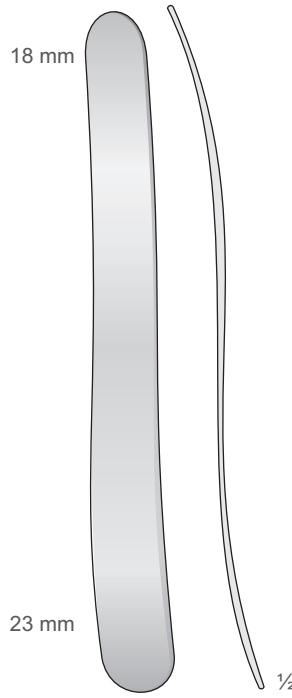

BUCHWALD OM-18
180 mm

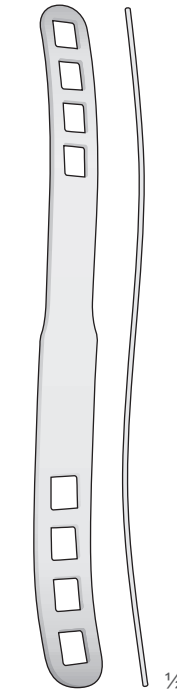

BRUENINGS OM-04
190 mm

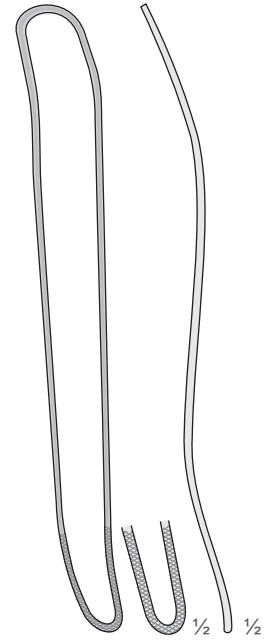

FRENZEL OM-19
165 mm

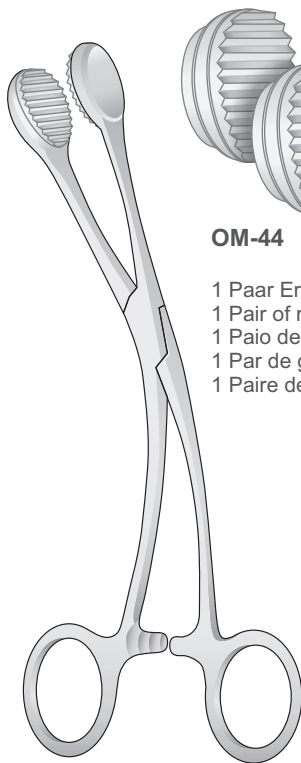

YOUNG OM-45
160 mm

OM-44

- 1 Paar Ersatzgummi
- 1 Pair of replacement rubber pads
- 1 Paio de gommini di ricambio
- 1 Par de gomas de recambio
- 1 Paire de caoutchouc de rechange

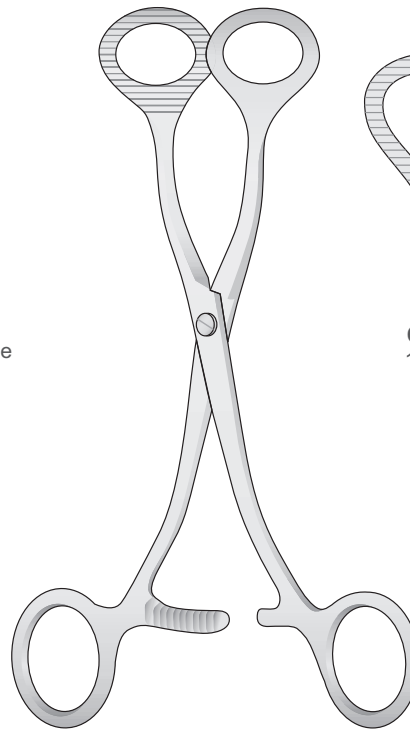

COLLIN OM-10/OM-30

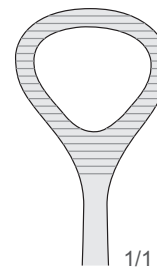

OM-30
165 mm

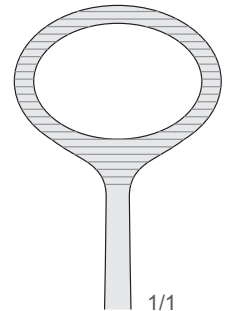

OM-10
170 mm

RETRACTORS

Mouth Props

Kette und Mundstutzen
Chain and Mouth Props
Catene e Apribocca
Cadena y Abrebocas
Chaîne et Ouvre Bouche

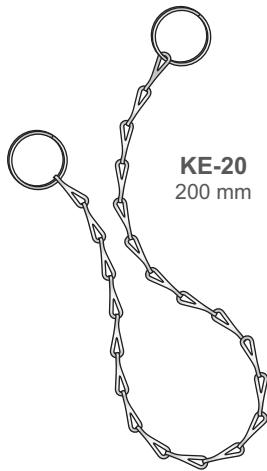

KE-20
200 mm



KE-40
400 mm

Dampfsterilisation bis 134°C
Autoclavable to 134°C
Autoclavabile a 134°C
Autoclave hasta 134°C
Autoclavable jusqu'à 134°C

Packung mit 2 Stück
Package with 2 units
Confezione da 2 pezzi
Caja con 2 unidades
Boîte avec 2 pièces

Schwarzer Gummi
Black Rubber
Gomma nera
Caucho negro
Caoutchouc noir

RETRACTORS



OM-70
SMALL
Klein, für Kinder
Small, for children
Piccolo, per bambini
Pequeño, para niños
Petit, pour enfants



OM-71
MEDIUM
Normal, für Erwachsene
Regular, for adults
Normale, per adulti
Regular, para adultos
Regulier, pour adultes

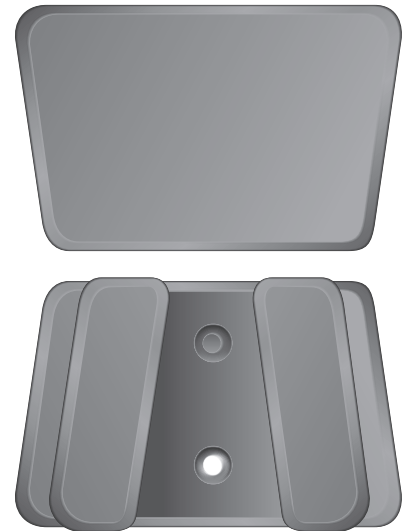

OM-72
LARGE
Groß, für Erwachsene
Large, for adults
Grande, per adulti
Grande, para adultos
Grand, pour adultes

• Implantology

199 | Oteotomes and Chisels

203 | Mallets

204 | Periosteals

205 | Trephines

206 | Periosteals

207 | Osteotomes

213 | Trephines

**214 | Bone and Tissue
Harvest Accessories**

218 | Measuring Instruments

220 | Bone Holding Forceps



Osteotome
 Osteotomes
 Osteotomi
 Osteótomos
 Ostéotomes

Oteotomes and Chisels

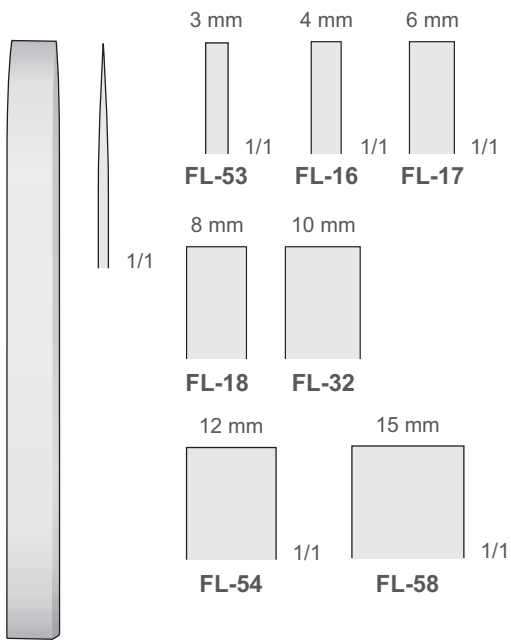

MINI-LAMBOTTE
FL-16/FL-58
 125 mm

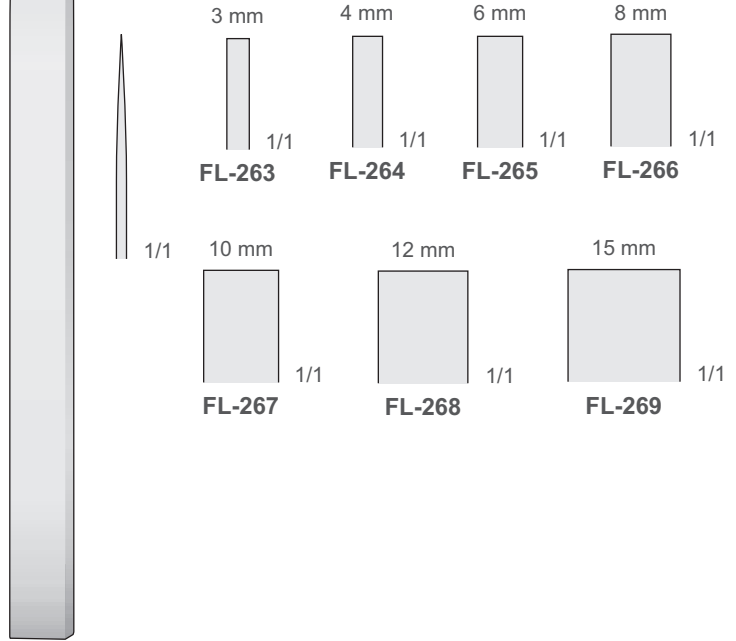

MINI-LAMBOTTE
FL-263/FL-269
 170 mm

Taglio singolo

Taglio doppio

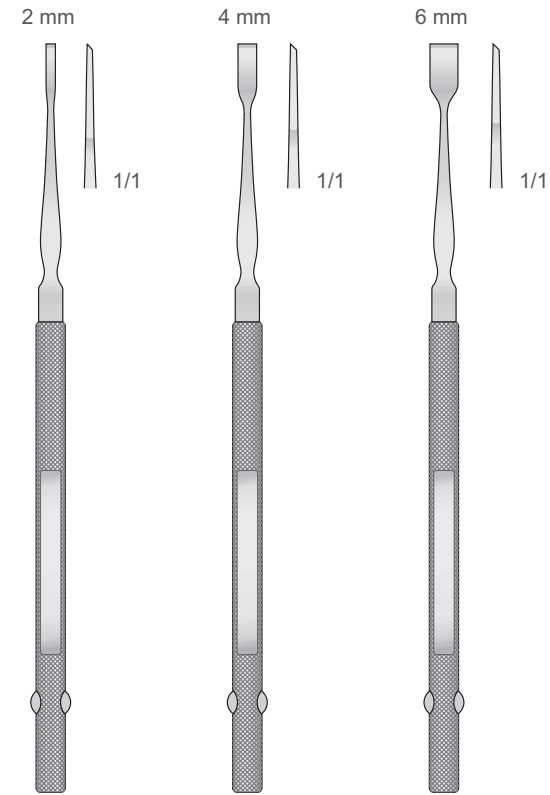

FREER
TG-10
 160 mm

FREER
TG-11
 160 mm

FREER
TG-12
 160 mm

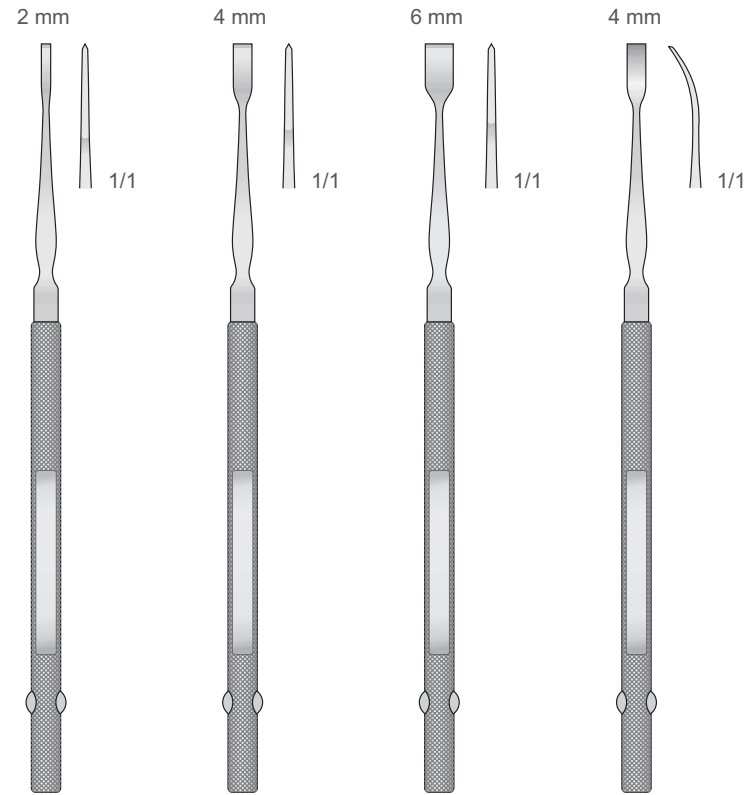

FREER
TG-20
 160 mm

FREER
TG-21
 160 mm

FREER
TG-22
 160 mm

FREER
TG-23
 160 mm

IMPLANTOLOGY

Osteotome - Meißel
 Osteotomes - Gouges
 Osteotomi - Sgorbie
 Osteótomos - Gubias
 Ostéotomes - Gouges

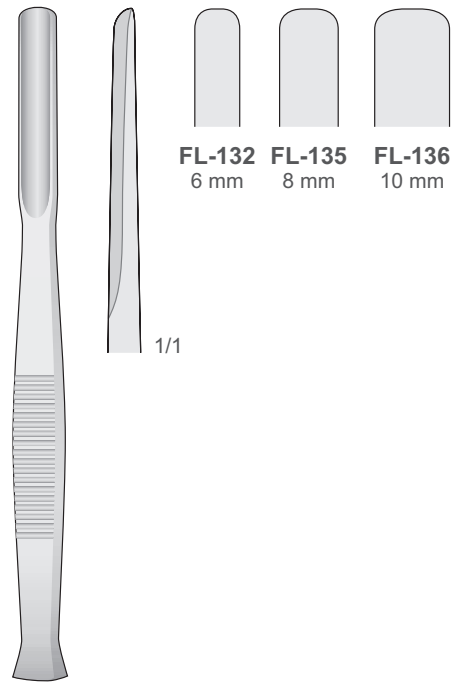
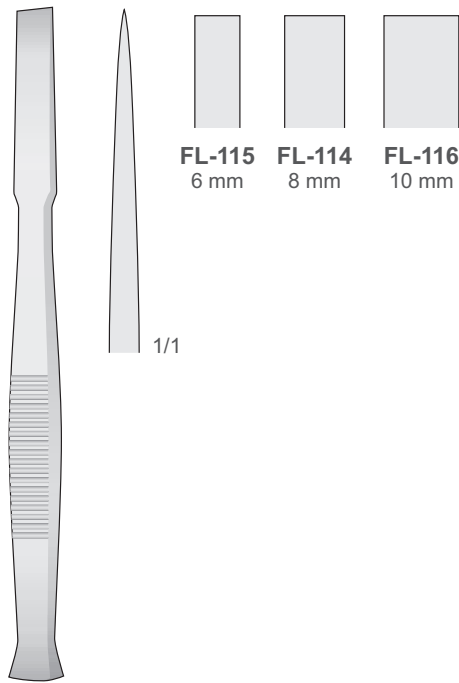

FL-114/FL-116
140 mm

FL-132/FL-136
140 mm

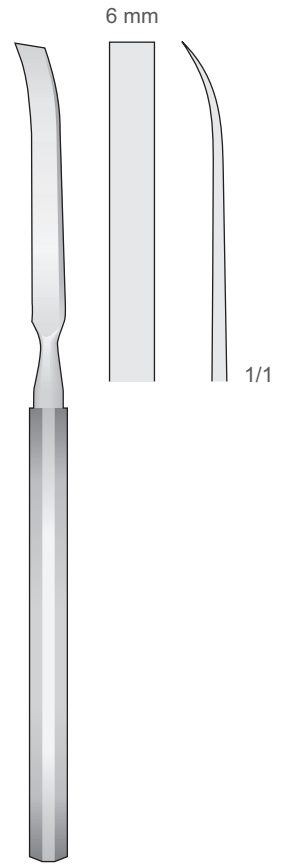
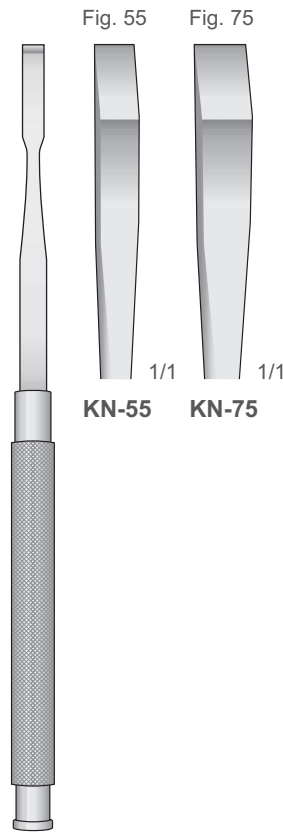
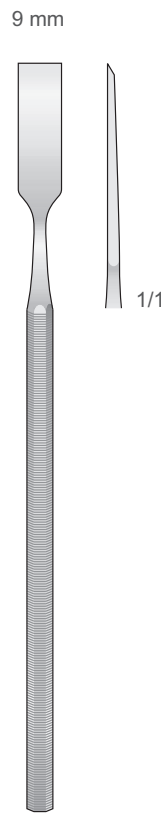
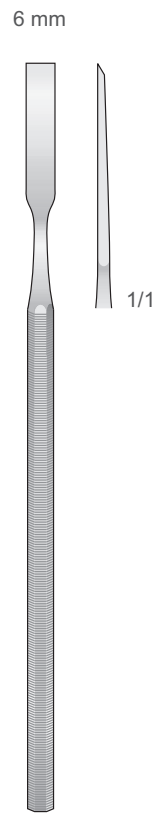
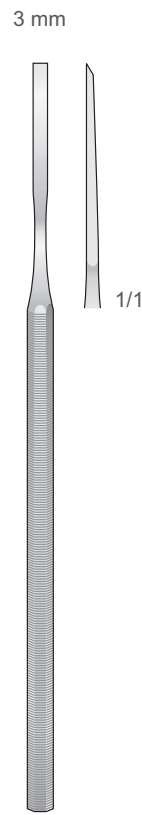
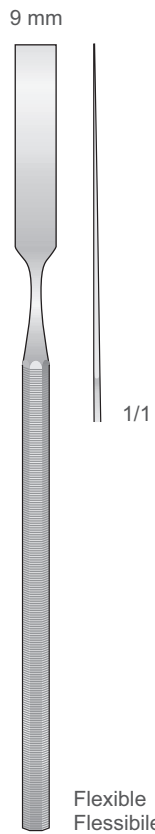

TG-15
170 mm

TG-30
155 mm

TG-31
155 mm

TG-32
155 mm

KRAMER-NEVINS
KN-55/KN-75
175 mm

DO-196
180 mm

IMPLANTOLOGY

Osteotome - Hohlmeissel
 Osteotomes - Gouges
 Osteotomi - Scalpelli
 Osteótomos - Cinceles
 Ostéotomes - Scalpel

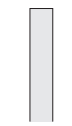
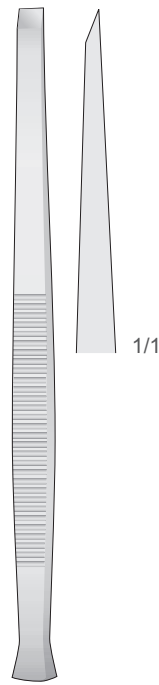

FL-13
3 mm

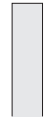

FL-14
4 mm



FL-15
5 mm

PARTSCH
FL-13/FL-15
 140 mm

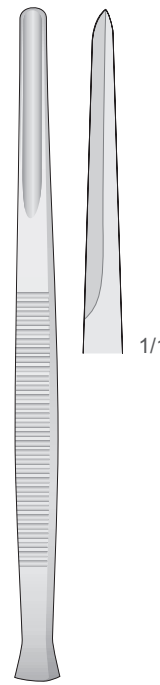

FL-03
3 mm



FL-04
4 mm



FL-05
5 mm

PARTSCH
FL-03/FL-05
 140 mm

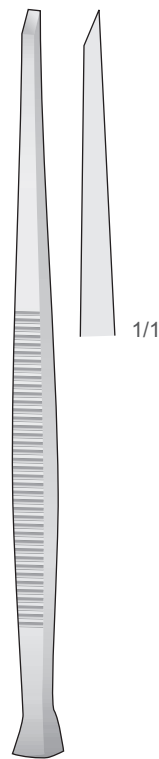

FL-177
3 mm



FL-183
6 mm



FL-179
4 mm



FL-184
7 mm



FL-181
5 mm

PARTSCH
FL-177/FL-184
 170 mm

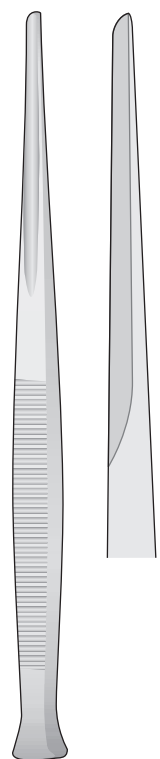

FL-185
3 mm



FL-188
6 mm



FL-186
4 mm



FL-189
7 mm



FL-187
5 mm

PARTSCH
FL-185/FL-189
 170 mm

IMPLANTOLOGY

Osteotome - Meissel
 Osteotomes - Chisels
 Osteotomi - Scalpelli
 Osteótomos - Cinceles
 Ostéotomes - Burins

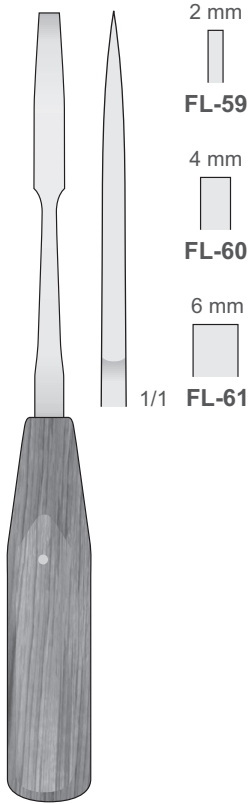

MINI-LEXER
 FL-59/FL-61
 200 mm

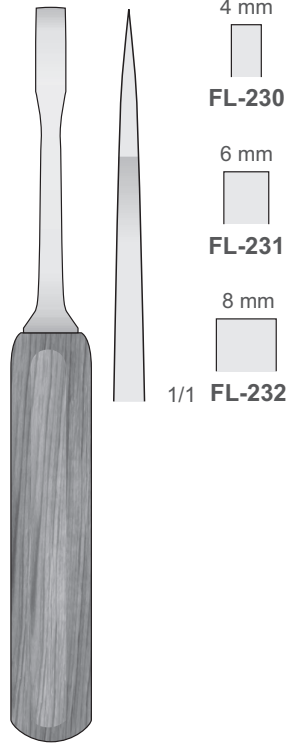

MINI-LEXER
 FL-230/FL-232
 180 mm

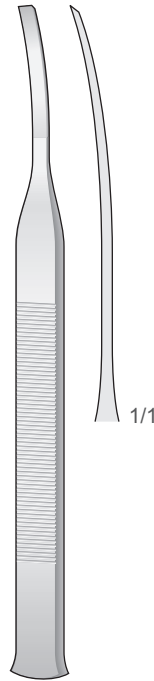

TESSIER
 FL-411 5 mm
 FL-412 7 mm
 160 mm



TESSIER
 FL-413/FL-416
 160 mm

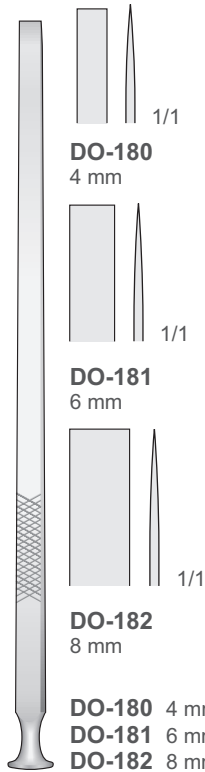
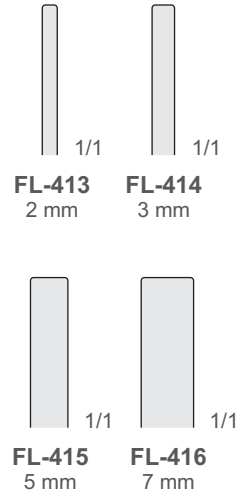

EPKER
 DO-180/DO-182
 180 mm

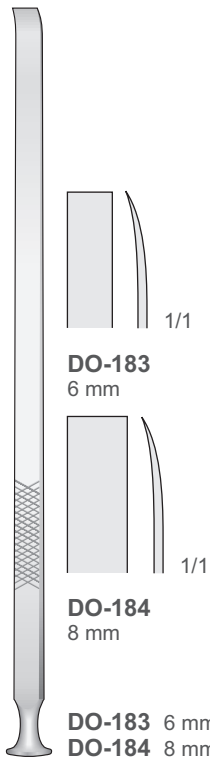

EPKER
 DO-183/DO-184
 180 mm

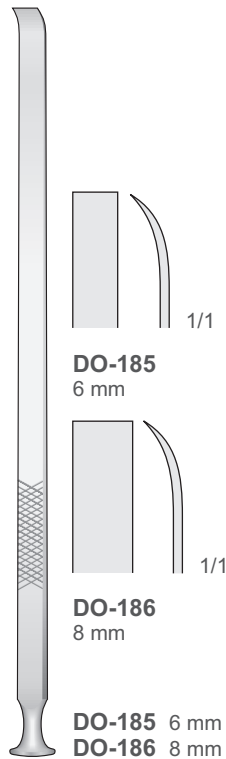

EPKER
 DO-185/DO-186
 180 mm

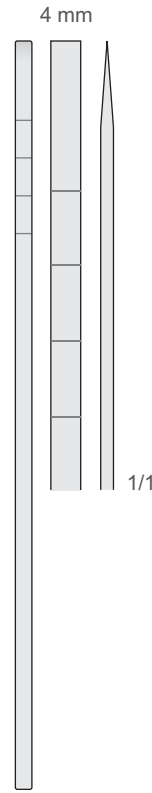

COTTLE
 DO-140
 180 mm

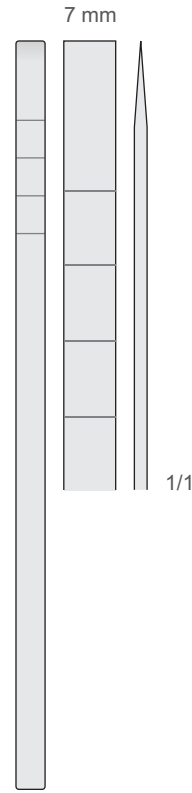

COTTLE
 DO-141
 180 mm

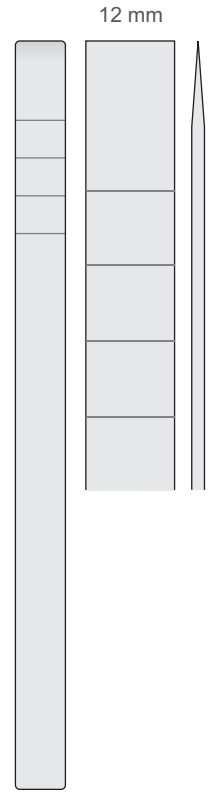

COTTLE
 DO-143
 180 mm

Chirurgische Hämmer
Surgical mallets
Martelli chirurgici
Martillos quirúrgicos
Maillets chirurgicaux

Ø 20 mm - 140 g



FL-01
165 mm

Ø 25 mm - 300 g

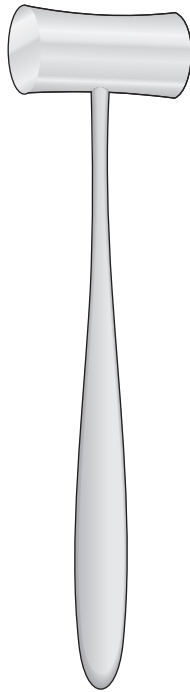

**LUCAE
FL-10M**
190 mm

Ø 27 mm - 135 g

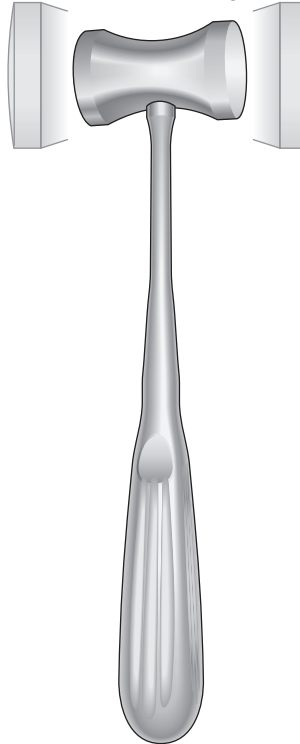

**HAJEK
FL-128**
200 mm

Ø 30 mm - 240 g

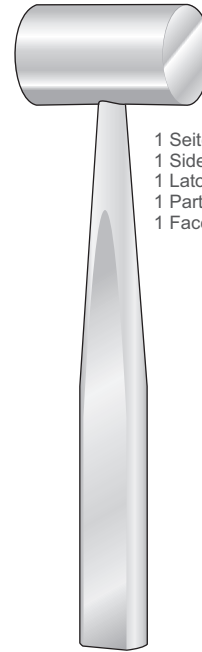

1 Seite flach - 1 Seite convex
1 Side flat - 1 Side convex
1 Lato piatto - 1 Lato convesso
1 Parte plana - 1 Parte convexa
1 Face plate - 1 Face convexe

**COTTLE
FL-104**
185 mm

Ø 20 mm - 160 g

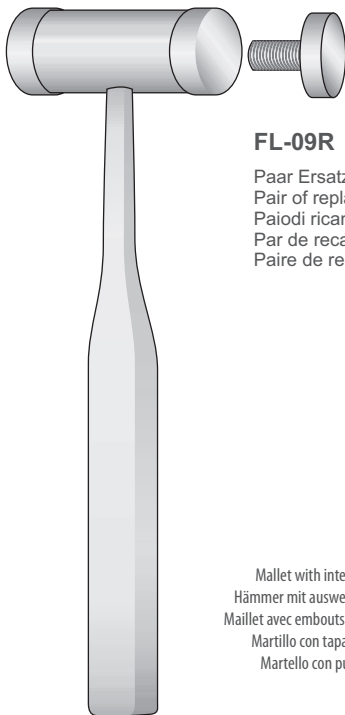

FL-09R
Paar Ersatzbacken
Pair of replacement
Paiodi ricambio
Par de recambio
Paire de rechange

Mallet with interchangeable plastic disks
Hämmer mit auswechselbaren Kunststoffbacken
Maillet avec embouts de plastique interchangeables
Martillo con tapas plásticas reemplazables
Martello con punte di ricambi in teflon

**MEAD
FL-09**
190 mm

Ø 25 mm - 200 g

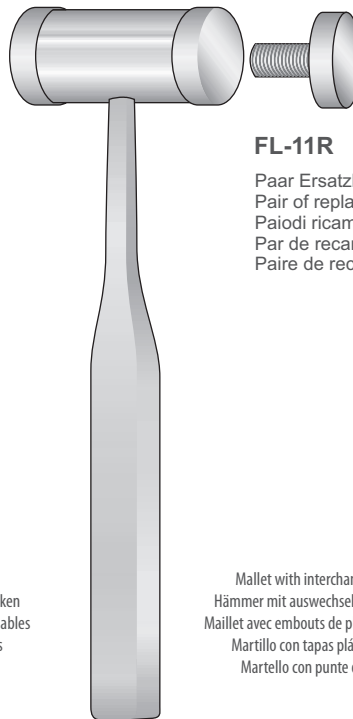

FL-11R
Paar Ersatzbacken
Pair of replacement
Paiodi ricambio
Par de recambio
Paire de rechange

Mallet with interchangeable plastic disks
Hämmer mit auswechselbaren Kunststoffbacken
Maillet avec embouts de plastique interchangeables
Martillo con tapas plásticas reemplazables
Martello con punte di ricambi in teflon

**MEAD
FL-11**
200 mm

Ø 26 mm - 320 g

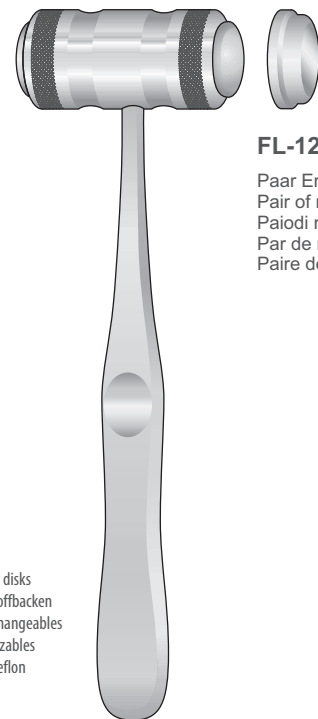

FL-12R
Paar Ersatzbacken
Pair of replacement
Paiodi ricambio
Par de recambio
Paire de rechange

**MEAD
FL-12**
190 mm

Periosteals

Raspatorien
 Periosteals
 Scollaperiosteal
 Periostótomos
 Rugines

Sinus Lift Retraktoren - Sinus Lift Retractors
 Divaricatori per Sinus Lift - Separadores para Sinus Lift
 Écarteurs pour Sinus Lift

17 mm

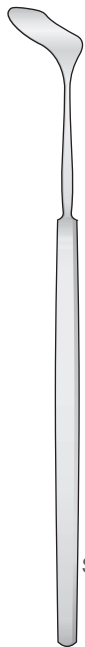

**SAUTTER
 NK-249**
 145 mm

11 mm

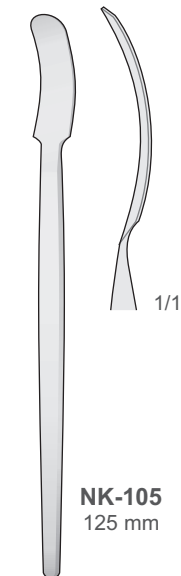

NK-105
 125 mm

9 mm

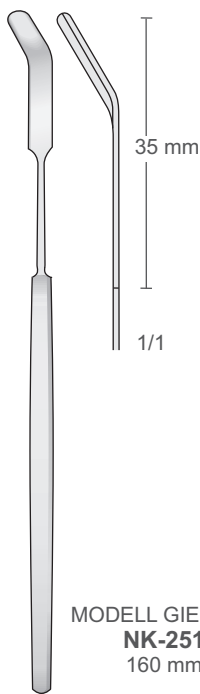

**MODELL GIESSEN
 NK-251**
 160 mm

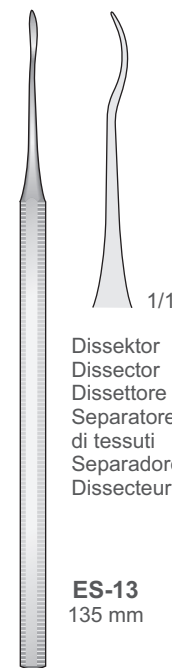

ES-13
 135 mm

Dissektor
 Dissector
 Dissetore
 Separatore
 di tessuti
 Separadores
 Dissecteur

4.5 mm

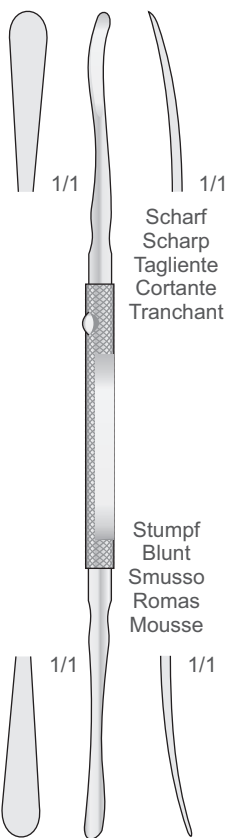

FREER
 180 mm

Scharf
 Scharp
 Tagliente
 Cortante
 Tranchant

Stumpf
 Blunt
 Smusso
 Romas
 Mousse

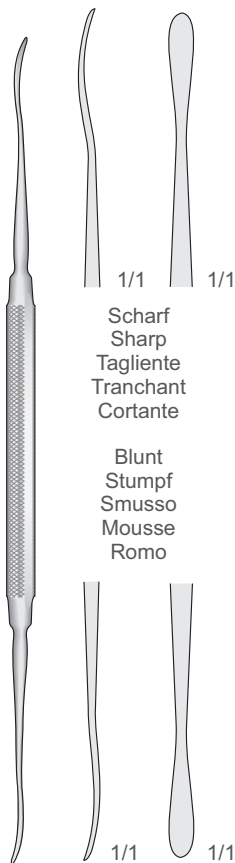

**FREER
 FR-16**
 185 mm

Scharf
 Sharp
 Tagliente
 Tranchant
 Cortante

Blunt
 Stumpf
 Smusso
 Mousse
 Romo

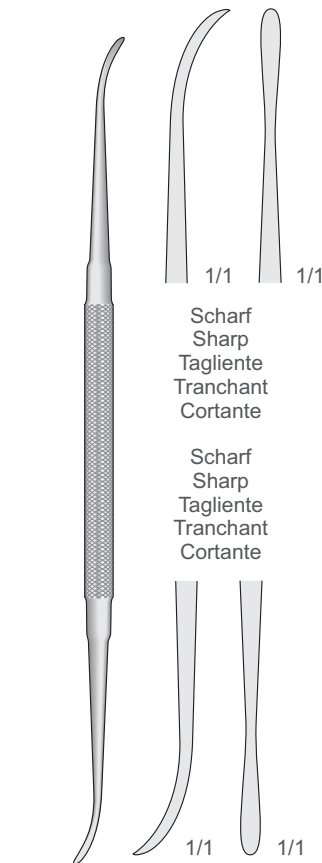

**FREER-YASARGIL
 FR-17**
 185 mm

Scharf
 Sharp
 Tagliente
 Tranchant
 Cortante

Scharf
 Sharp
 Tagliente
 Tranchant
 Cortante

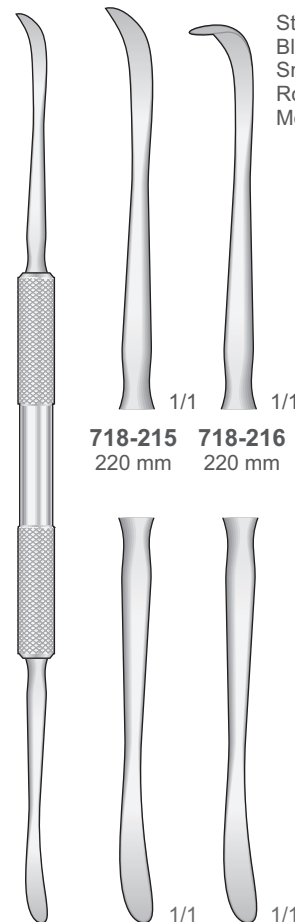

**OBWEGESER-FREER
 718-215/718-216**
 220 mm

718-215
 220 mm

718-216
 220 mm

Stumpf
 Blunt
 Smussi
 Romo
 Mousse

IMPLANTOLOGY

Trepanbohrer
Trepines
Trepine
Trépanos
Trépan

Trepines

Combination Trocar-Trepine Instruments

Bestehend aus einem Trokar, einer gezahnten Trepine und einem Kolben zur Entnahme von Knochentransplantaten aus Tibia und Beckenkamm mittels eines geschlossenen Verfahrens

Consisting of trocar, a toothed trephine and a plunger for taking tibial and iliac bone grafts through a closed technique

Composto di un trequarti, una camicia dentata ed un pistone per il prelievo degli innesti ossei dalla tibia e dalla cresta iliaca tramite una tecnica chirurgica intracutanea

Compuesto por un trócar, un trépano dentado y un émbolo para obtener injertos óseos tibiales e iliacos mediante una técnica cerrada

Composé d'un trocart, d'une tréphine dentée et d'un piston pour le prélèvement de greffes osseuses de la tibia ou de la crête iliaque par une technique fermée

FK-100

Komplettsset mit 4 Teilen
Set complete with 4 pieces
Set completo di 4 pezzi
Set completo con 4 piezas
Set complet avec 4 pièces

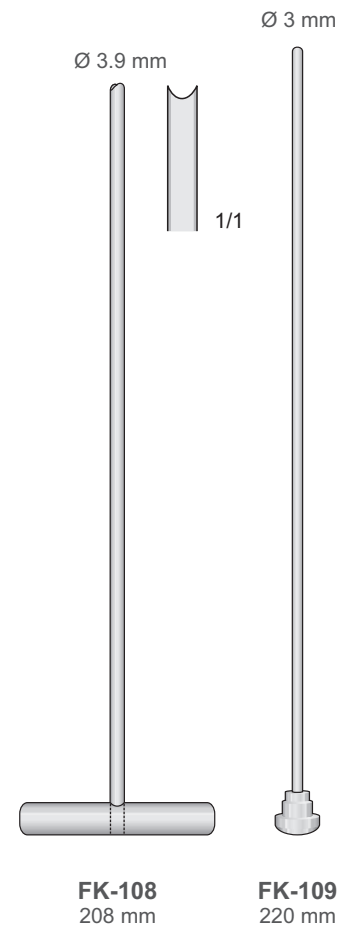
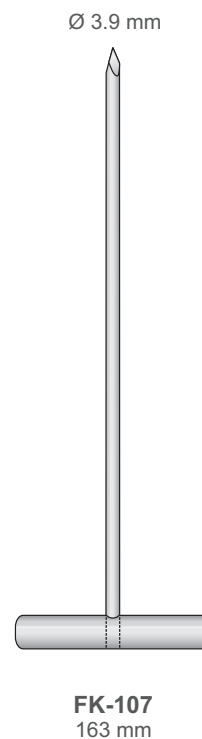
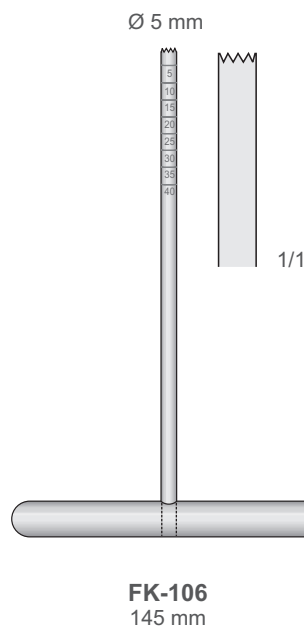
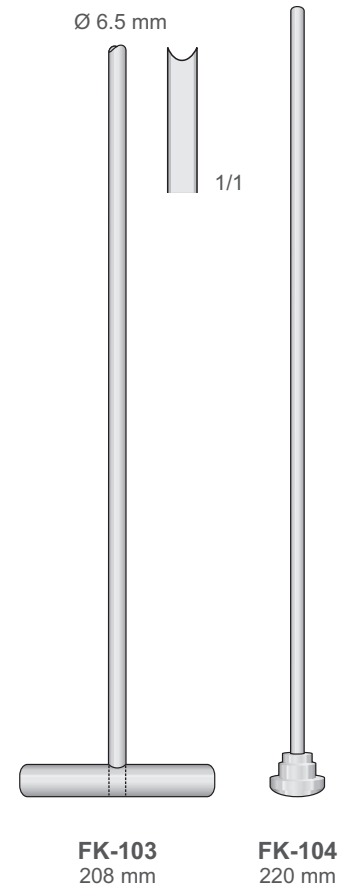
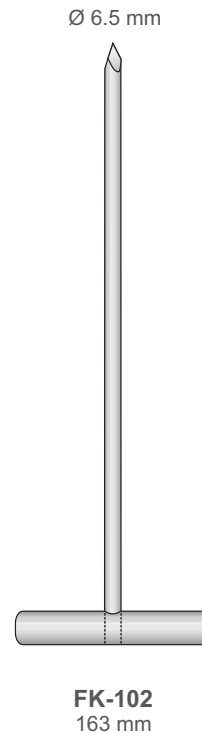
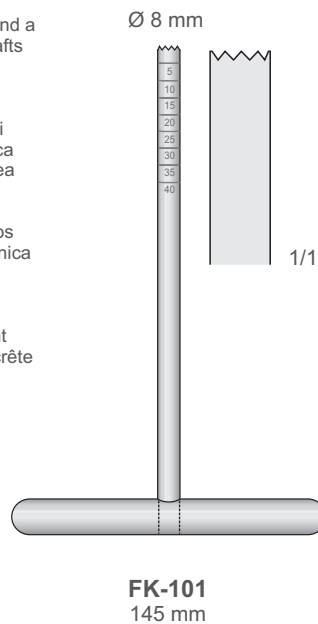

FK-105

Komplettsset mit 4 Teilen
Set complete with 4 pieces
Set completo di 4 pezzi
Set completo con 4 piezas
Set complet avec 4 pièces

Periosteals

Implantologie Instrumente
 Implantology Instruments
 Strumenti per implantologia
 Instrumentos para Implantología
 Instruments pour Implantologie



MIR-30
130 mm



MIR-31
130 mm



MIR-32
130 mm

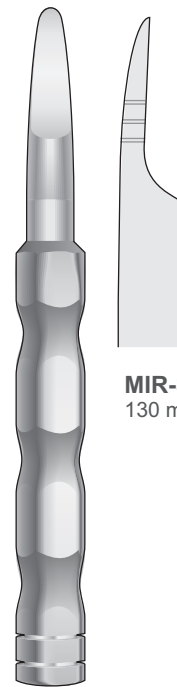

MIR-33
130 mm

BONE EXPANDERS
 Distraktoren für Knochenleiste
 Distracteurs de crête osseuse
 Expansores de cresta ósea
 Distrattori per cresta ossea

TUNNELING INSTRUMENTS
 Tunnelierinstrumente | Instruments pour tunnellation | Instrumentos para tunelización | Strumenti per tunneling

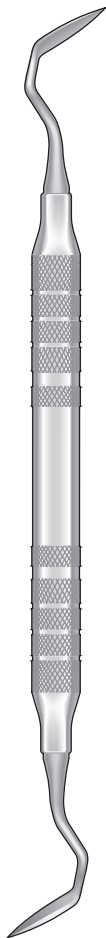

UST-1/2ML



UST-1/2MS

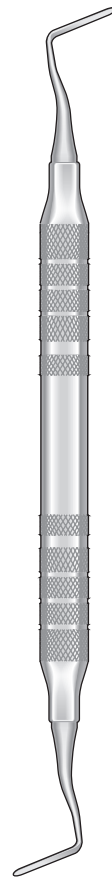

UST-KPA



USS-YG7/8



UST-MP



UST-MPA

Osteotome
 Osteotomes
 Osteotomi
 Osteótomos
 Ostéotomes

Osteotomes

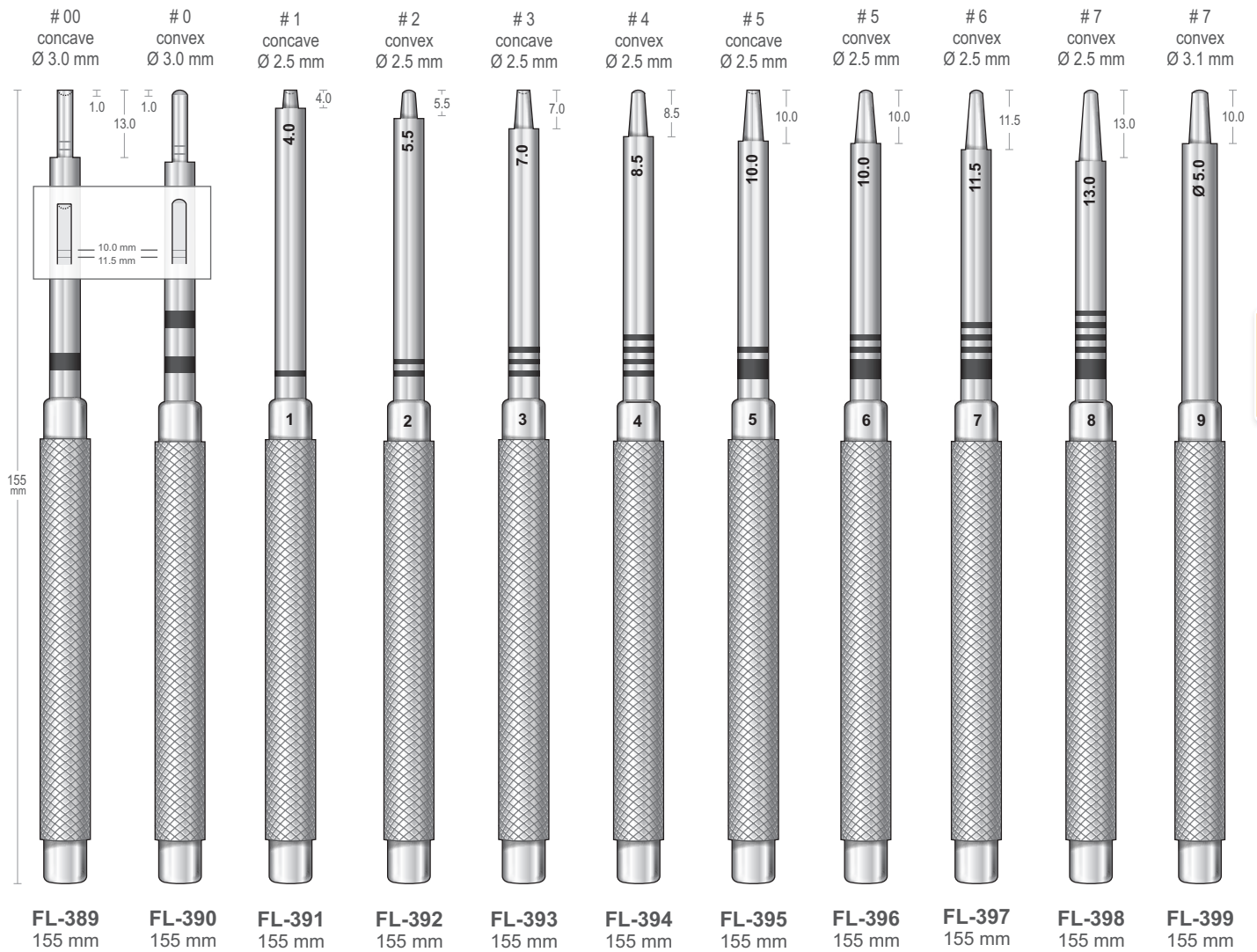

IMPLANTOLOGY

Osteotome
 Osteotomes
 Osteotomi
 Osteótomos
 Ostéotomes

# 1	Diam.
0	Ø 1.60
7.5	Ø 1.80
10	Ø 2.00
13.5	Ø 2.40
15.5	Ø 3.60

# 2	Diam.
0	Ø 1.90
7.5	Ø 2.20
10	Ø 2.35
13.5	Ø 3.30
15.5	Ø 3.40
23.5	Ø 4.50

# 3	Diam.
0	Ø 2.80
7.5	Ø 3.20
10.5	Ø 3.35
13.5	Ø 3.60
21	Ø 4.40

# 4	Diam.
0	Ø 3.10
7.5	Ø 3.70
10.5	Ø 3.90
15.5	Ø 4.30

# 5	Diam.
0	Ø 3.90
10	Ø 5.00
13	Ø 5.20
20.5	Ø 6.30

# 6	Diam.
0	Ø 5.50
10	Ø 6.20
13	Ø 6.30

1
 Ø 1.6 mm



FL-120
 155 mm

2
 Ø 1.9 mm



FL-121
 155 mm

3
 Ø 2.8 mm



FL-122
 155 mm

4
 Ø 3.10 mm



FL-123
 155 mm

5
 Ø 3.90 mm



FL-124
 155 mm

6
 Ø 5.50 mm



FL-125
 155 mm

Osteotome
 Osteotomes
 Osteotomi
 Osteótomos
 Ostéotomes

# 1	Diam.	# 2	Diam.	# 3	Diam.	# 4	Diam.	# 5	Diam.
0	Ø 1.50	0	Ø 2.10	0	Ø 2.60	0	Ø 3.00	0	Ø 3.50
5	Ø 1.90	5	Ø 2.60	5	Ø 3.00	5	Ø 3.50	5	Ø 3.90
8	Ø 2.20	8	Ø 2.80	8	Ø 3.30	8	Ø 3.80	8	Ø 4.20
10	Ø 2.40	10	Ø 3.00	10	Ø 3.50	10	Ø 4.00	10	Ø 4.40
12	Ø 2.60	12	Ø 3.20	12	Ø 3.70	12	Ø 4.20	12	Ø 4.60
14	Ø 2.80	14	Ø 3.40	14	Ø 3.90	14	Ø 4.40	14	Ø 4.80

Straight
 Gerade
 Droit
 Recto
 Diritto

Bone Pusher

1 Ø 1.5 mm # 2 Ø 2.1 mm # 3 Ø 2.6 mm # 4 Ø 3.0 mm # 5 Ø 3.5 mm Ø 2.8 mm Ø 3.5 mm Ø 4.2 mm

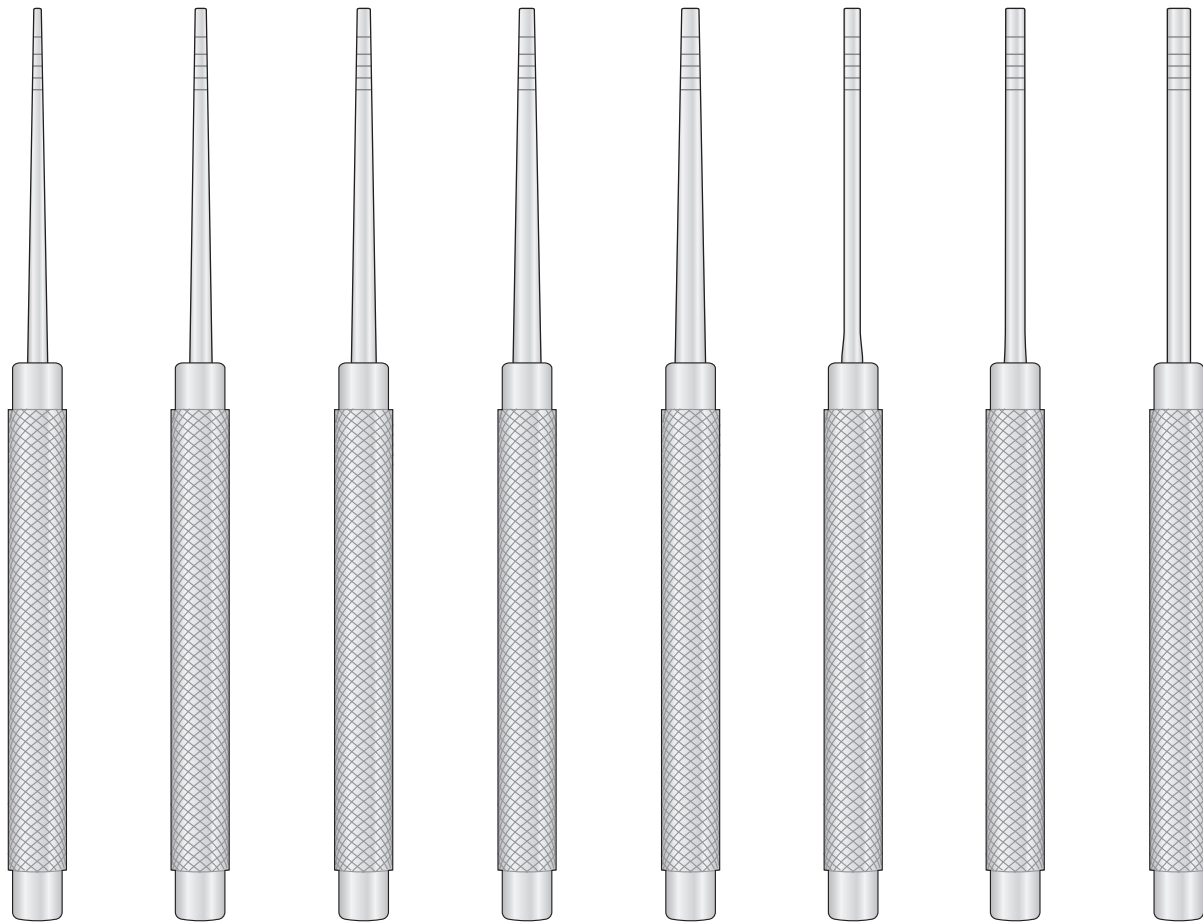

FL-292 55 mm FL-293 155 mm FL-294 155 mm FL-295 155 mm FL-296 155 mm FL-297 155 mm FL-298 155 mm FL-299 155 mm

IMPLANTOLOGY

Meißeln Graduiert
 Graduated Chisels
 Scalpelli graduati
 Cinceles graduados
 Burins gradués

3.8 mm

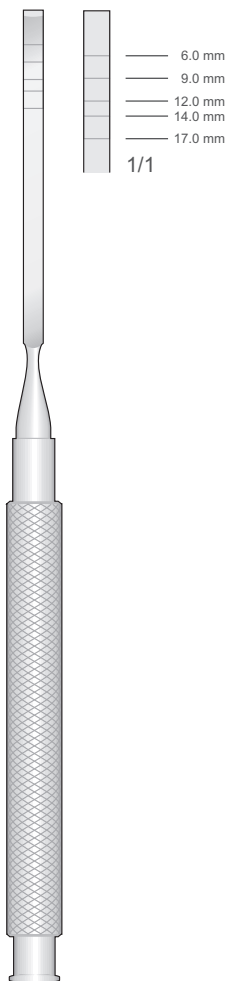

FL-141
170 mm

3.8 mm

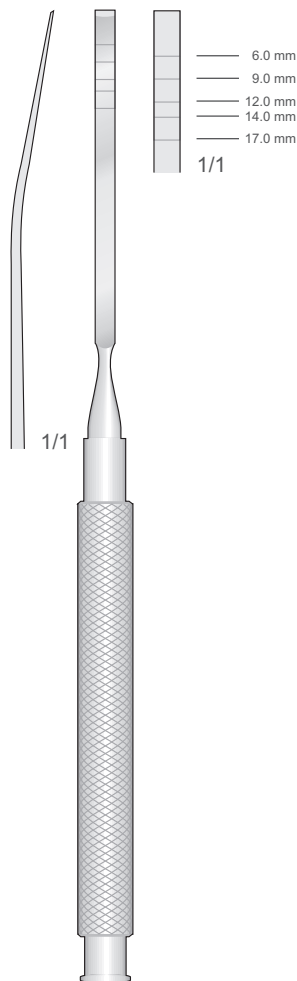

FL-142
170 mm

7.5 mm

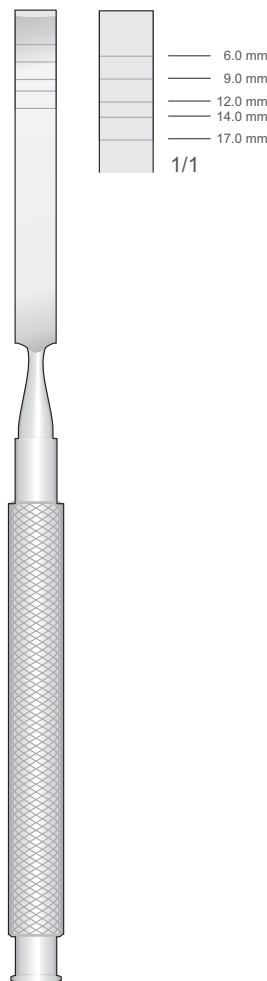

FL-143
170 mm

7.5 mm

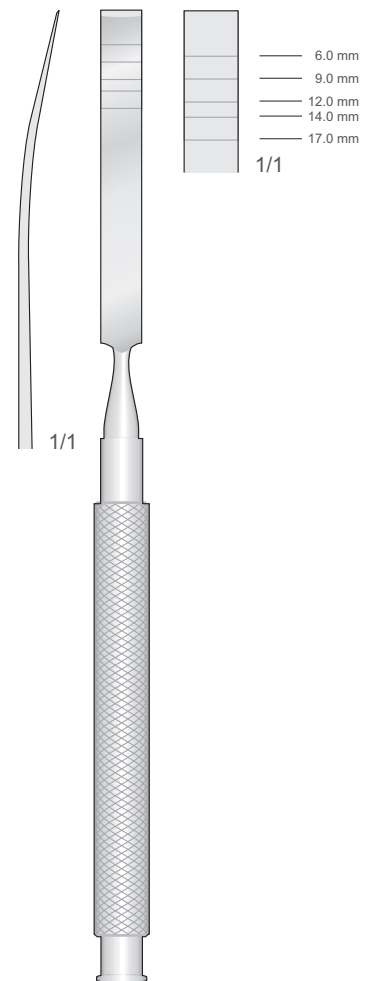

FL-144
170 mm

Osteotome
 Osteotomes
 Osteotomi
 Osteótomos
 Ostéotomes

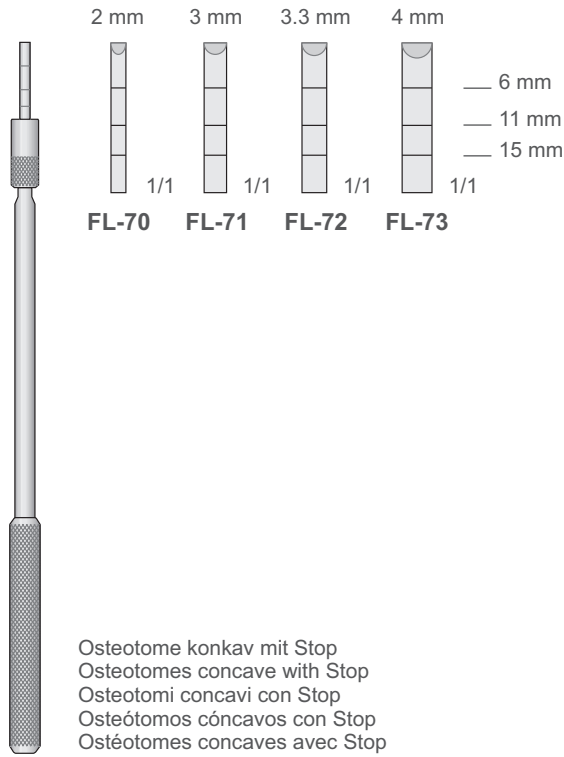

FL-70/FL-73
 165 mm

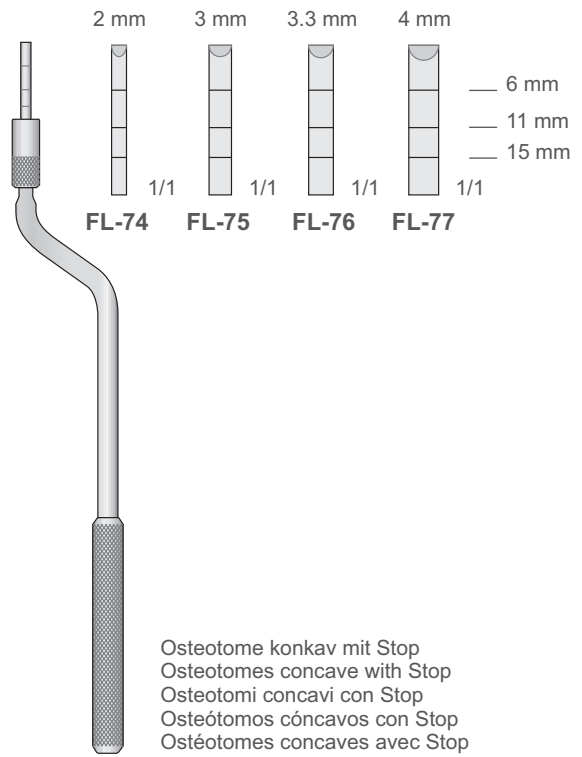

FL-74/FL-77
 165 mm

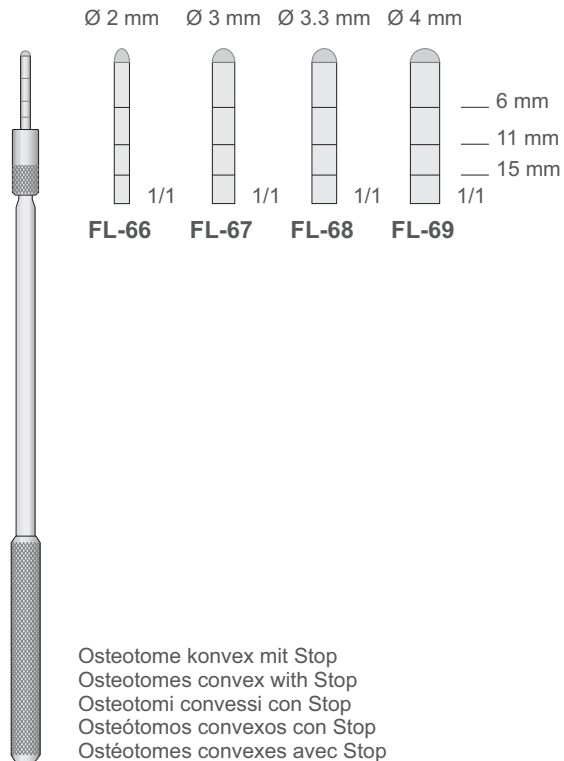

FL-66/FL-69
 165 mm

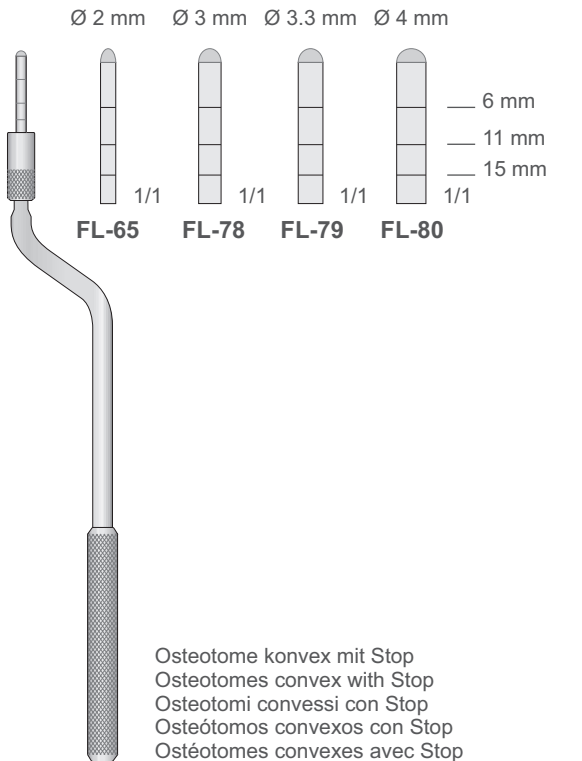

FL-65/FL-80
 160 mm

IMPLANTOLOGY

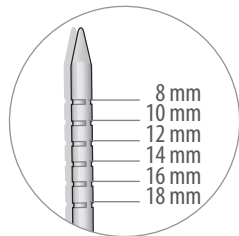

Dilatator
 Dilator
 Dilatatori
 Dilatador
 Dilatateur

A-Form

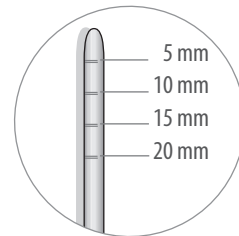

Spreader
 Spreader
 Expansori
 Expansor
 Expandeur

**D-Form
 Convex Tip**

Ø 2 mm



FL-25
 145 mm

Ø 3 mm



FL-26
 145 mm

Ø 3.3 mm



FL-27
 145 mm

Ø 4 mm



FL-28
 145 mm

Ø 3 mm



FL-37
 145 mm

Ø 4 mm



FL-38
 145 mm

Ø 5 mm



FL-39
 145 mm

For Tissue
Für Gewebe
Pour tissu
Para tejido
Per tessuto

Nicht Gezahnt
Non Serrated
No dentellato
No dentado
Non dentelé

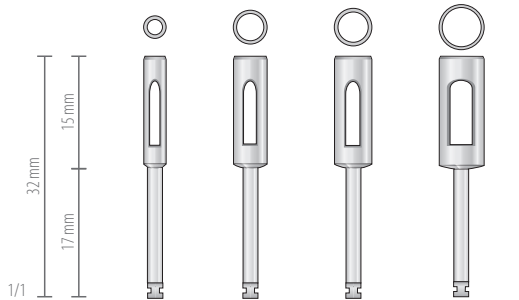

Ø mm	GA-63	GA-64	GA-65	GA-66
Int.	2.5	4.0	4.5	5.5
Ext.	3.0	4.5	5.0	6.0

For Bone
Für Knochen
Pour os
Para hueso
Per osso

Gezahnt
Serrated
Dentellato
Dentado
Dentelé

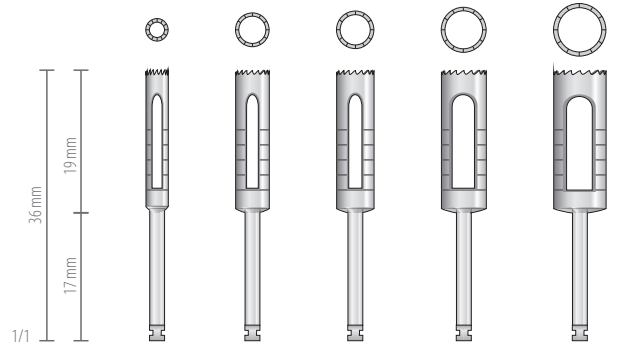

Ø mm	GA-33	GA-34	GA-35	GA-36	GA-37
Int.	2.5	4.0	4.5	5.5	6.5
Ext.	3.0	4.5	5.0	6.0	7.0

Hautstanzen
Tissue Punches
Mucotomi Punches
Bisturí circular para tejido
Bistouri circulaire pour tissue

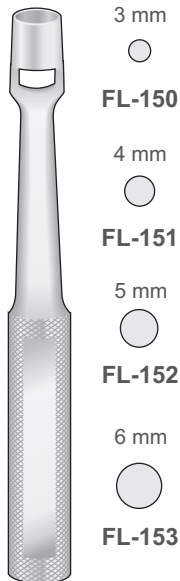

KEYES
FL-150/FL-153
100 mm

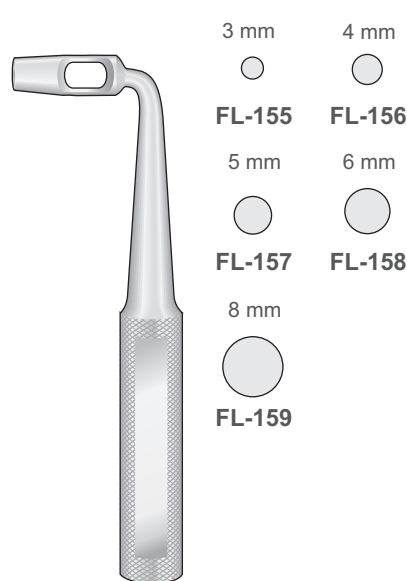

KEYES
FL-155/FL-159
90 mm

Implant Graduierung
Implant depth gauge with ball end
Sonda per controllare la profondità del sito
Sonda para controlar la profundidad

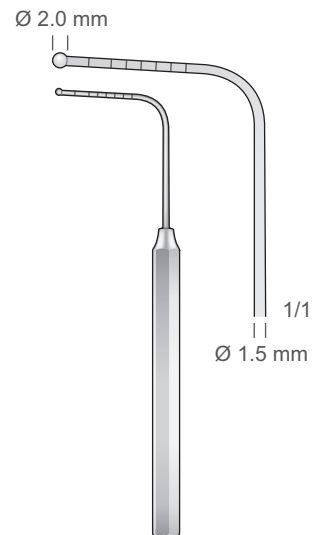

GA-60
100 mm

Bone and Tissue Harvest Accessories

Implantologie Instrumente
 Implantology Instruments
 Strumenti per implantologia
 Instrumentos para Implantología
 Instruments pour Implantologie



**PELTON-CRANE
 TS-40**
 Connection Piece
 int. Ø 7.5 mm
 ext. Ø 10.0 mm
 75 mm

inox Stainless Steel

Schalen
 Bowl
 Ciotola
 Cuenco
 Bacinella

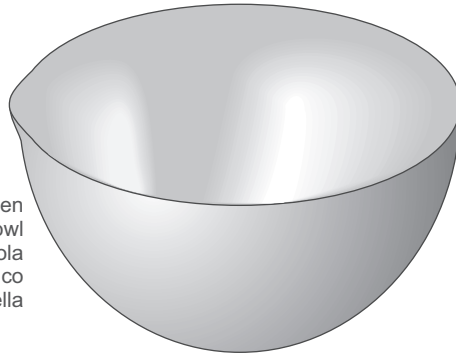

- CS-01** Ø 40 mm, 15 cc - 0.5 oz
- CS-02** Ø 60 mm, 75 cc - 2.5 oz
- CS-03** Ø 80 mm, 225 cc - 7.5 oz
- CS-04** Ø 100 mm, 325 cc - 11 oz
- CS-05** Ø 120 mm, 500 cc - 17 oz
- CS-06** Ø 150 mm, 600 cc - 20 oz



Knochenschale
 Bone Well
 Bacinella per osso
 Cubeta para hueso
 Cuvette à os
 Amalgambecher
 Amalgam Well
 Mortaio per amalgama
 Recipiente para amalgama
 Gobelet pour amalgame

SS-65
 Ø 35x35 mm
 depth 15 mm
 5cc - 0.17oz

Absaugkanülen für Knochen mit Filter
 Suction tube for bone with filter
 Cannule d'aspiration con trattenuta osso con filtro
 Cánulas aspiradoras para hueso con filtro
 Canule d'aspiration pour os avec filtre

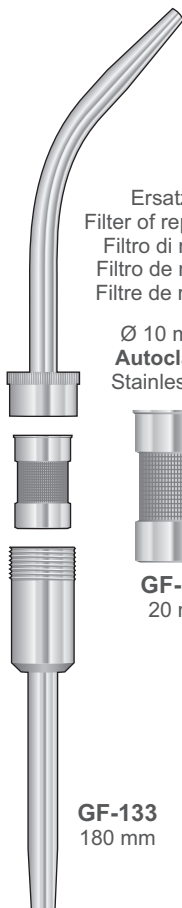

Ersatzfilter
 Filter of replacement
 Filtro di ricambio
 Filtro de recambio
 Filtre de rechange

Ø 10 mm int.
Autoclavable
 Stainless Steel



1/1

GF-133
 180 mm

Membranplatzierungsinstrumente
 Membrane Placement Instruments
 Strumenti per posizionare membrana
 Instrumentos para colocar membranas
 Instruments pour application de membrane



MPI-1
 185 mm

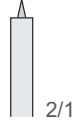

2/1

1/1



**LUNIATSCHEK
 PF-6**
 170 mm



1/1

1/1

Aufbring Instrument für Knochenmaterial
 Applicator for bone material
 Applicatore per materiale osseo
 Cucharillas para material oseu
 Applicateur pour matière osseuse



IM-15
 180 mm



1/1

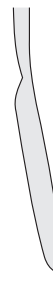

1/1

Knochenmühlen - und spritzen
 Bone Mills and Syringes
 Macina e siringhe per osso
 Molinos y jeringas para hueso
 Moulin et seringues à os



GA-18
Lower
Titanium



GA-17
Upper
Titanium

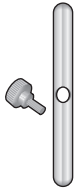

GA-19
Handle
with screw

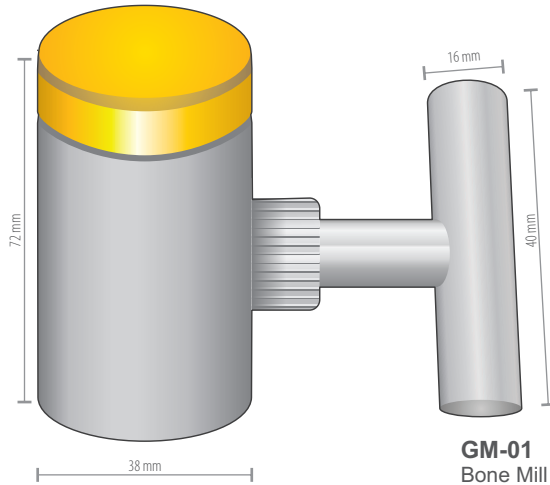

GM-01
Bone Mill / Large
Dimensions: Ø 38 x 72 mm
Mill hole: Ø 0.71 mm
Volume: 2 cc.
Particle size: 710 µ (microns)

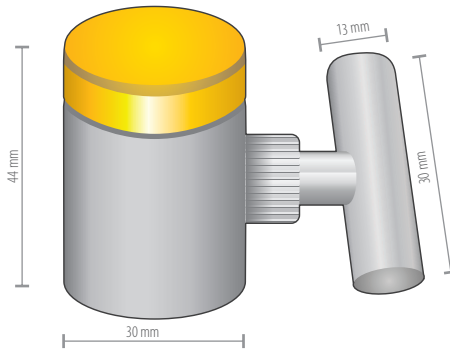

GM-02
Bone Mill / Small
Dimensions: Ø 30 x 44 mm
Mill hole: Ø 0.65 mm
Volume: 1 cc.
Particle size: 650 µ (microns)

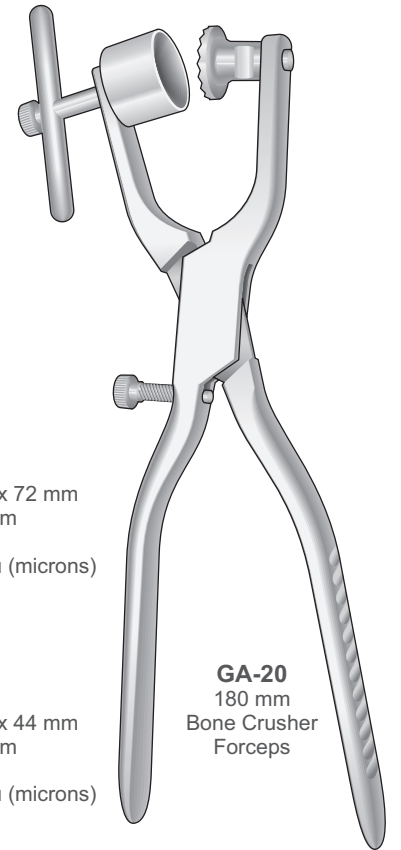

GA-20
180 mm
Bone Crusher
Forceps

Ø int. 2.5 mm
Ø ext. 3.5 mm

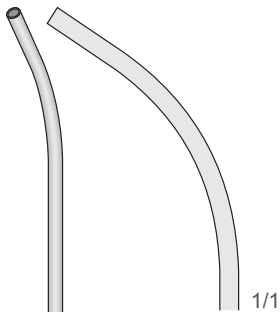

SS-60M
160 mm

Ø int. 3.5 mm
Ø ext. 4.5 mm

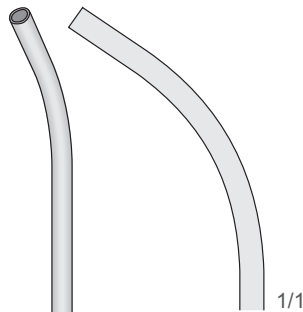

SS-61M
160 mm

Ø int. 4.4 mm
Ø ext. 5.5 mm

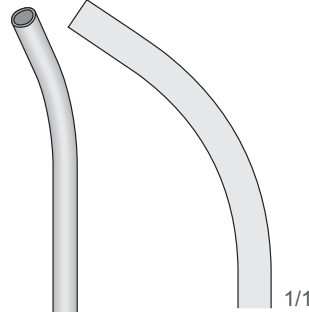

SS-62M
160 mm

Ø int. 6 mm
Ø ext. 7 mm

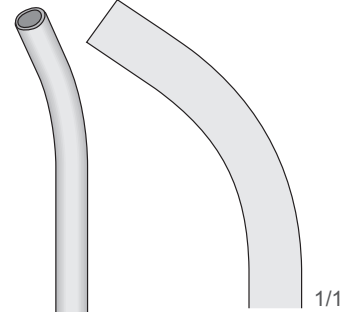

SS-64M
160 mm

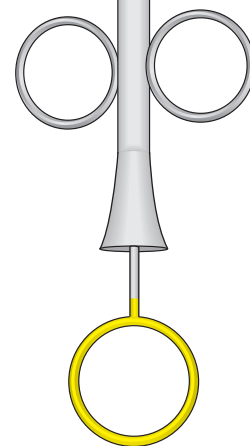
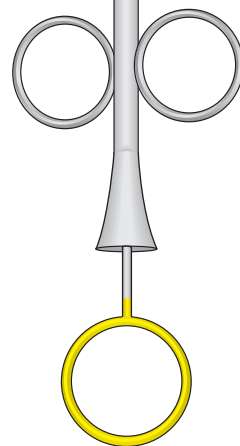
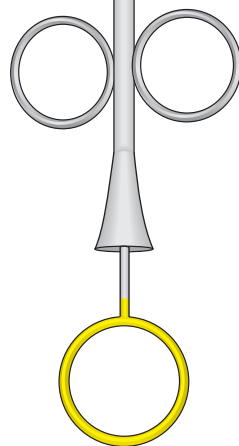
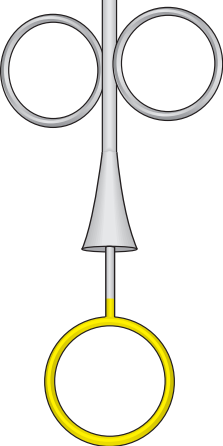

IMPLANTOLOGY

Knochenstopfer
 Bone Tampers - Bone Grafting Packers
 Compattatore per osso
 Compactador para hueso
 Compacteur à os

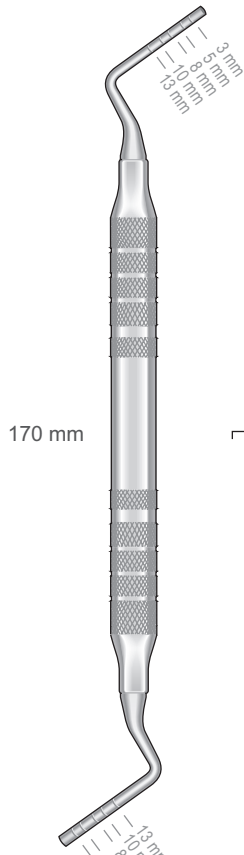

	Non Serrated Tips		Serrated Tips	
USB-P1	○ Ø 1.8	○ Ø 2.8	● Ø 1.8	● Ø 2.8
USB-P2	○ Ø 3.2	○ Ø 3.8	● Ø 3.2	● Ø 3.8
USB-P3	○ Ø 4.2	○ Ø 4.8	● Ø 4.2	● Ø 4.8
USB-P4	○ Ø 5.0	○ Ø 5.5	● Ø 5.0	● Ø 5.5

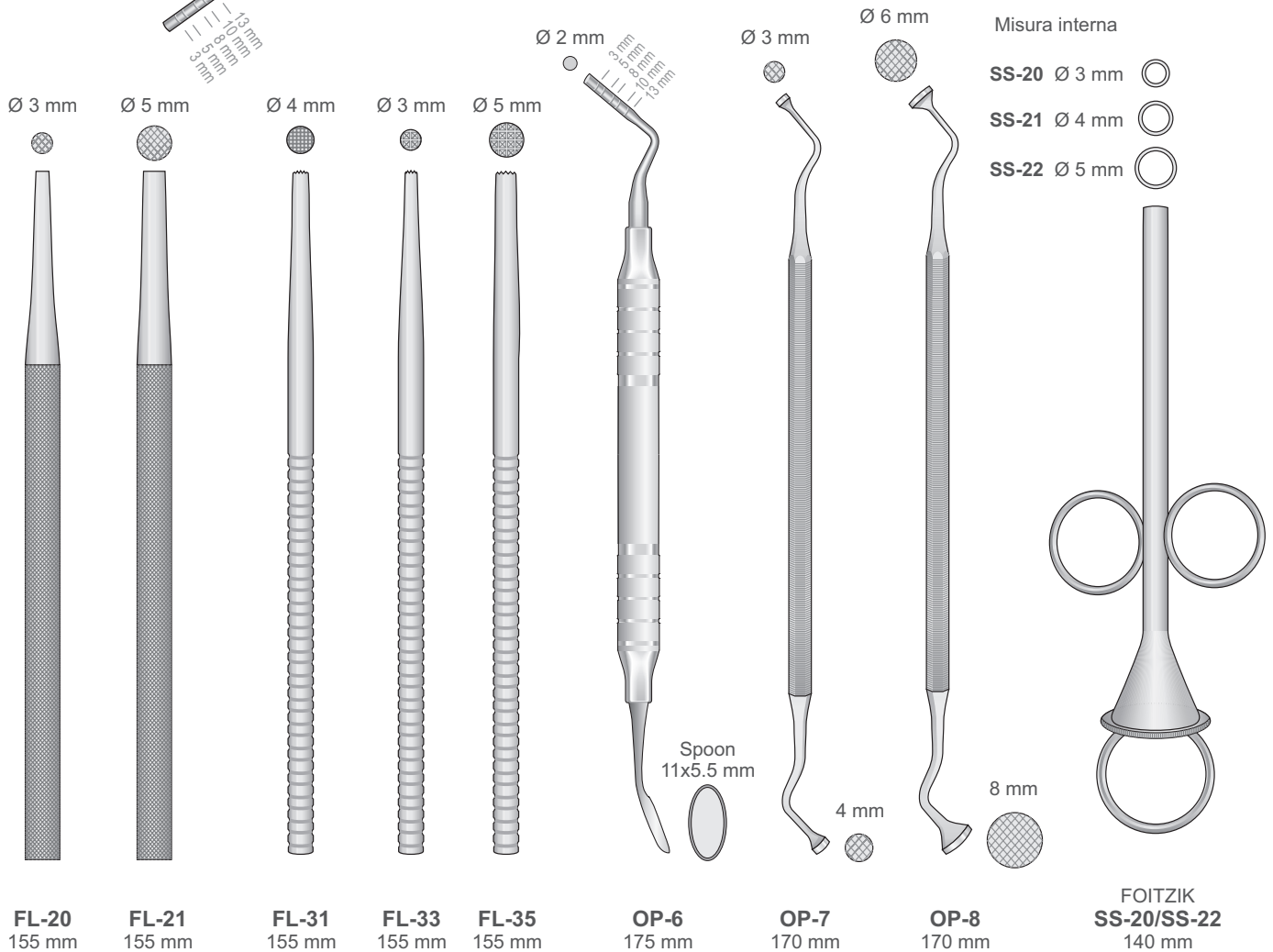

IMPLANTOLOGY

Knochenschaber. Rostfrei Stahl
 Bone-Grafter. Stainless Steel
 Grattini per osso. Inox
 Raspador de hueso. Acero inoxidable
 Racleur d'os. Acier inoxydable

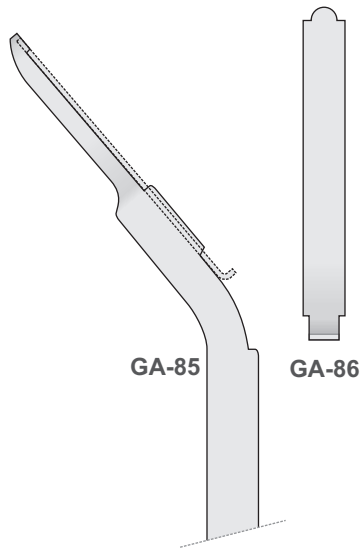

GA-85

GA-86

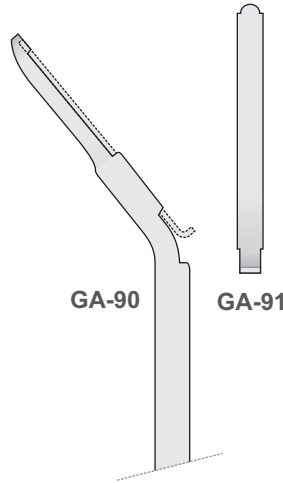

GA-90

GA-91

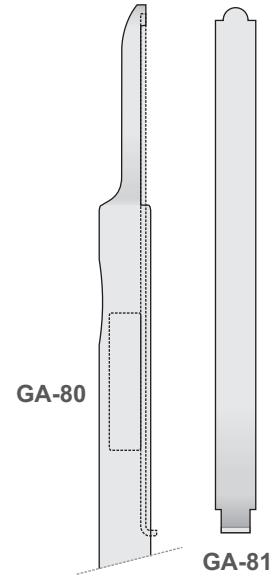

GA-80

GA-81

Knochenschaber mit Reibeklinge
 Bone-Grafter with blade
 Grattino con lama
 Raspador de hueso con hoja
 Racleur d'os avec lame

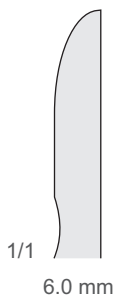

1/1

6.0 mm

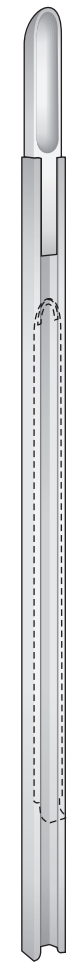

GA-70
170 mm



GA-71
90 mm

Knochenreibeschlinge
 Replacement Blade
 Lama di ricambio
 Hoja de recambio
 Lâme de rechange

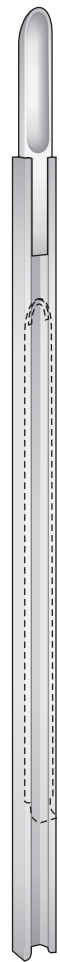

GA-73
170 mm

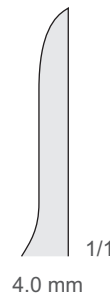

4.0 mm

1/1

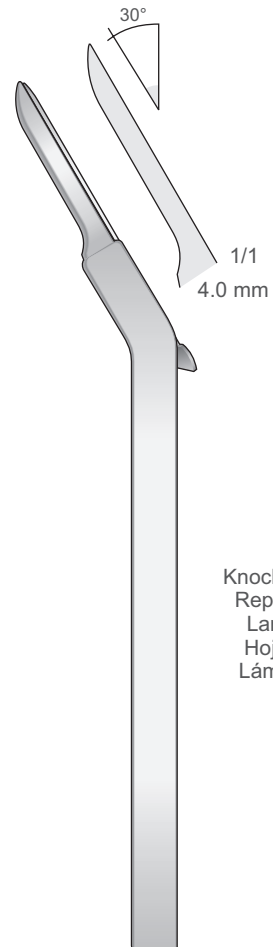

GA-78
155 mm

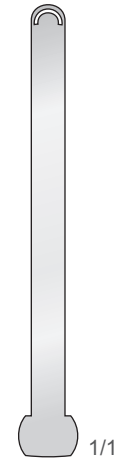

GA-79
60 mm

Knochenreibeschlinge
 Replacement Blade
 Lama di ricambio
 Hoja de recambio
 Lâme de rechange



Meßbereich: 0 - 20 mm
Measuring range: 0 - 20 mm
Campo di misura: 0 - 20 mm
Alcance de medición: 0 - 20 mm
Etendue de mesure: 0 - 20 mm

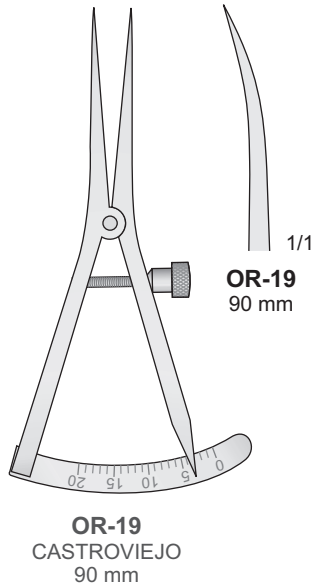

Meßbereich: 0 - 80 mm
Measuring range: 0 - 80 mm
Campo di misura: 0 - 80 mm
Alcance de medición: 0 - 80 mm
Etendue de mesure: 0 - 80 mm

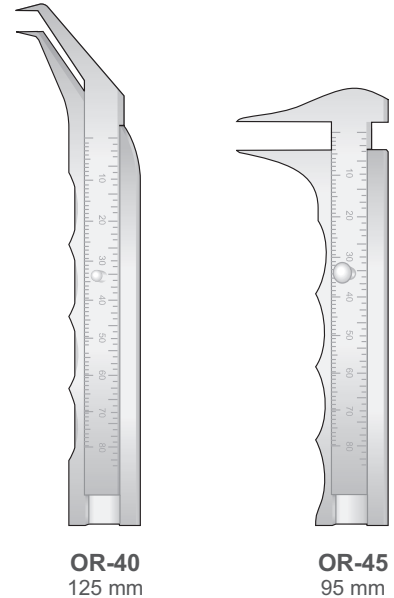

0 - 40 mm
Meßbereich / Measuring range / Campo di misura
Alcance de medición / Etendue de mesure

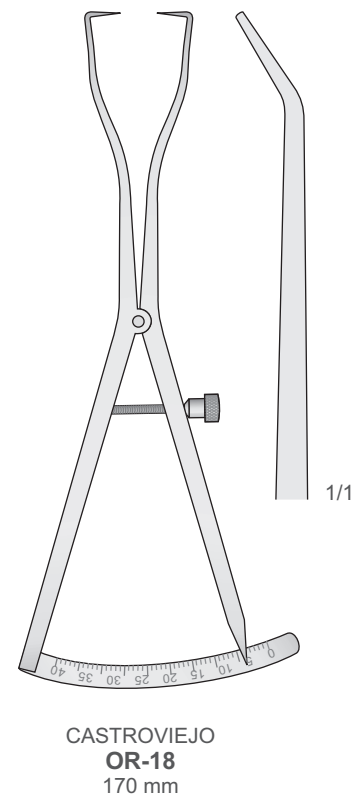
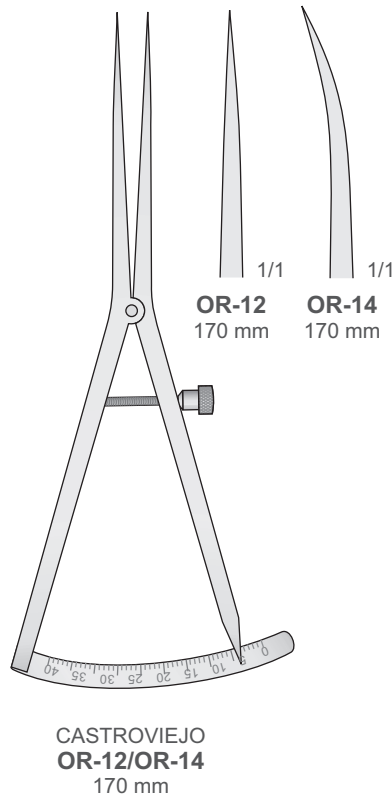
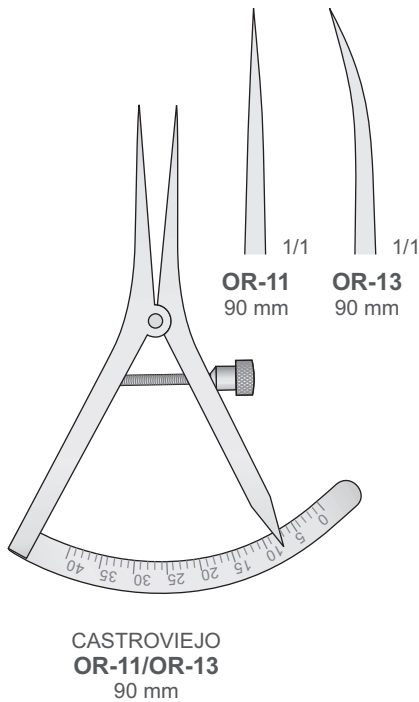

Osteometer
 Osteometer
 Osteometro
 Osteometro
 Osteometer

TRIDIMENSIONAL IMPLANTOLOGY CALIPER

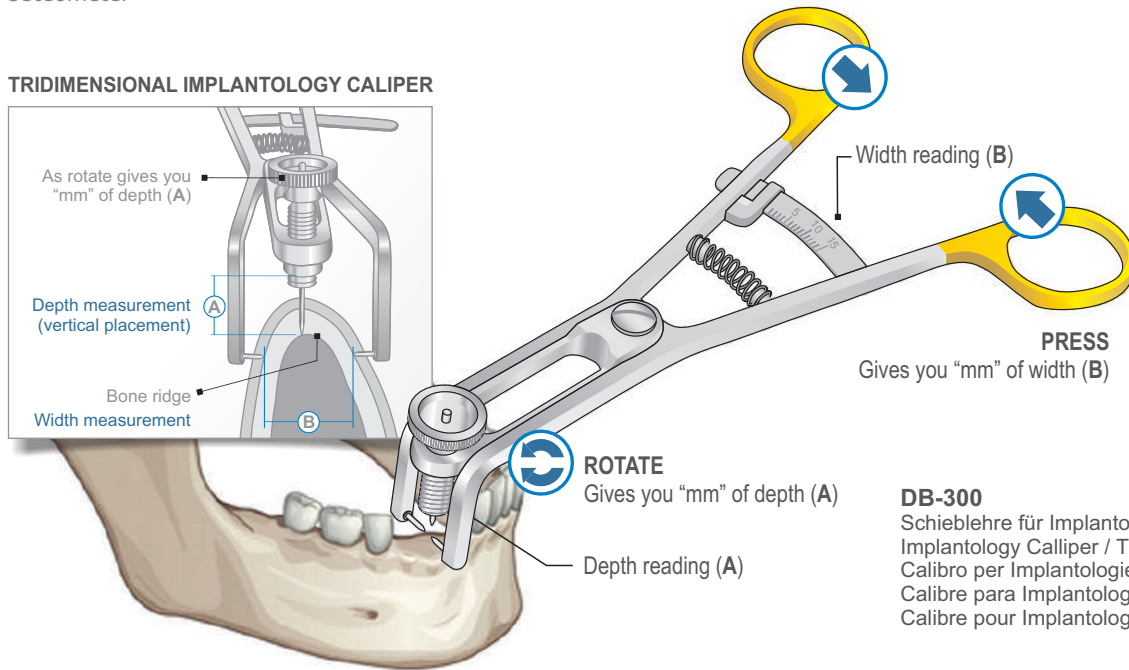
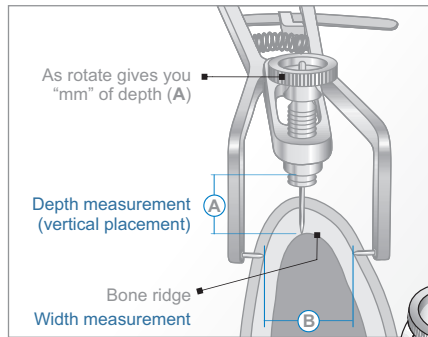

DB-300
 Schieblehre für Implantologie / Drei-Dimensional
 Implantology Calliper / Tridimensional
 Calibro per Implantologie / Tridimensionale
 Calibre para Implantología / Tridimensional
 Calibre pour Implantologie / Tridimensionnel

BONE BLOCK CLAMP

Bone Holding Clamps / Knochenhalteklammern / Daviers à os
 Pinzas de sujeción para hueso / Pinze per fissare l'osso

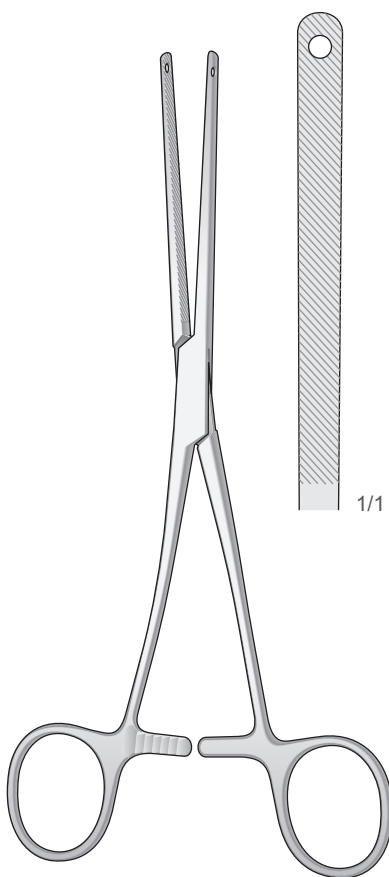

P-340
 220 mm

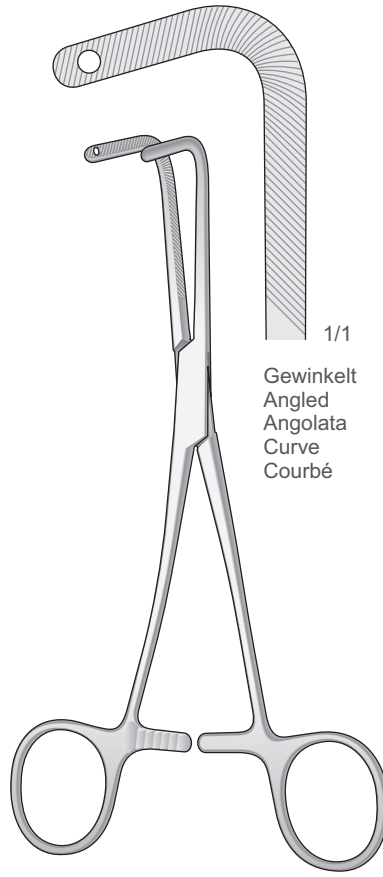

P-341
 200 mm

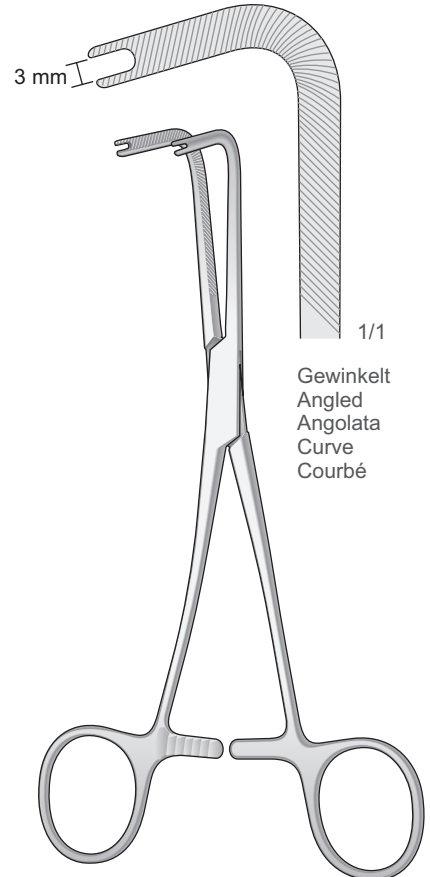

P-342
 200 mm

IMPLANTOLOGY

Bone Holding Forceps

Retraktoren - Knochenhaltezeuge
 Retractors - Bone Holding Forceps
 Divaricatori - Pinza per fissare l'osso
 Separadores - Pinzas para sujeción para hueso
 Écarteurs - Daviers à os

Tibia Wundspreizer
 Tibial and Iliac Retractor
 Divaricatore per tibia e cresta iliaca
 Separadores tibiales e iliacos
 Ecarteur pour tibia e crête iliaque

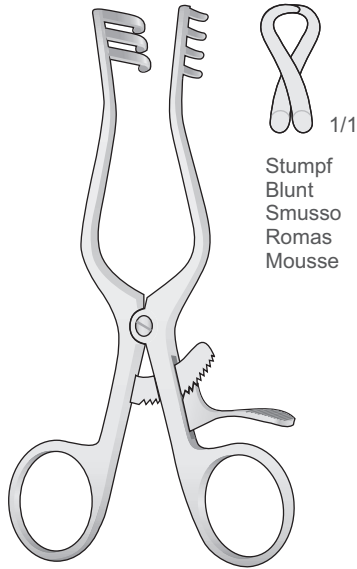

WEITLANER
BV-23
 165 mm

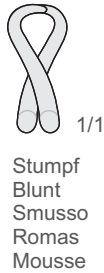

1/1
 Stumpf
 Blunt
 Smusso
 Romas
 Mousse

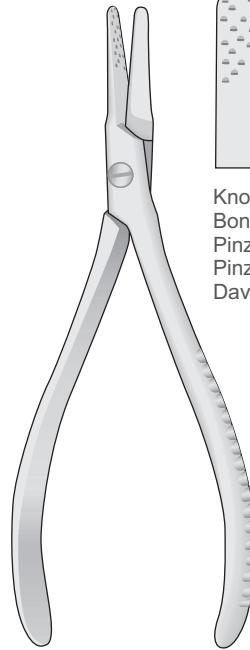

RADOLF
FO-159
 135 mm

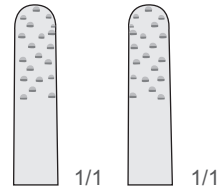

1/1 1/1
 Knochenhaltezeuge
 Bone Holding Forceps
 Pinza per fissare l'osso
 Pinzas de sujeción para hueso
 Davier à os

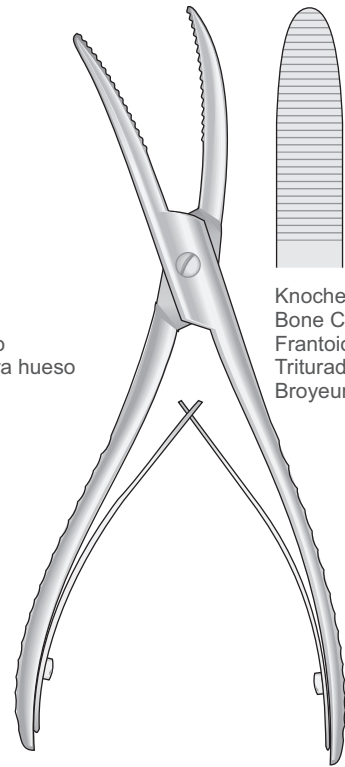

WOLFF
LX-113
 180 mm

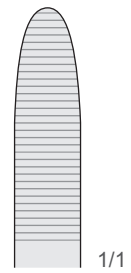

1/1
 Knochen-Quetsche
 Bone Crusher
 Frantoio per osso
 Triturador óseo
 Broyeur d'os

IMPLANTOLOGY

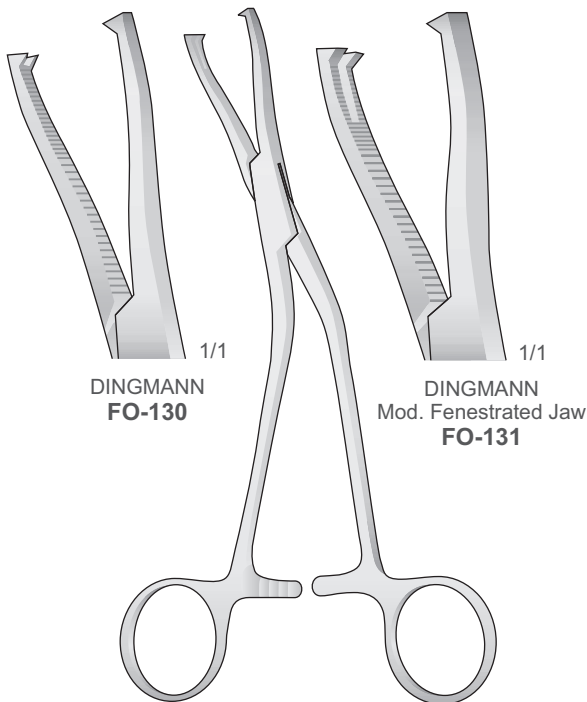

1/1
DINGMANN
FO-130

1/1
DINGMANN
 Mod. Fenestrated Jaw
FO-131

DINGMANN
FO-130/FO-131
 190 mm

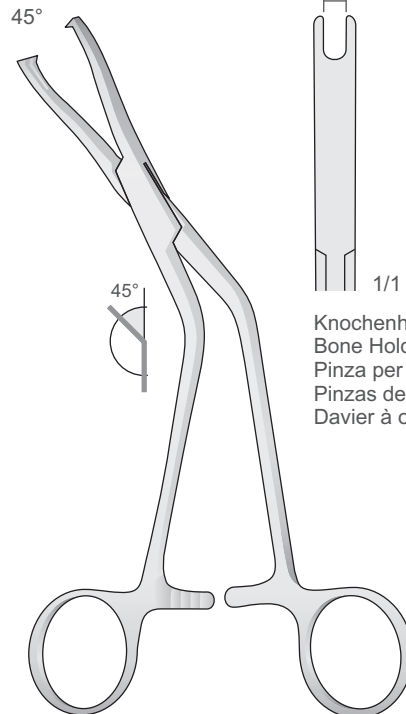

45°
DINGMANN - Mod. Fenestrated Jaw
FO-131S
 190 mm

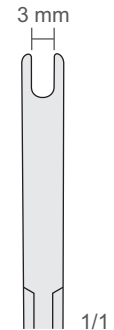

3 mm
 1/1
 Knochenhaltezeuge
 Bone Holding Forceps
 Pinza per fissare l'osso
 Pinzas de sujeción para hueso
 Davier à os

• Periosteals / Curettes / Bone

223 | Periosteal Elevators

232 | Curettes

238 | Bone Files

240 | Tissue Nippers

241 | Bone Rongeurs

246 | Bone Cutting Forceps



Raspatorien
 Periosteals (Raspatories)
 Scollaperiosteai (Periostotomi)
 Periostótomos (Legras)
 Rugines périostiques

Periosteal Elevators

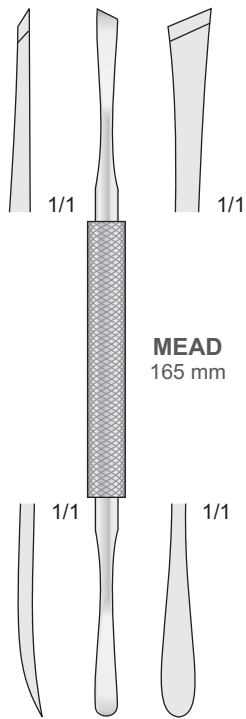

MEAD
165 mm

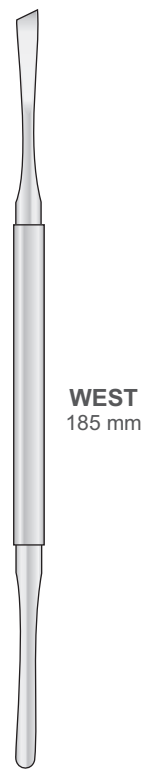

WEST
185 mm

PERIOSTEAL ELEVATORS

Scharf - Sharp - Taglienti - Cortante - Tranchant

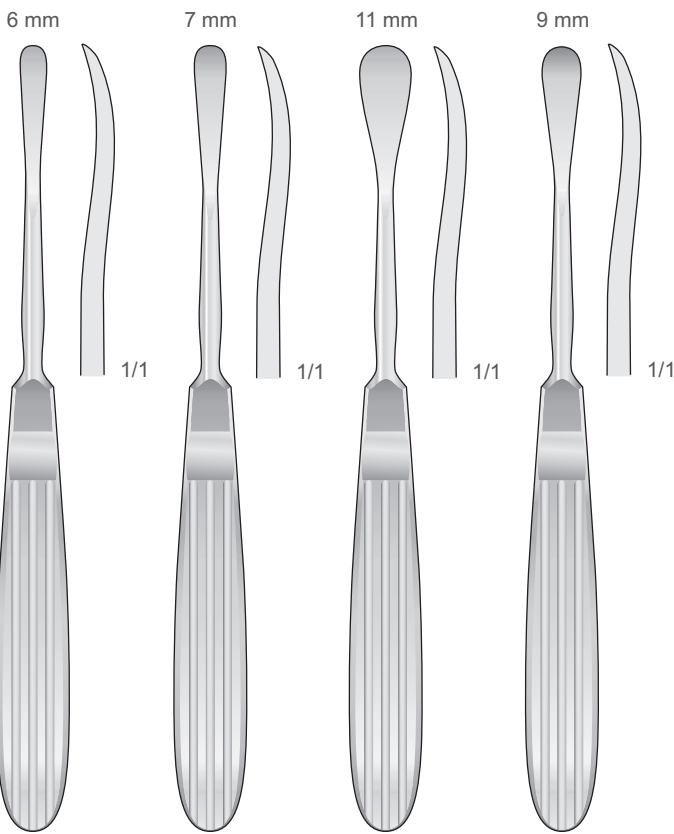

OBWEGESER
DO-59
175 mm

OBWEGESER
DO-63
175 mm

OBWEGESER
DO-65
175 mm

OBWEGESER
DO-67
175 mm

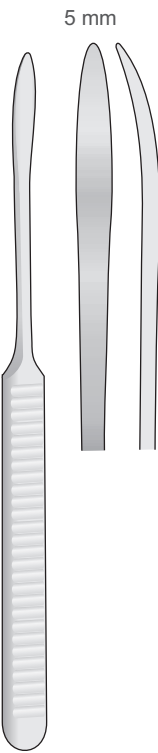

WILLIGER
WG-10
165 mm

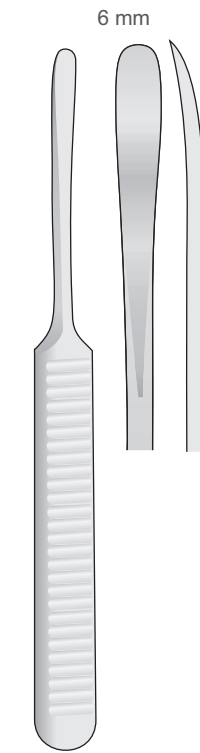

WILLIGER
WG-12
160 mm

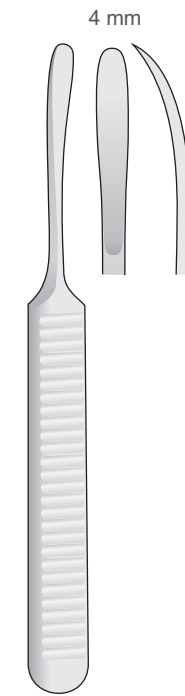

WILLIGER
WG-14
140 mm

PERIOSTEALS,
CURETTES & BONE

Raspatorien
 Periosteals (Raspatories)
 Scollaperiostei (Periostotomi)
 Periostótomos (Legras)
 Rugines périostiques

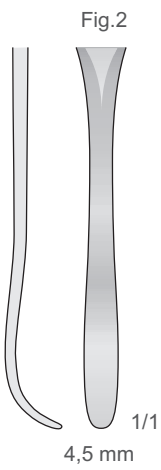
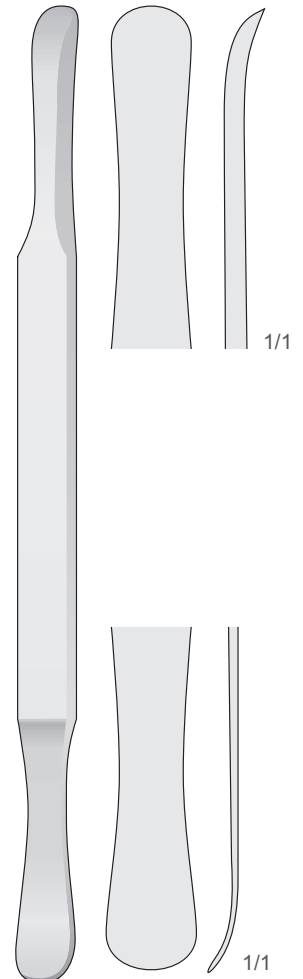
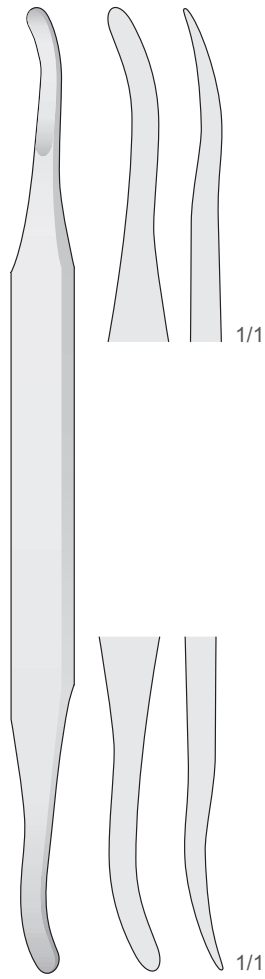
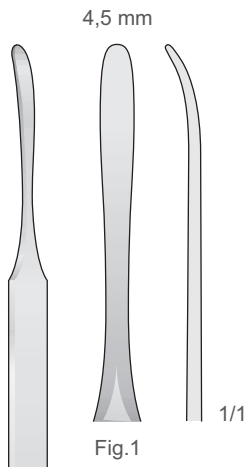
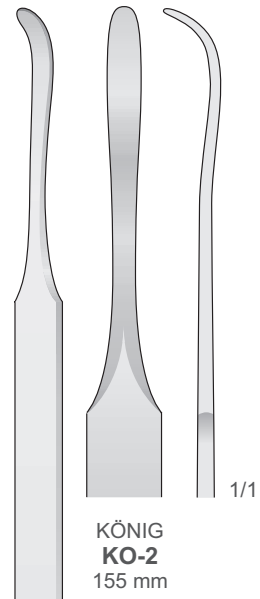
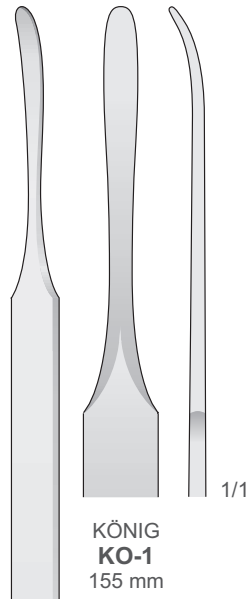

**KÖNIG
 KO-3
 210 mm**

**SELDIN
 KO-22
 190 mm**

**SELDIN
 KO-23
 195 mm**

PERIOSTEALS,
 CURETTES & BONE

Raspatorien - Elevatorien
 Raspatories - Elevators
 Periostotomi - Elevatori
 Legras - Elevadores
 Rugines - Elevateurs

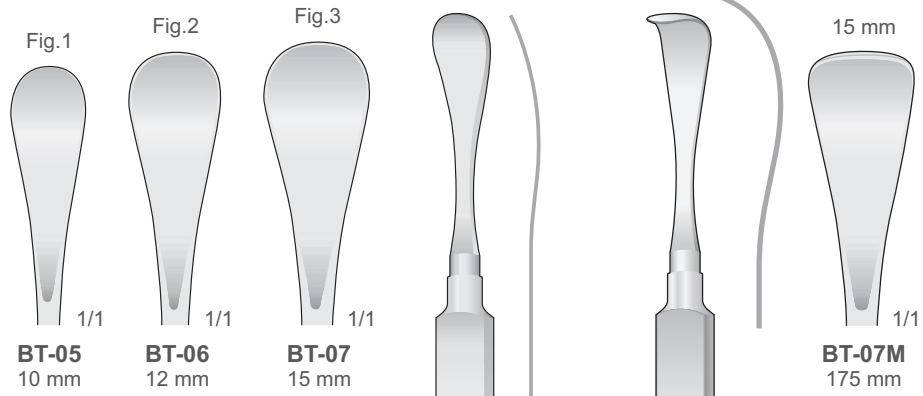

Halbscharf
 Semi-Scharp
 Semitagliente
 Semicortante
 Semitranchant

HENAHAN
 BT-05/BT-07
 175 mm

HENAHAN
 BT-07M
 175 mm

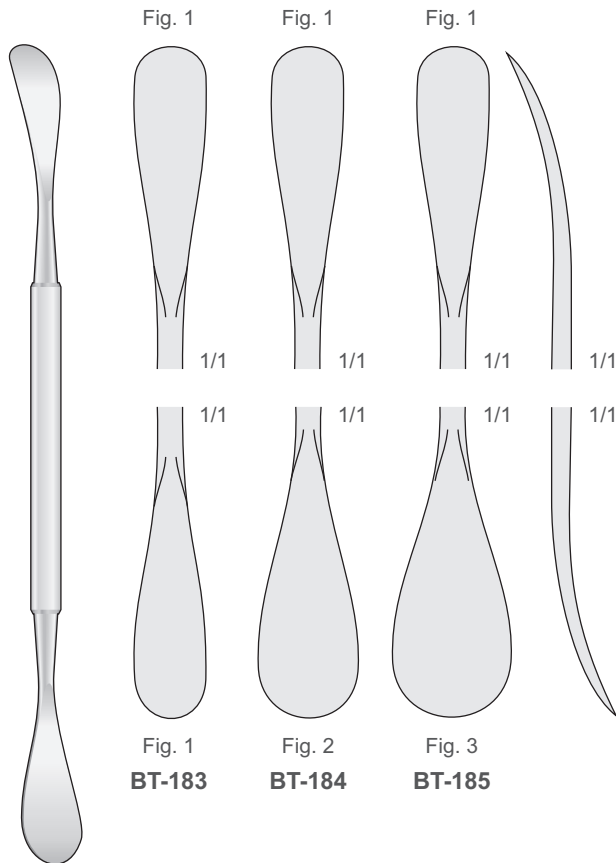

HENAHAN
 BT-183/BT-185
 200 mm

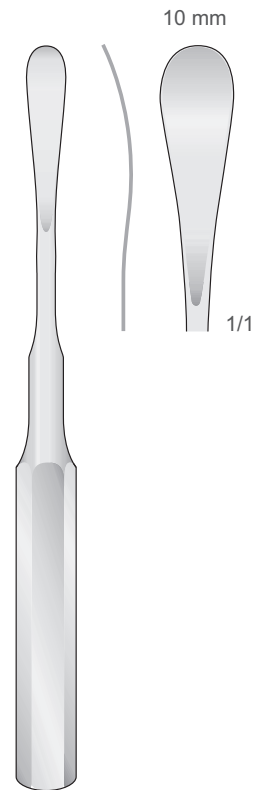

MOLT
 MO-15
 160 mm

PERIOSTEALS,
 CURETTES & BONE

Fig. 12S

PERIOSTEALS,
 CURETTES & BONE

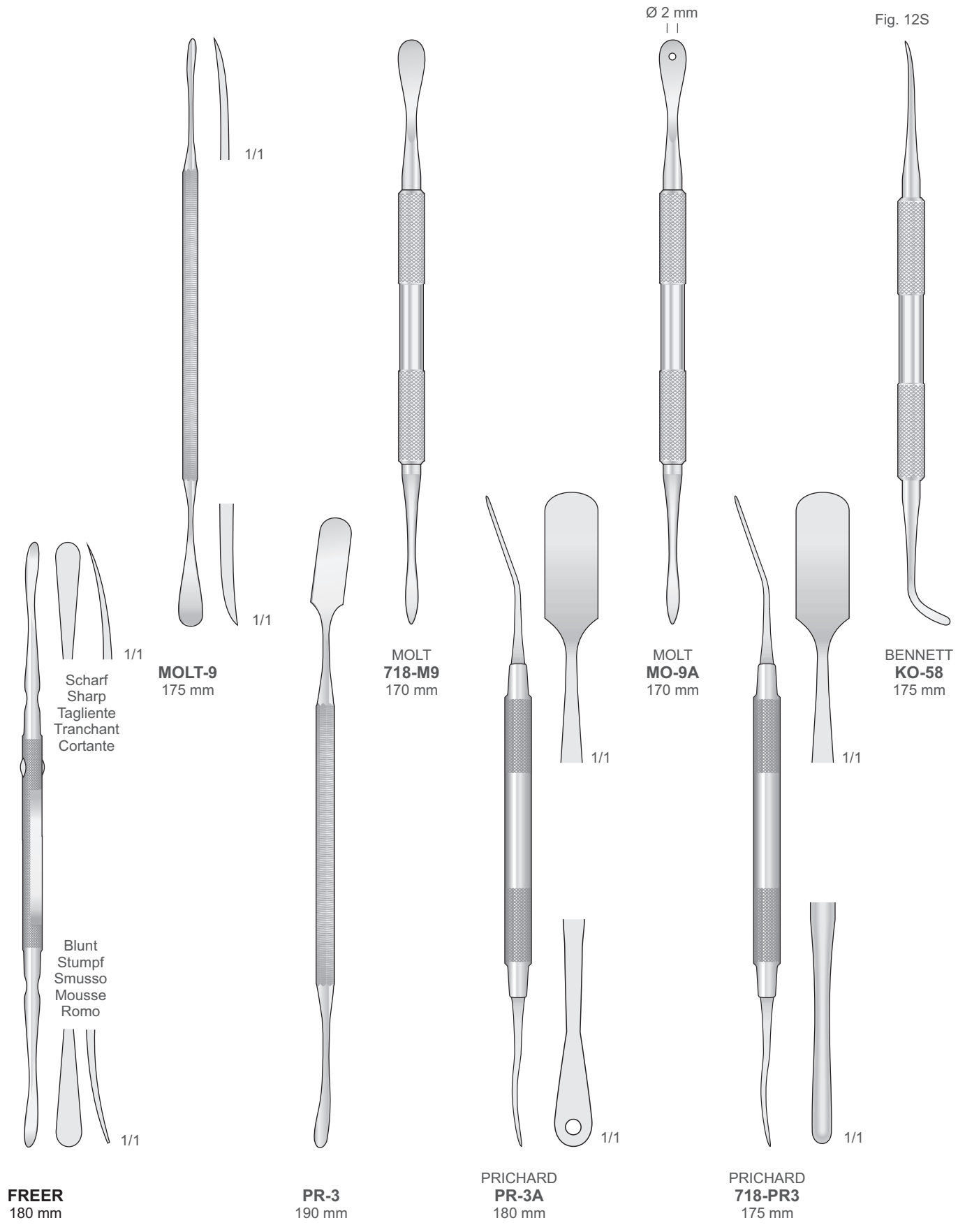

Raspatorien - Elevatorien
 Raspatories - Elevators
 Periostotomi - Elevatori
 Legras - Elevadores
 Rugines - Elevateurs

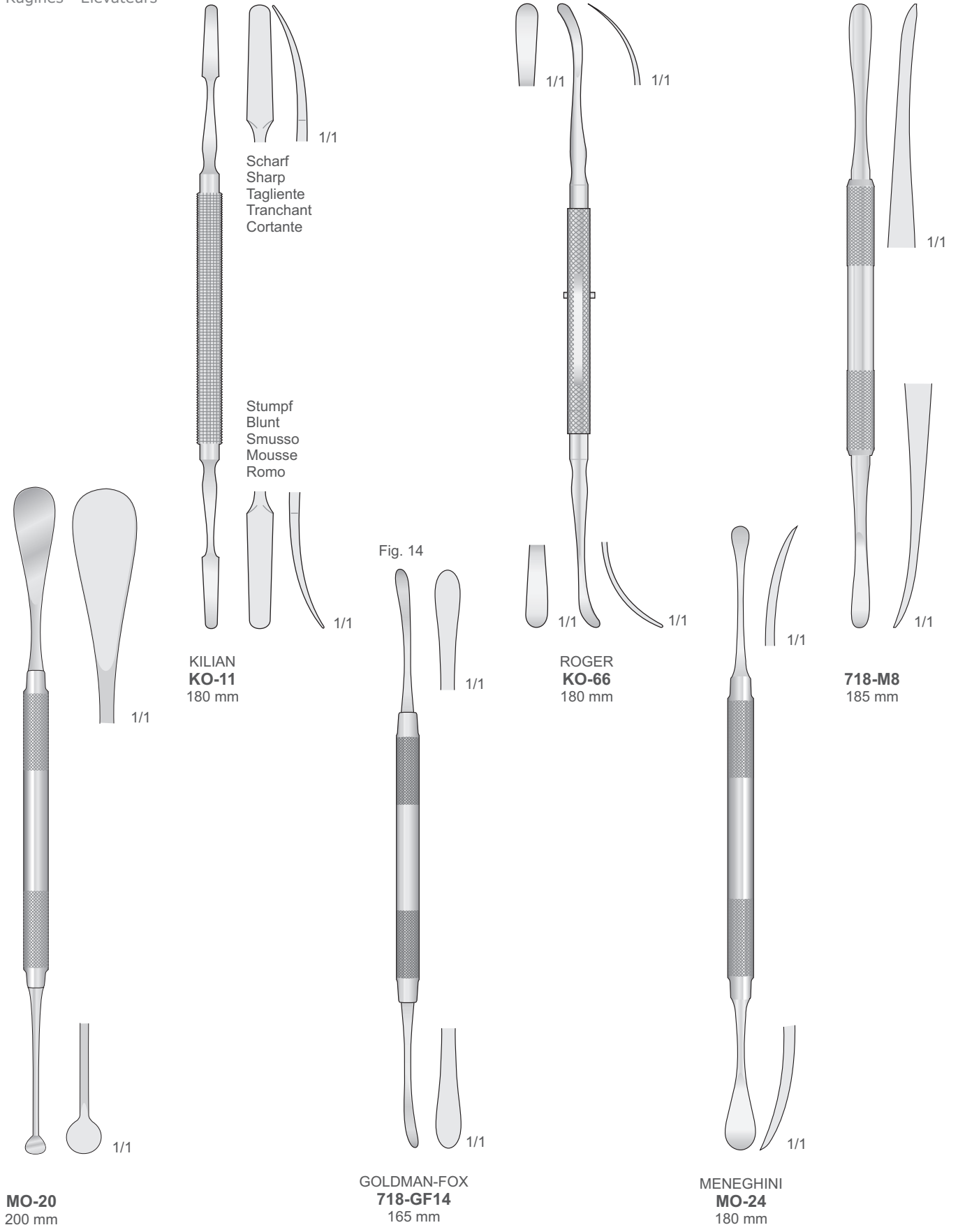

Scharf
 Sharp
 Tagliente
 Tranchant
 Cortante

Stumpf
 Blunt
 Smusso
 Mousse
 Romo

Fig. 14

MO-20
200 mm

**KILIAN
KO-11**
180 mm

**ROGER
KO-66**
180 mm

718-M8
185 mm

**GOLDMAN-FOX
718-GF14**
165 mm

**MENEGHINI
MO-24**
180 mm

PERIOSTEALS,
CURETTES & BONE

Raspatorien - Elevatorien
 Raspatories - Elevators
 Periostotomi - Elevatori
 Legras - Elevadores
 Rugines - Elevateurs

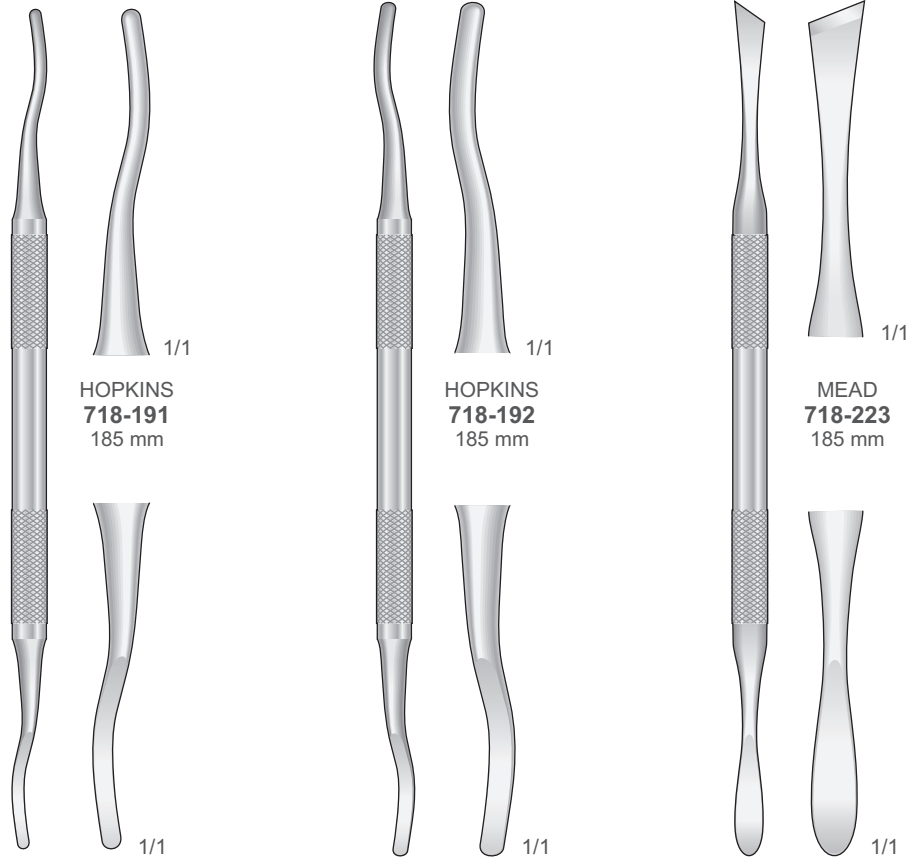

Instrumente für Sinuslift / Sinus Lift Instruments / Strumenti per rialzo del seno
 Instrumentos para elevación de seno maxilar / Instruments d'élévation sinusienne

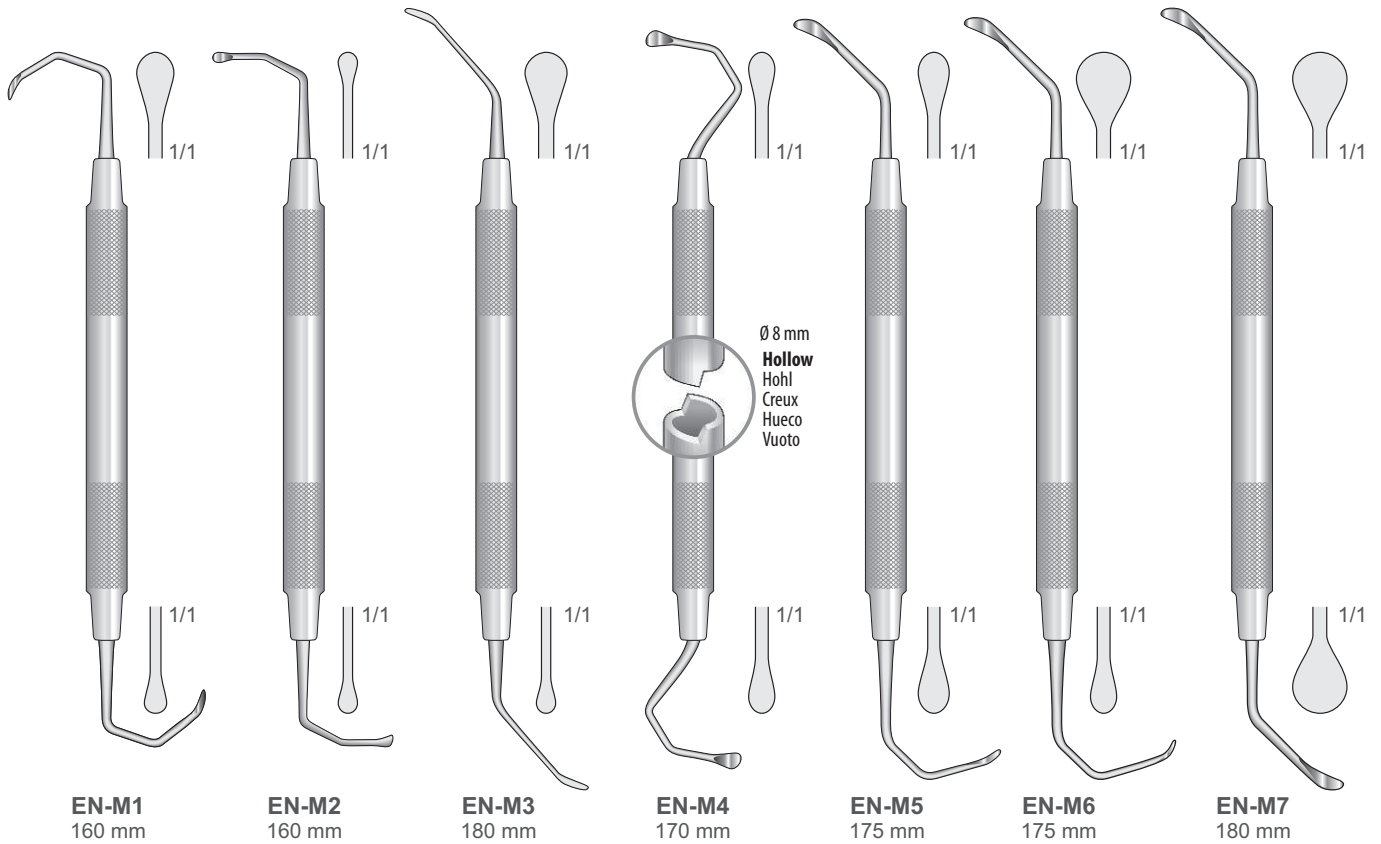

PERIOSTEALS,
 CURETTES & BONE

Raspatorien - Elevatorien
 Raspatories - Elevators
 Periostotomi - Elevatori
 Legras - Elevadores
 Rugines - Elevateurs

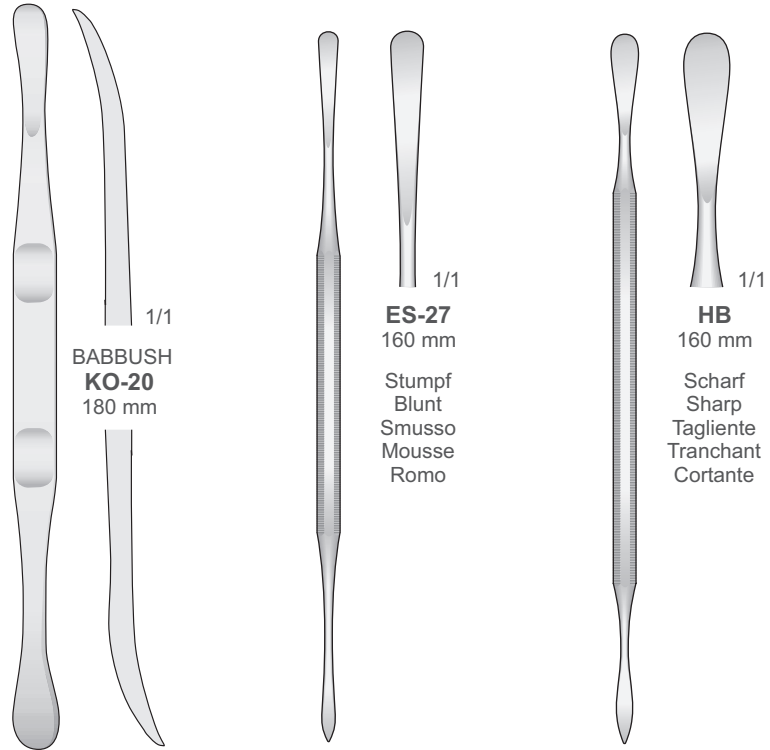
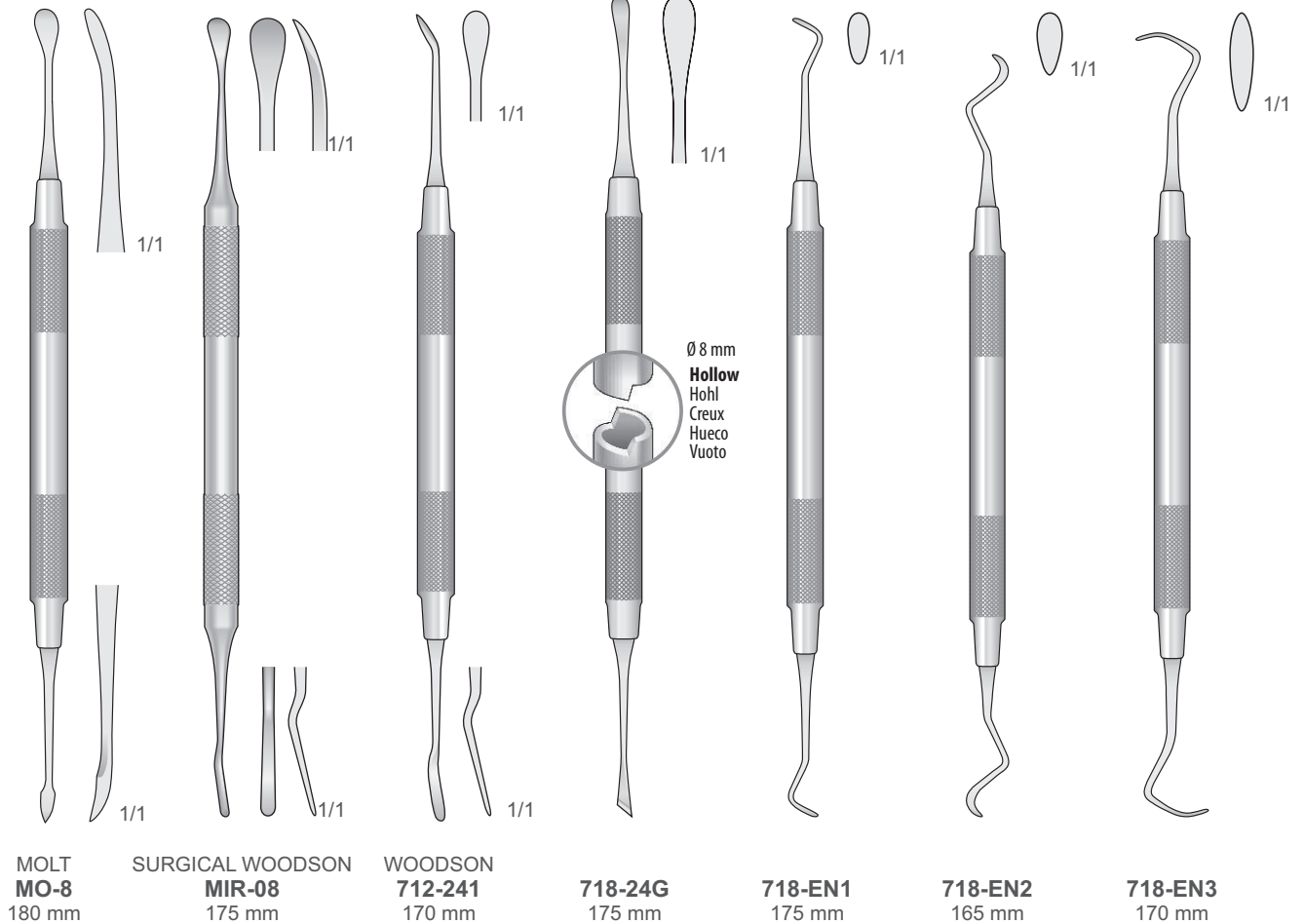

Fig. 24G

Instrumente für Sinuslift
 Sinus Lift Instruments
 Strumenti per rialzo del seno
 Instrumentos para elevación de seno maxilar
 Instruments d'élevation sinusienne



PERIOSTEALS,
 CURETTES & BONE

Raspatorien - Elevatorien
 Raspatories - Elevators
 Periostotomi - Elevatori
 Legras - Elevadores
 Rugines - Elevateurs

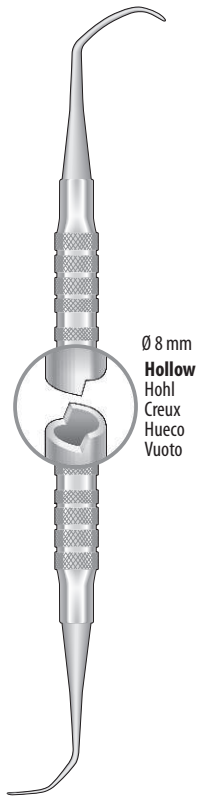

Ø 8 mm
Hollow
 Hohl
 Creux
 Hueco
 Vuoto

TASO-1

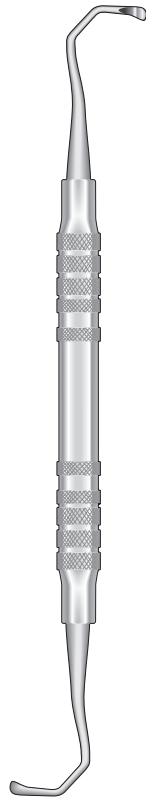

TASO-2



TASO-3

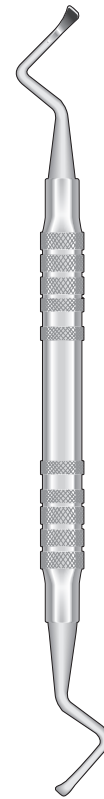

TASO-4

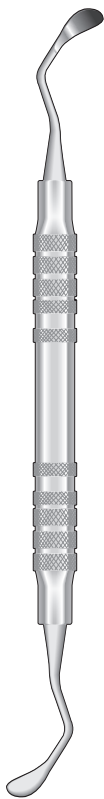

TASO-5



TASO-6



TASO-7



Ø 8 mm
Hollow
 Hohl
 Creux
 Hueco
 Vuoto

TASO-8

PERIOSTEALS,
 CURETTES & BONE

Curettes
 Küretten
 Curettes
 Curetas
 Curettes

Instrumente für Sinuslift
 Sinus Lift Instruments
 Strumenti per rialzo del seno
 Instrumentos para elevación de seno maxilar
 Instruments d'élevation sinusienne

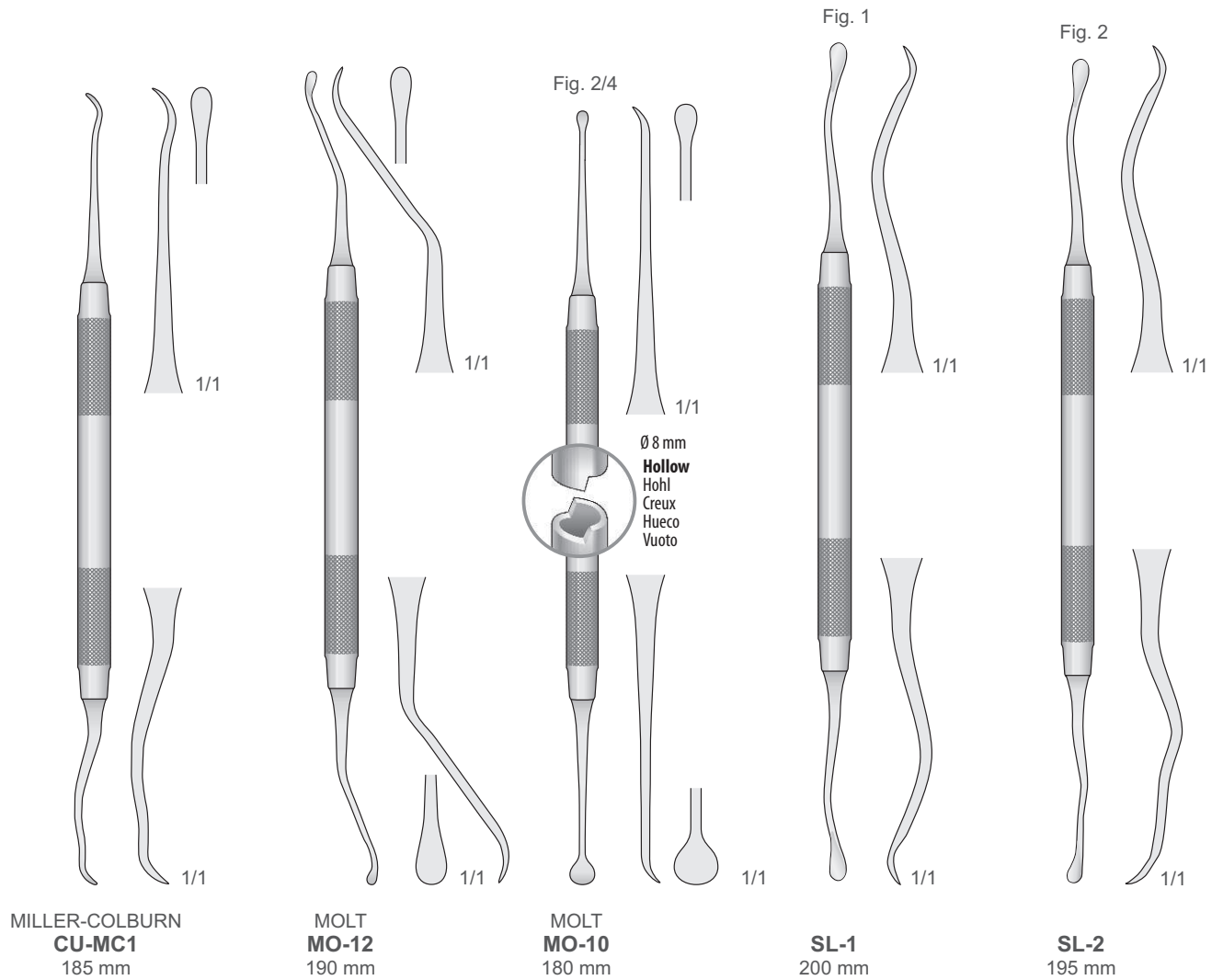

Curettes

Küretten
Curettes
Curettes
Curetas
Curettes

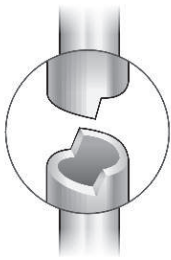

Runder Hohlgriff 8 mm
Hollow Round Handle 8 mm
Manico tondo vuoto 8 mm
Mango hueco 8 mm
Manche rond vide 8 mm

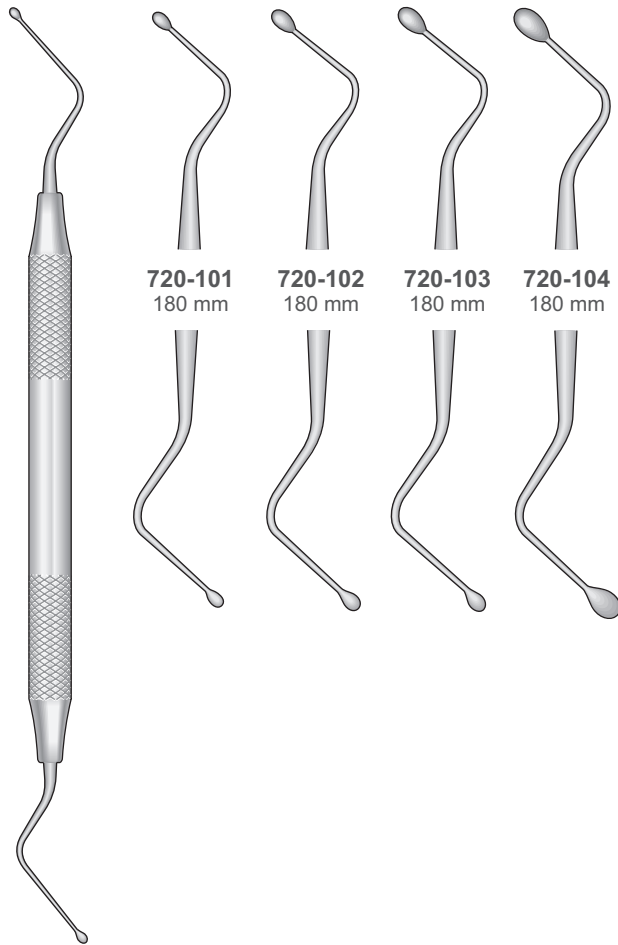

720-101
180 mm

720-102
180 mm

720-103
180 mm

720-104
180 mm

HEMINGWAY
720-101/720-104
180 mm

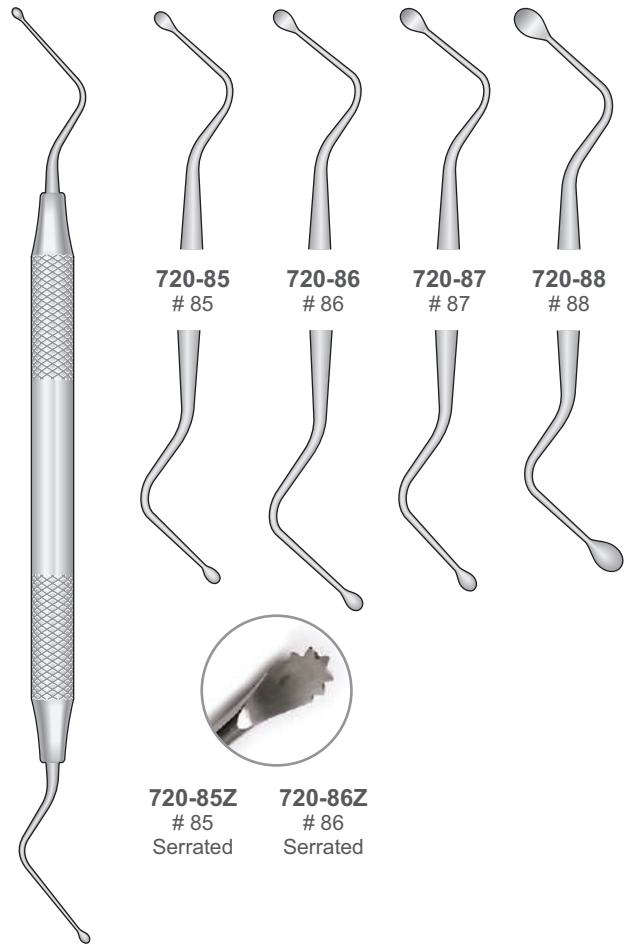

720-85
85

720-86
86

720-87
87

720-88
88



720-85Z
85
Serrated

720-86Z
86
Serrated

LUCAS
720-85/720-88
180 mm

PERIOSTEALS,
CURETTES & BONE

Küretten
Curettes
Curettes
Curetas
Curettes

Wundhachen Mandibular
Mandibular Nerve Diplace
Per spostamento
nervo mandibolare
Para nero mandibular

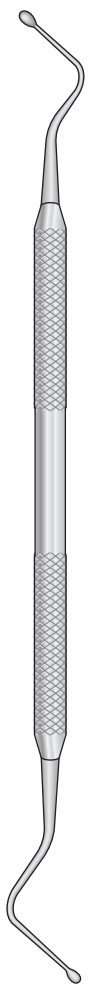

HEMINGWAY
C-1
170 mm

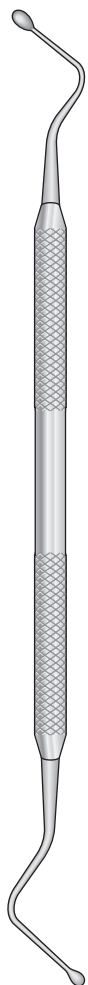

HEMINGWAY
C-2
170 mm

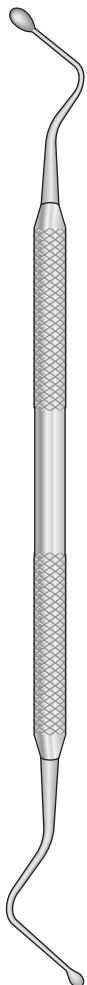

HEMINGWAY
C-3
170 mm

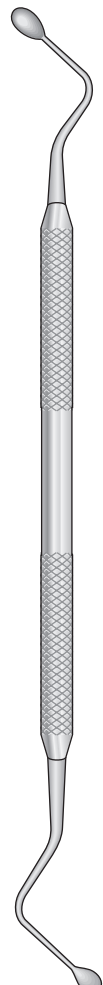

HEMINGWAY
C-4
170 mm

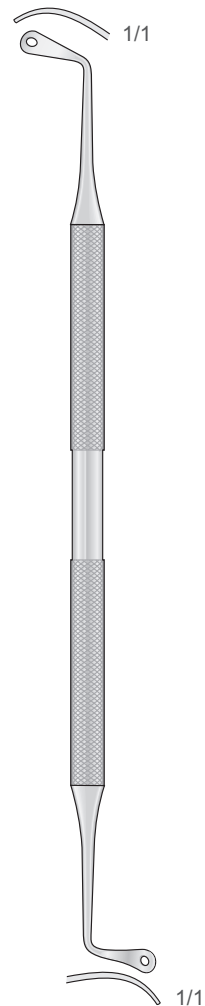

SL-21
165 mm

PERIOSTEALS,
CURETTES & BONE

Küretten
Curettes
Curettes
Curetas
Curettes

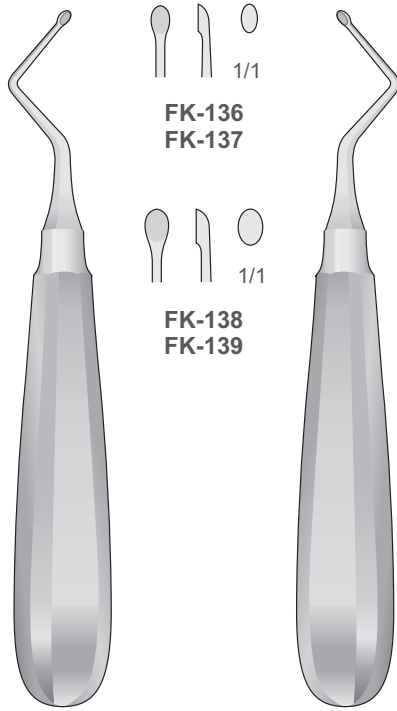

KERPEL
FK-136
FK-138
145 mm

KERPEL
FK-137
FK-139
145 mm



DL-50
155 mm

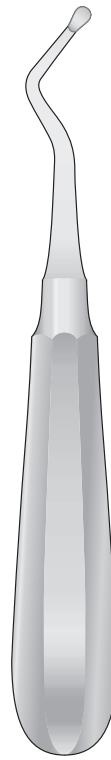

DL-51
150 mm

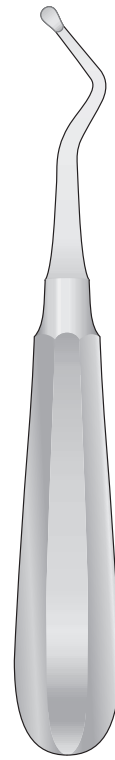

DL-52
150 mm

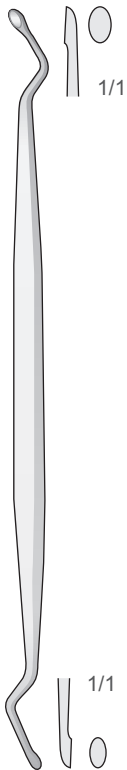

FK-83
160 mm

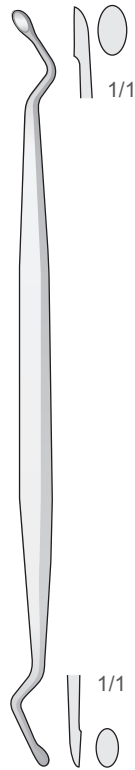

JANSEN
FK-84
160 mm



UFFENDORDE
FK-188
170 mm

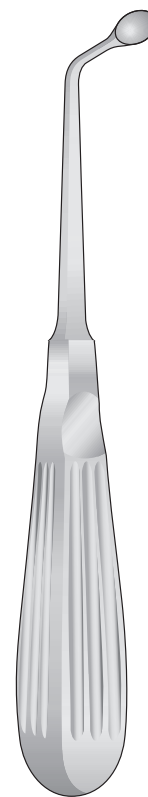

UFFENDORDE
FK-189
170 mm



WILLIGER
FK-197/FK-198
170 mm

Fig. 00
3,4 mm
1/1
FK-197
Fig. 1
5,2 mm
1/1
FK-198

PERIOSTEALS,
CURETTES & BONE

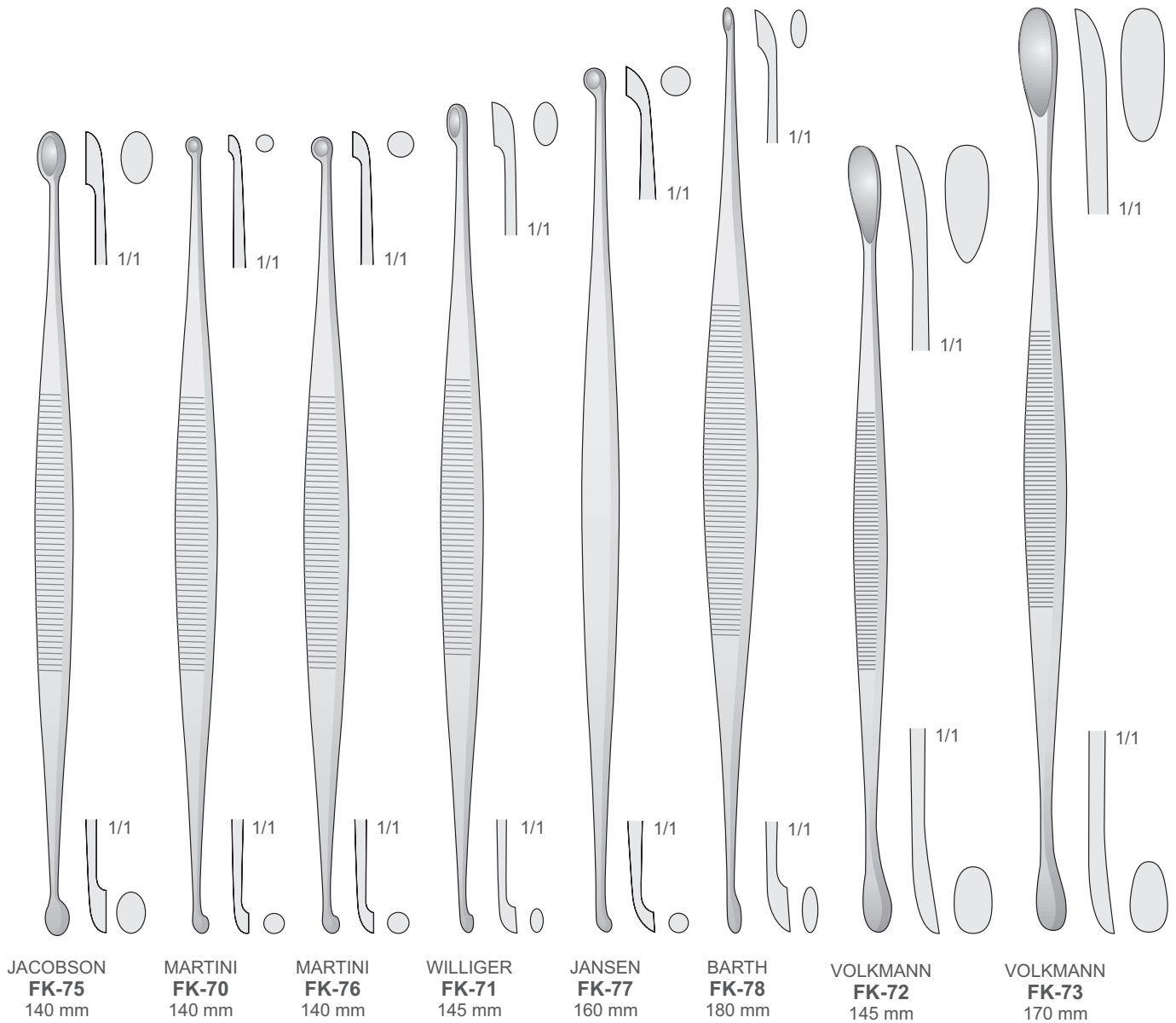

Küretten
Curettes
Curettes
Curetas
Curettes

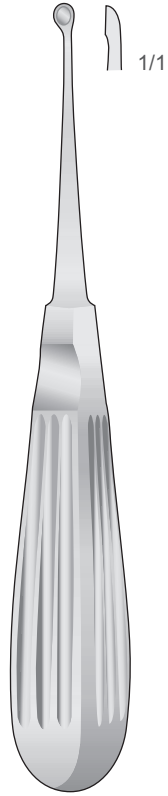

VOLKMANN
FK-60/FK-67
170 mm

Fig.0000
2,8 mm
1/1
FK-60

Fig.000
3,6 mm
1/1
FK-61

Fig.00
4,4 mm
1/1
FK-62

,Fig.0
5,2 mm
1/1
FK-63

Fig.1
6,8 mm
1/1
FK-64

Fig.2
8,5 mm
1/1
FK-65

Fig.3
10 mm
1/1
FK-66

Fig.4
11,5 mm
1/1
FK-67

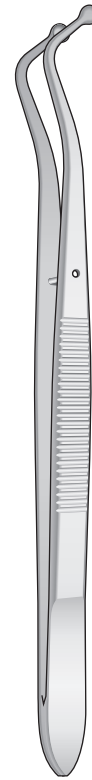

COLLEGE
CURETTE
MIR-10
160 mm

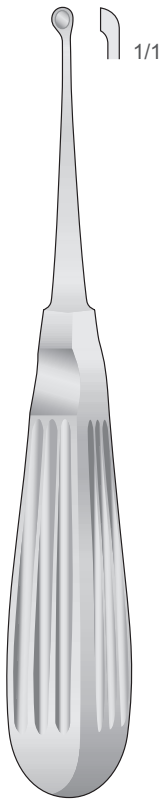

BRUNS
FK-110/FK-116
165 mm

3 mm FK-110	4 mm FK-111	5 mm FK-112
6 mm FK-113	8 mm FK-114	
10 mm FK-115	12 mm FK-116	

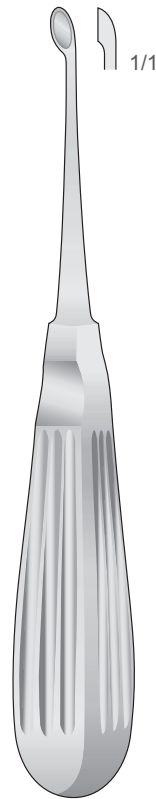

SCHIDE
FK-120/FK-126
170 mm

2,5 mm FK-120	3,4 mm FK-121	4,2 mm FK-122
5,2 mm FK-123		6,3 mm FK-124
7,4 mm FK-125		8 mm FK-126

PERIOSTEALS,
CURETTES & BONE

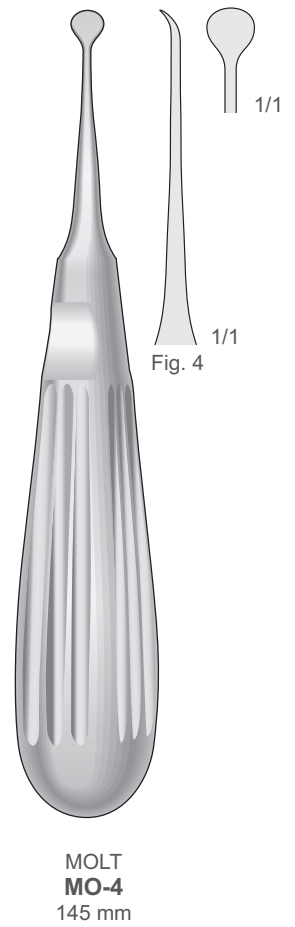
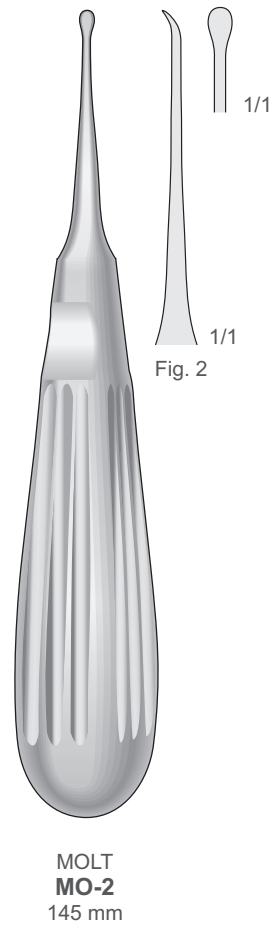
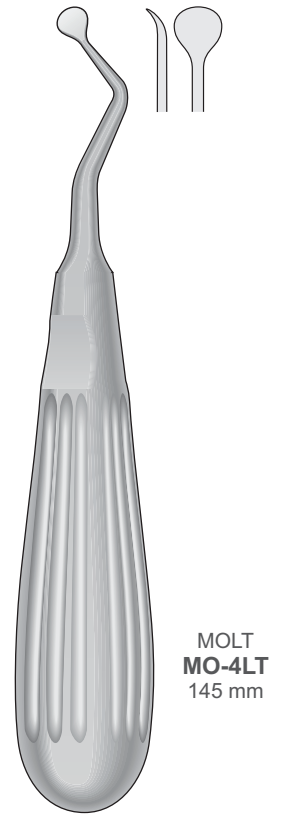
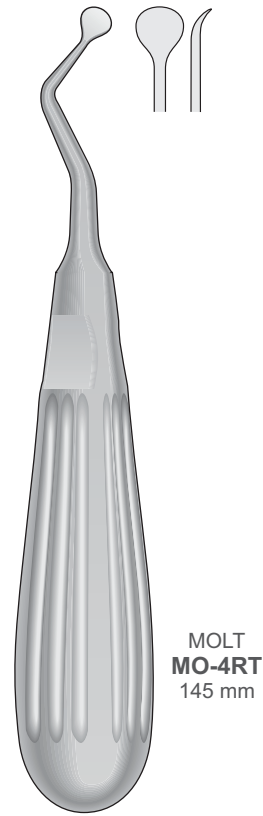
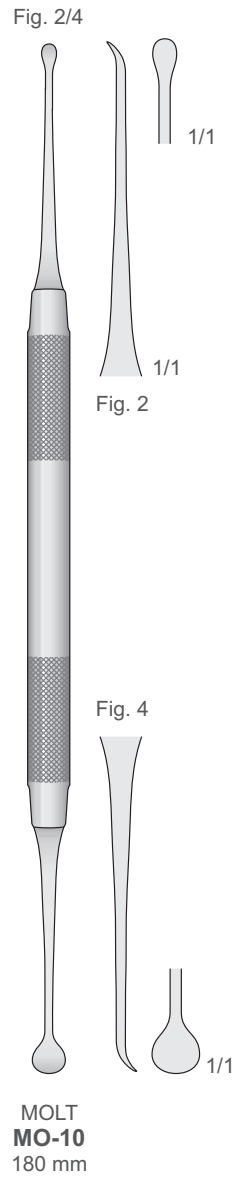
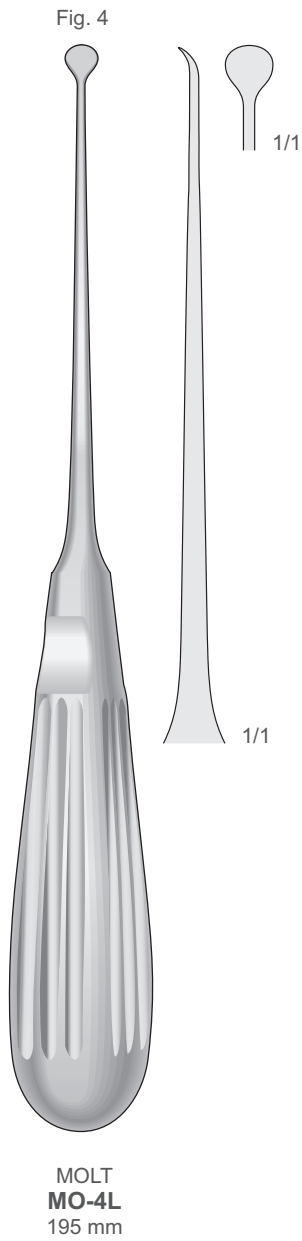

PERIOSTEALS,
 CURETTES & BONE

Fig. 67

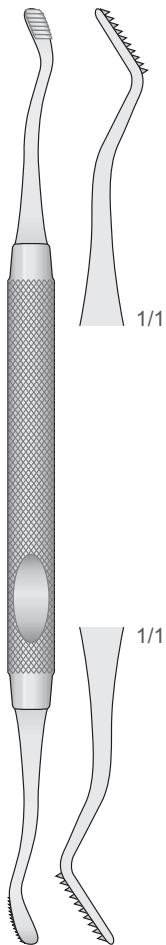

HOWARD
DO-1
180 mm

Fig. 45

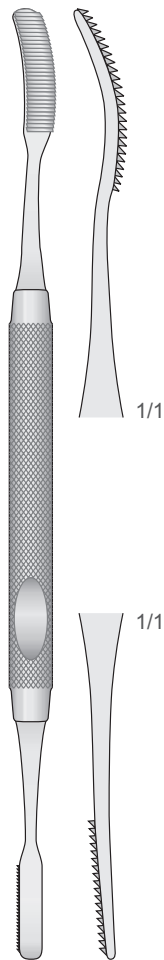

MILLER
DO-2
185 mm

Fig. 52

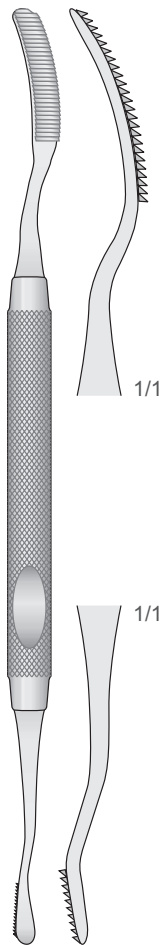

MILLER
DO-3
180 mm

Fig. 12

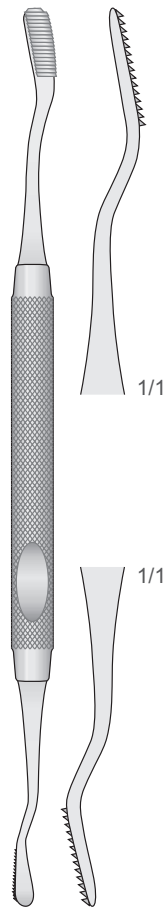

HOWARD
DO-4
170 mm

Fig. 12A

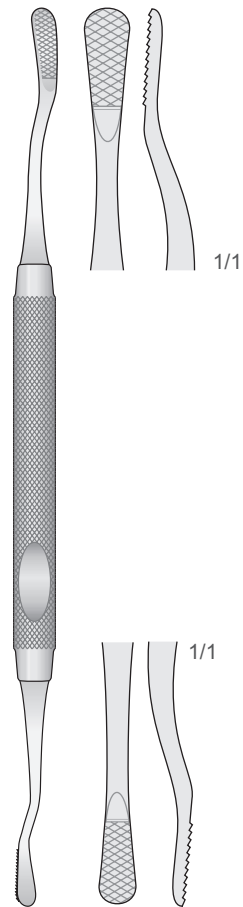

MILLER
DO-4C
170 mm

Fig. 64

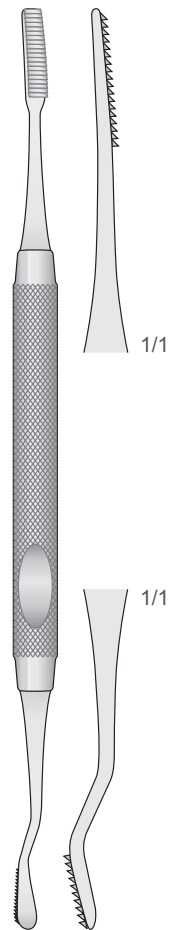

MILLER
DO-5
175 mm

Knochenfeilen
 Bone Files
 Lime per osso
 Limas para hueso
 Limes à os

Runder Hohlgriff 8 mm
 Hollow Round Handle 8 mm
 Manico tondo vuoto 8 mm
 Mango hueco 8 mm
 Manche rond vide 8 mm

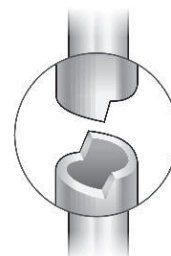

Parodontal Feilen
 Periodontal Files
 Lime parodontali
 Limas periodontales
 Limes parodontales

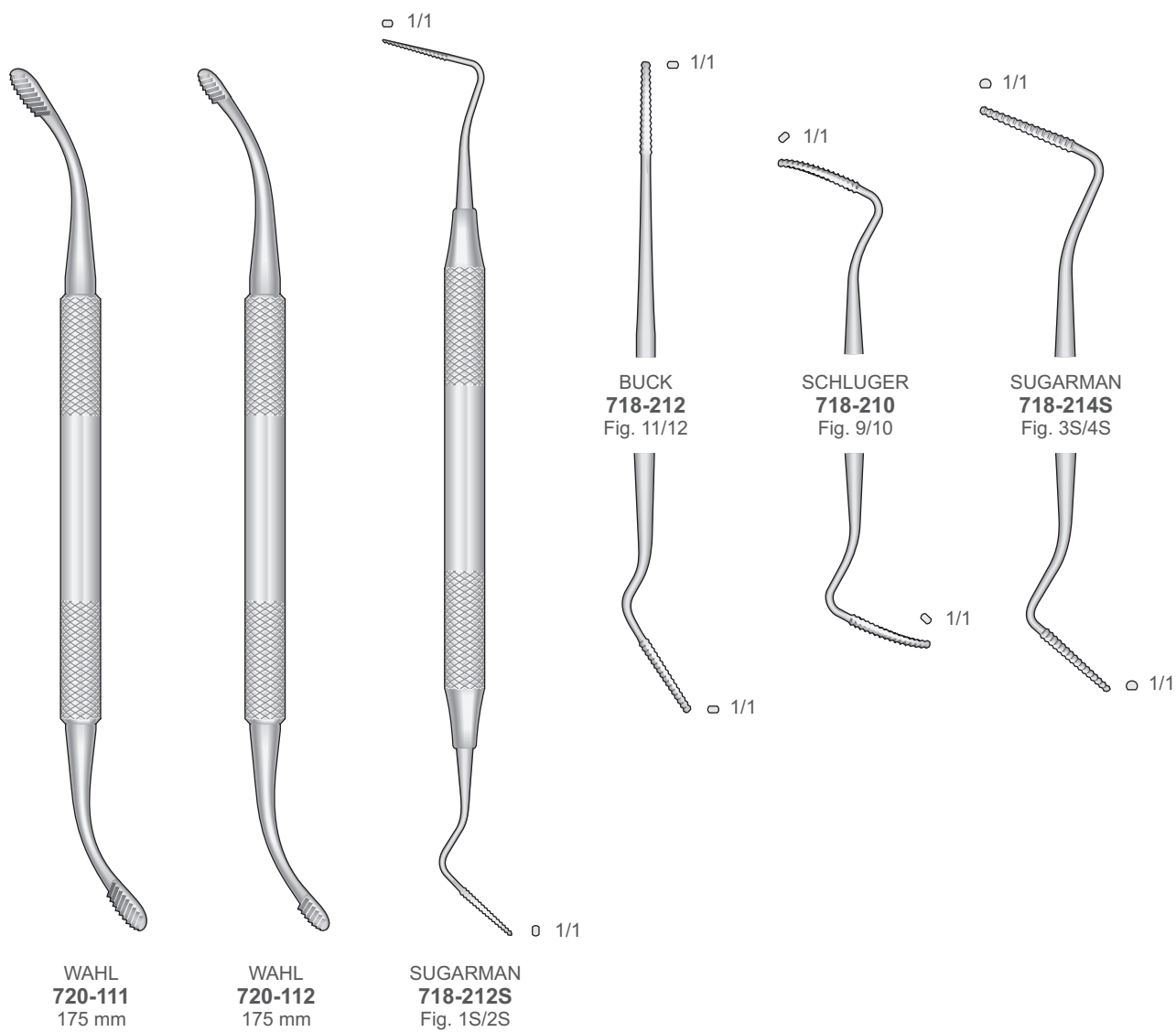

PERIOSTEALS,
 CURETTES & BONE

Tissue Nippers

Gewebezängchen
Tissue Nippers
Tronchesi per gengive e tessuti
Pinzas para cortar tejidos
Pinces coupante pour tissue

PERIOSTEALS,
CURETTES & BONE

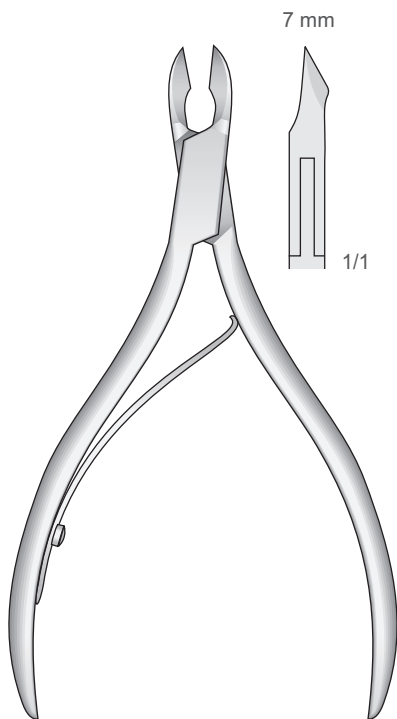

CHOEN
LX-60
105 mm

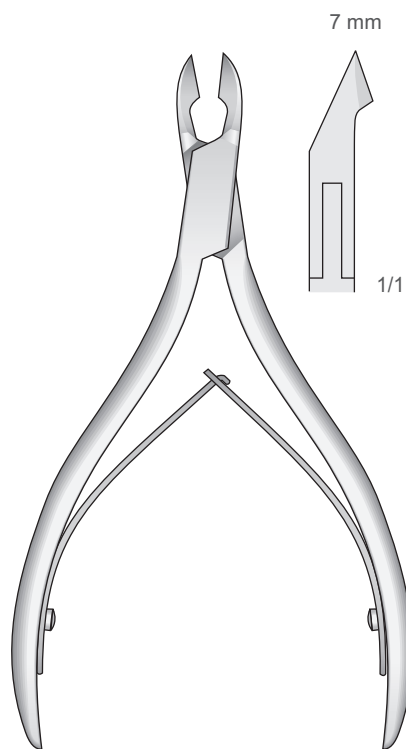

ILIC
LX-50
115 mm

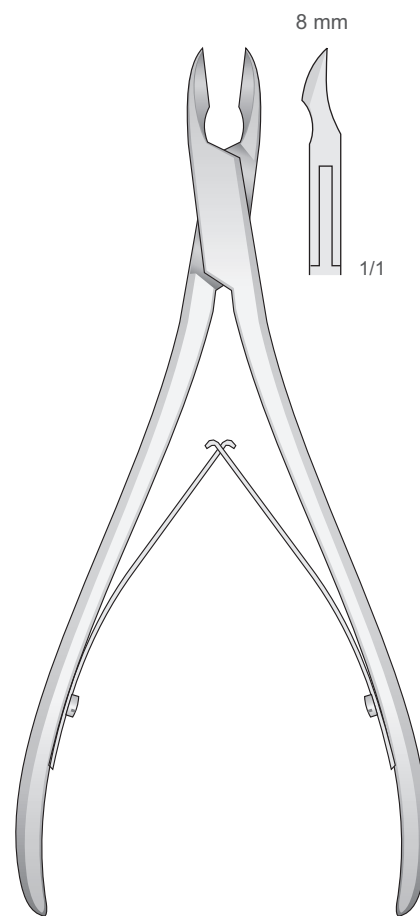

LX-52
140 mm

Hohlmeißelzangen
 Bone rongeurs
 Pinze ossivore
 Pinzas gubias
 Pincas gouges

Bone Rongeurs

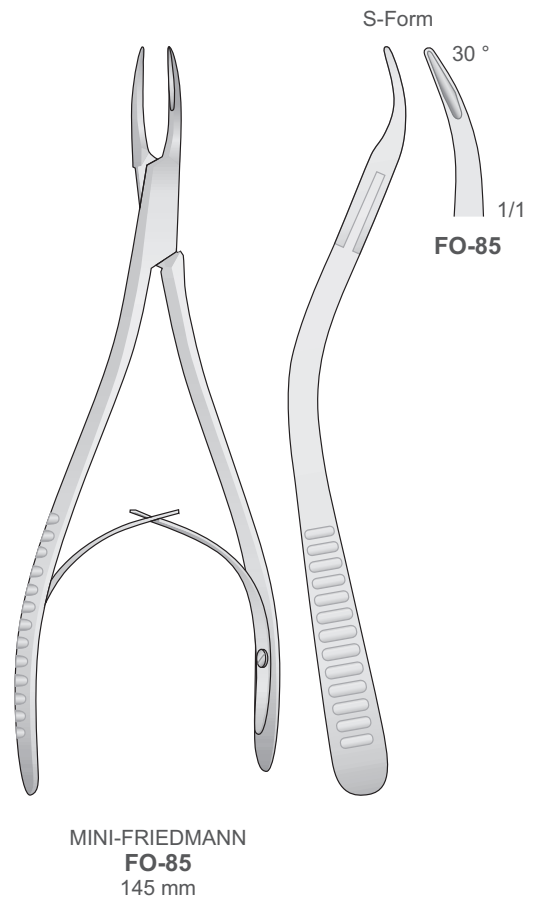
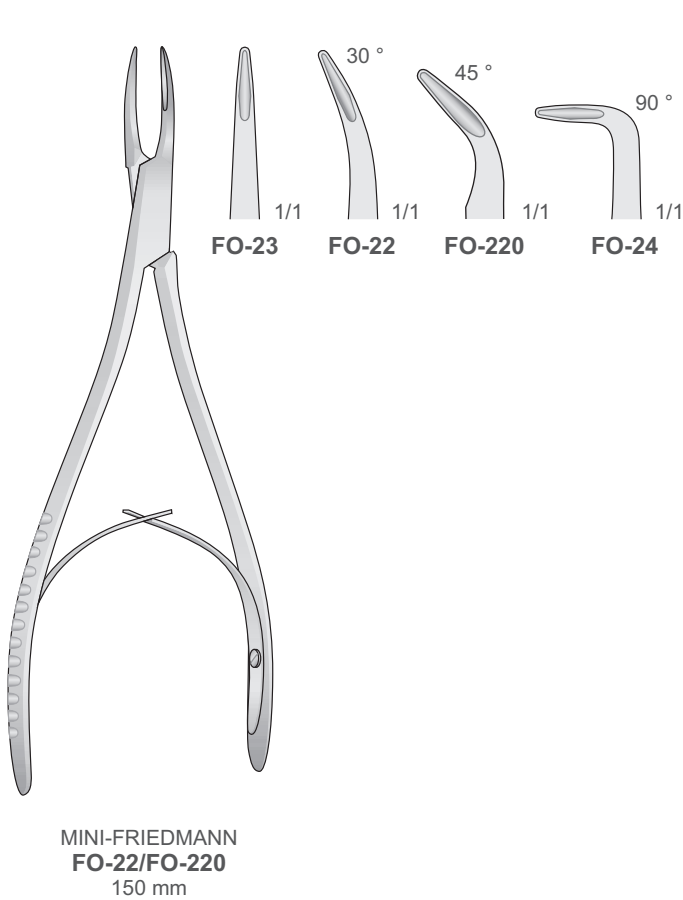
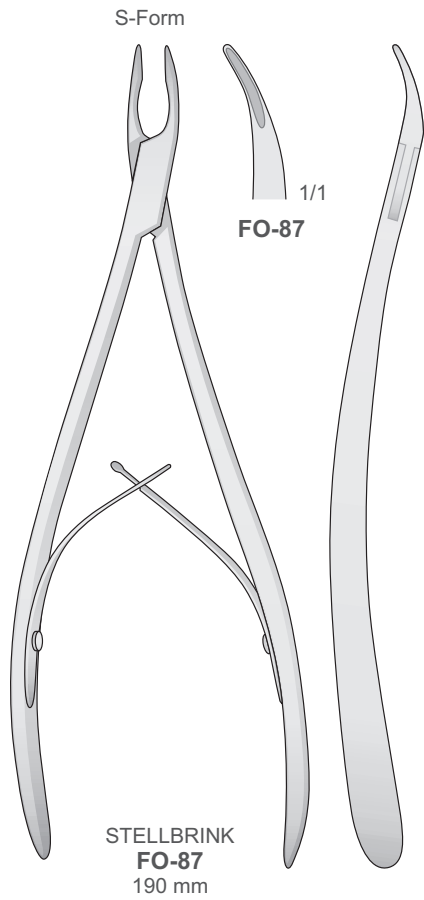

PERIOSTEALS,
 CURETTES & BONE

Hohlmeißelzangen
 Bone rongeurs
 Pinze ossivore
 Pinzas gubias
 Pincas gouges

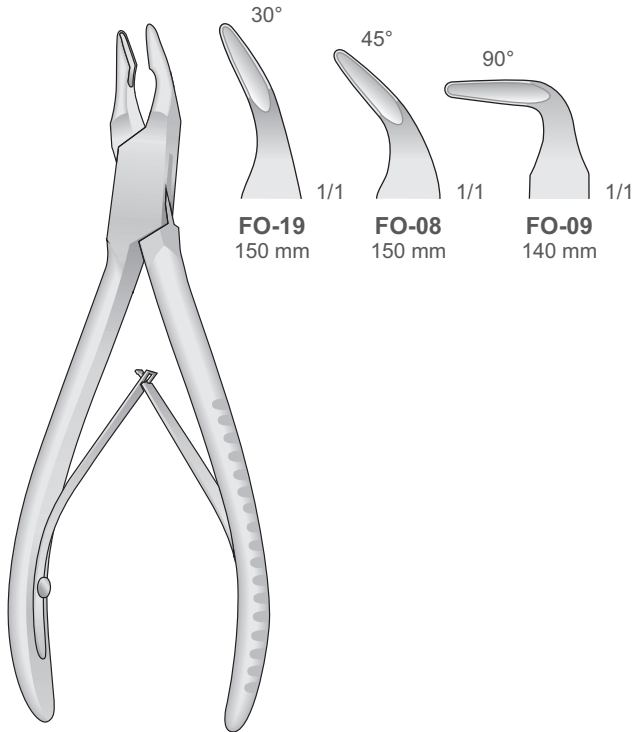

BLUMENTHAL
FO-08/FO-19

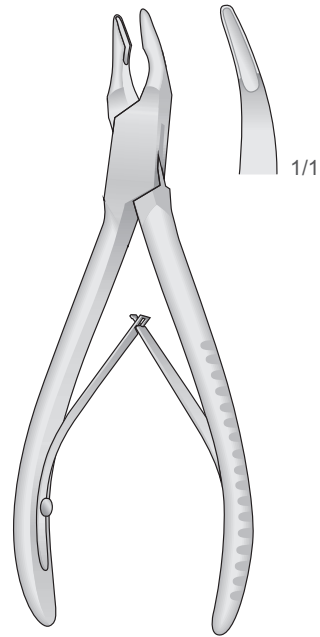

MINI FRIEDMAN
FO-15
 120 mm

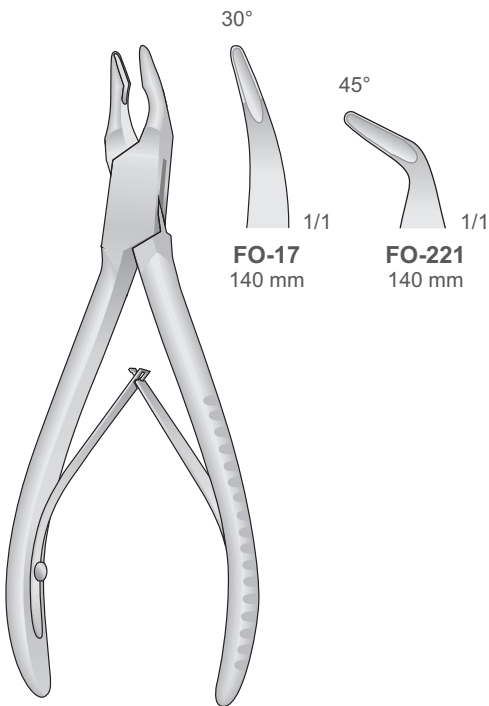

FRIEDMANN
FO-17/FO-221
 140 mm

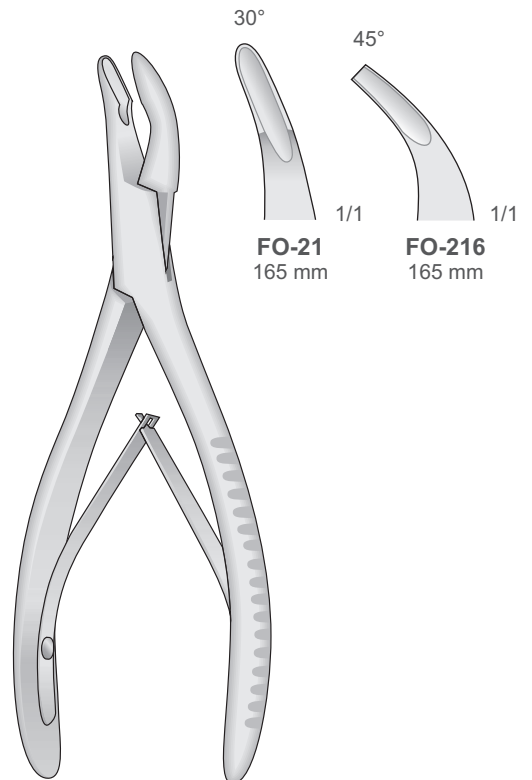

MEAD
FO-21/FO-216
 165 mm

PERIOSTEALS,
 CURETTES & BONE

Hohlmeißelzangen
Bone rongeurs
Pinze ossivore
Pinzas gubias
Pincas gouges

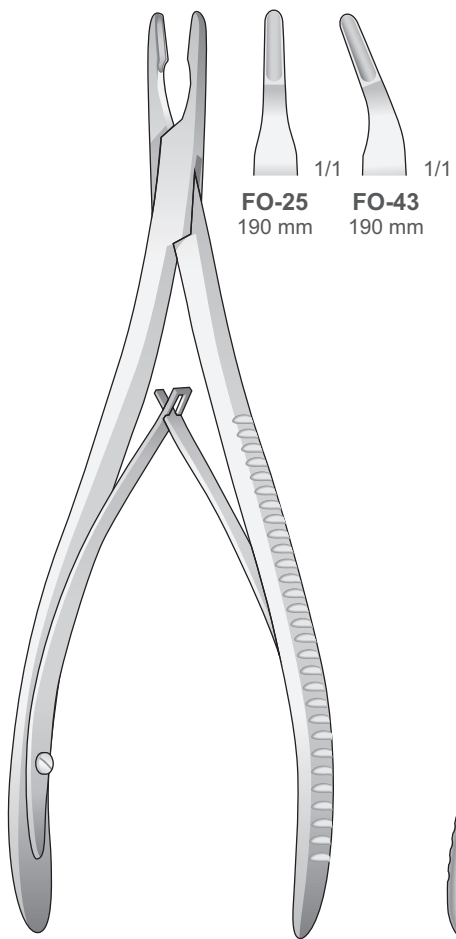

LEMPERT
FO-25/FO-43
190 mm

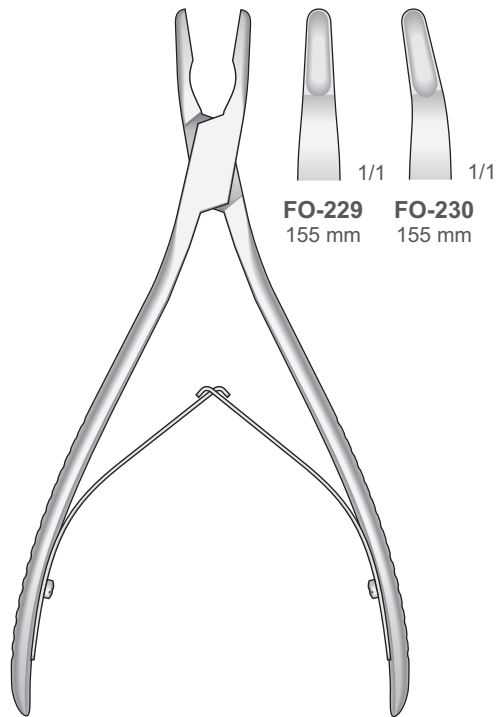

LEMPERT
FO-229/FO-230
155 mm

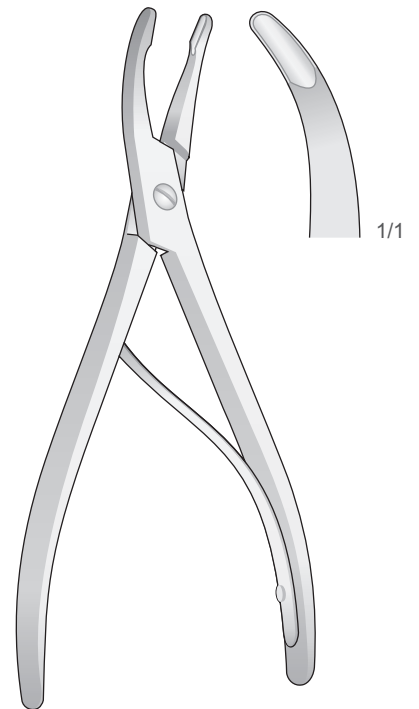

LUER
FO-18
155 mm

PERIOSTEALS,
CURETTES & BONE

Hohlmeißelzangen
 Bone rongeurs
 Pinze ossivore
 Pinzas gubias
 Pincas gouges

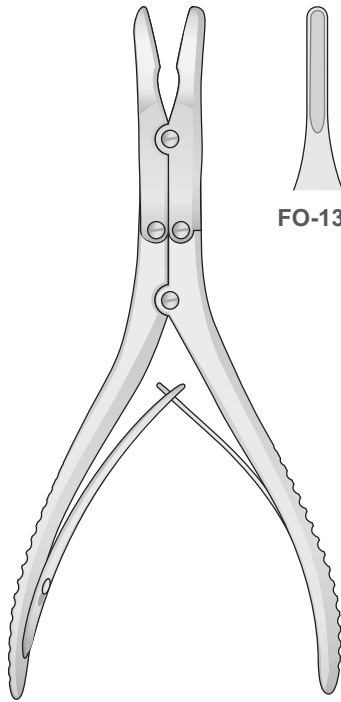

FO-138 1/1

FO-139 1/1

RUSKIN
 FO-138/FO-139
 150 mm

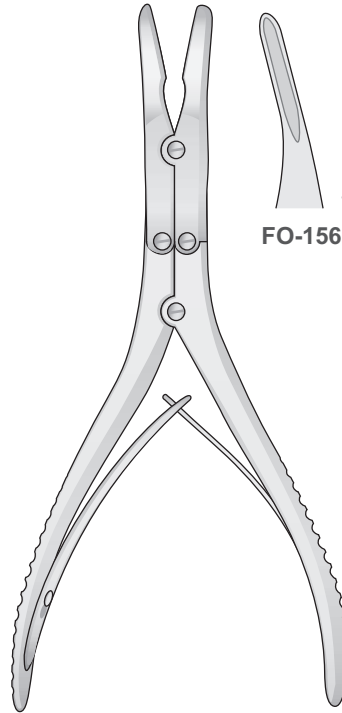

FO-156 1/1

FO-157 1/1

KLEINERT-KUTZ
 FO-156/FO-157
 155 mm

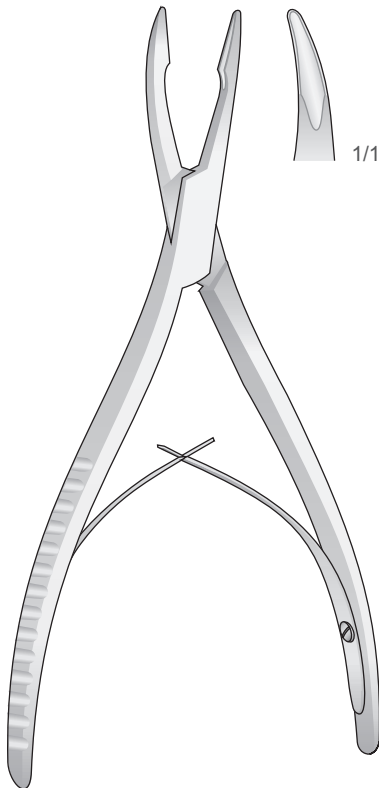

1/1

FRIEDMANN
 FO-16
 160 mm

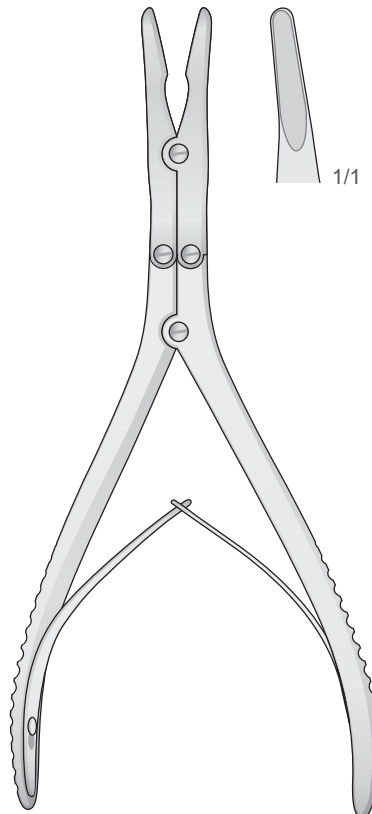

1/1

BEYER
 FO-20
 180 mm

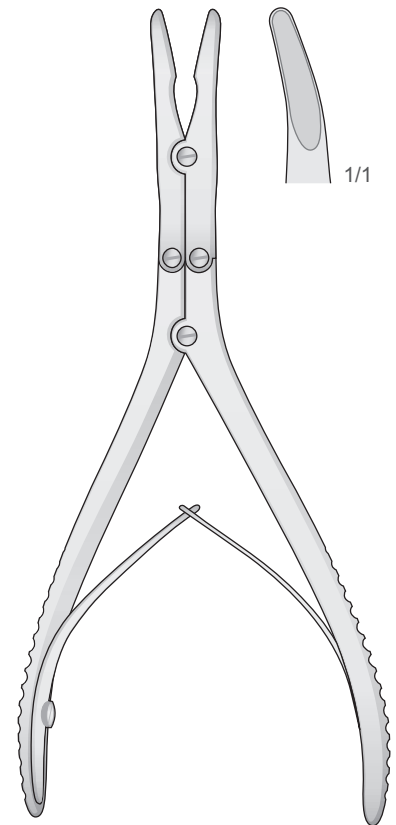

1/1

ZAUFAL-JANSEN
 FO-34
 180 mm

PERIOSTEALS,
 CURETTES & BONE

Hohlmeißelzangen
 Bone rongeurs
 Pinze ossivore
 Pinzas gubias
 Pincas gouges

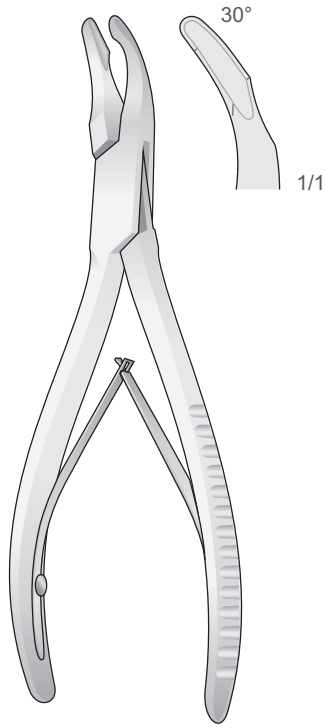

CLEVELAND
FO-231 140 mm
FO-232 170 mm

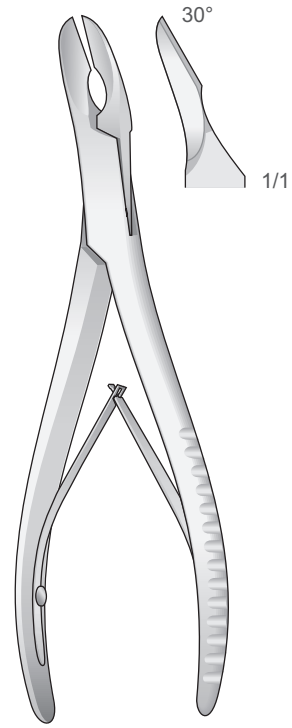

CLEVELAND
FO-233 150 mm
FO-234 170 mm

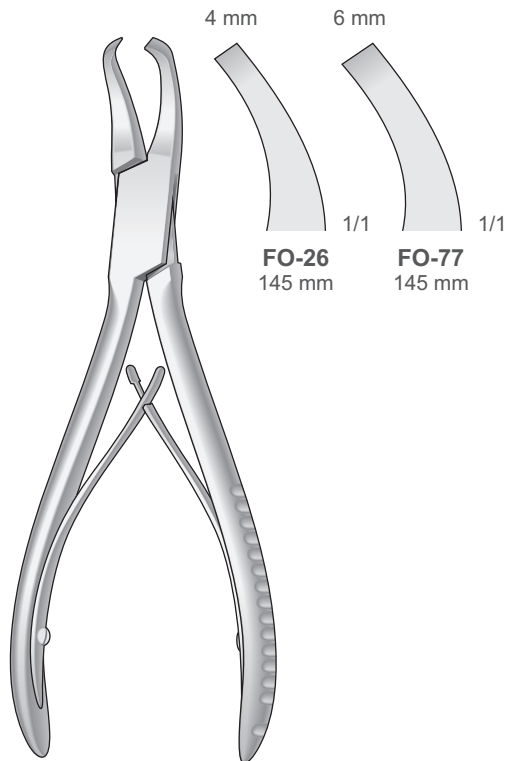

GARDNER
FO-26/FO-77
 145 mm

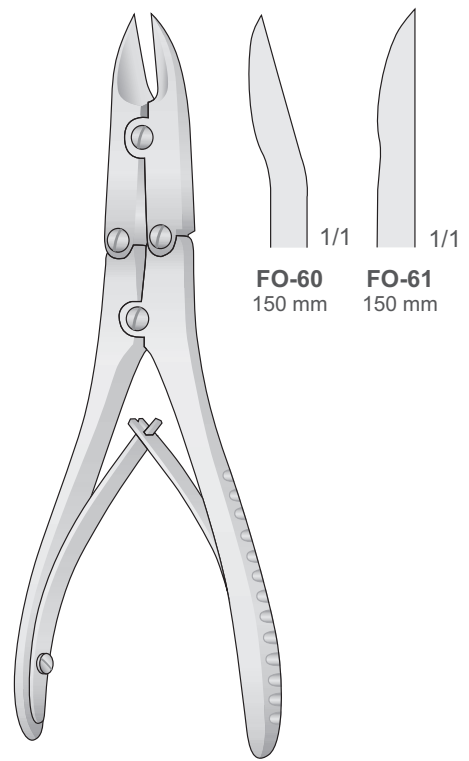

BÖHLER
FO-60/FO-61
 150 mm

PERIOSTEALS,
 CURETTES & BONE

Bone Cutting Forceps

Knochensplitterzangen
 Bone cutting forceps
 Pinze ossivore
 Pinzas cortantes para huesos
 Pinces coupantes à os

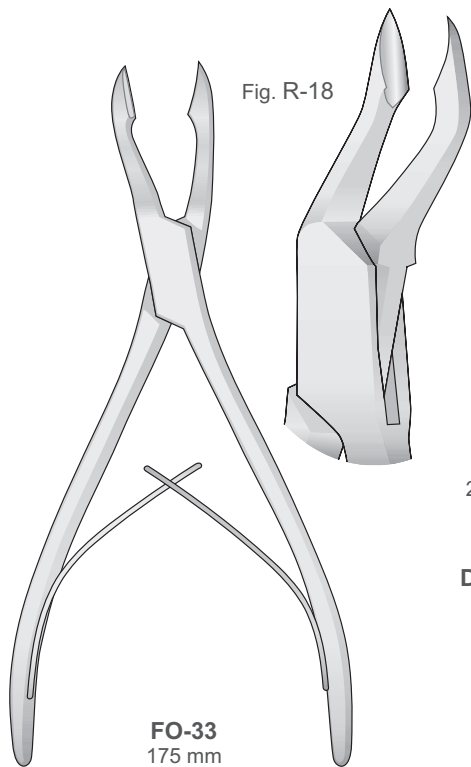
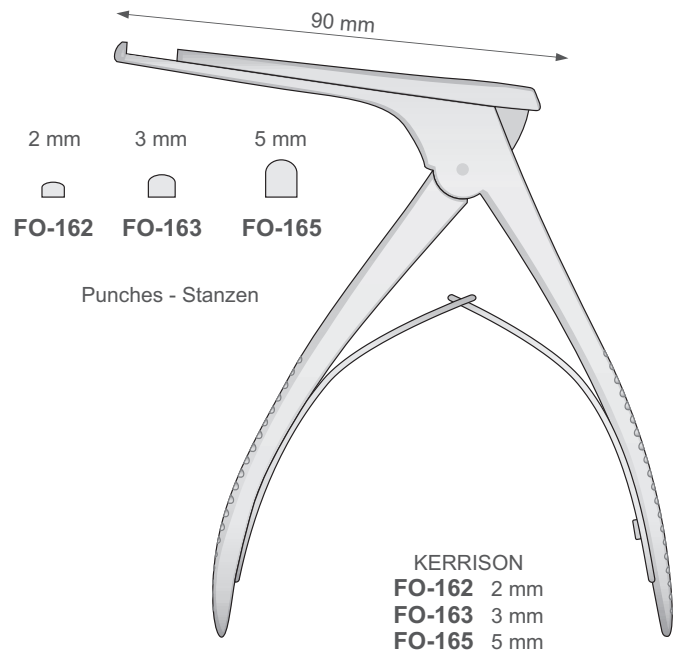

PERIOSTEALS,
 CURETTES & BONE

Bone cutting forceps
 for opening the Sinus
 Strumento tagliente per
 aumentare il volume del seno

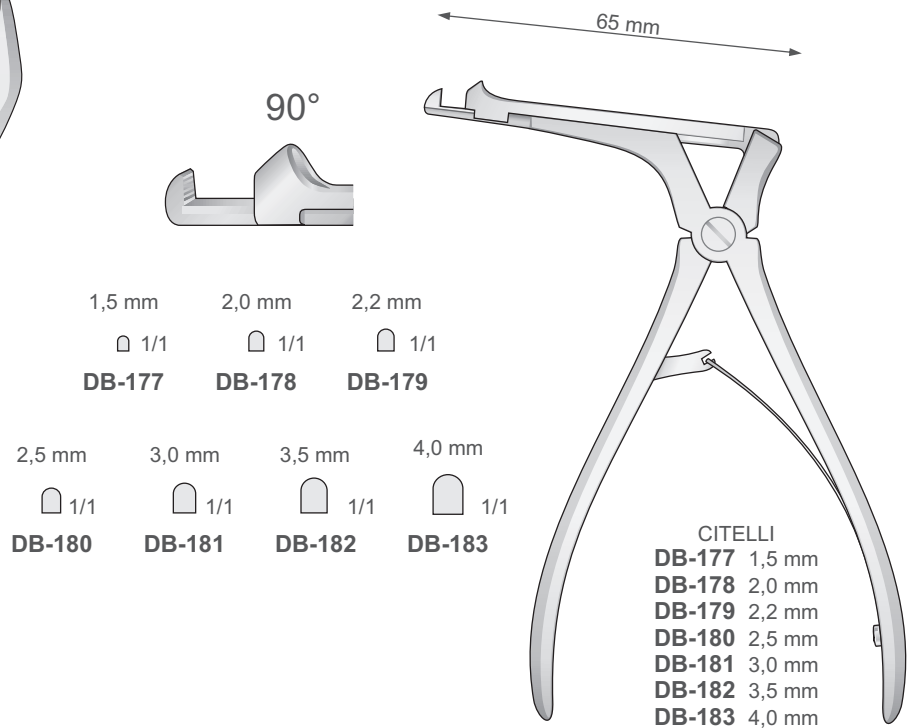

• Periodontics / Endodontics / Restoration

249 | Periodontics

254 | Endodontics

257 | Diagnostic

261 | Curettes and Scalers

269 | Amalgam

271 | Composite

274 | Spatulas

275 | Filling

281 | Dental Restoration

285 | Perio Chisels and Knives

**288 | Perio Probes and
Explorers**

291 | Filling

302 | Curettes and Scalers

308 | Rubber-Dam



Zahnsonden
Explorers - Sickle Probes
Esploratori - Sonde falce
Sondas exploradoras
Sondes exploratrices

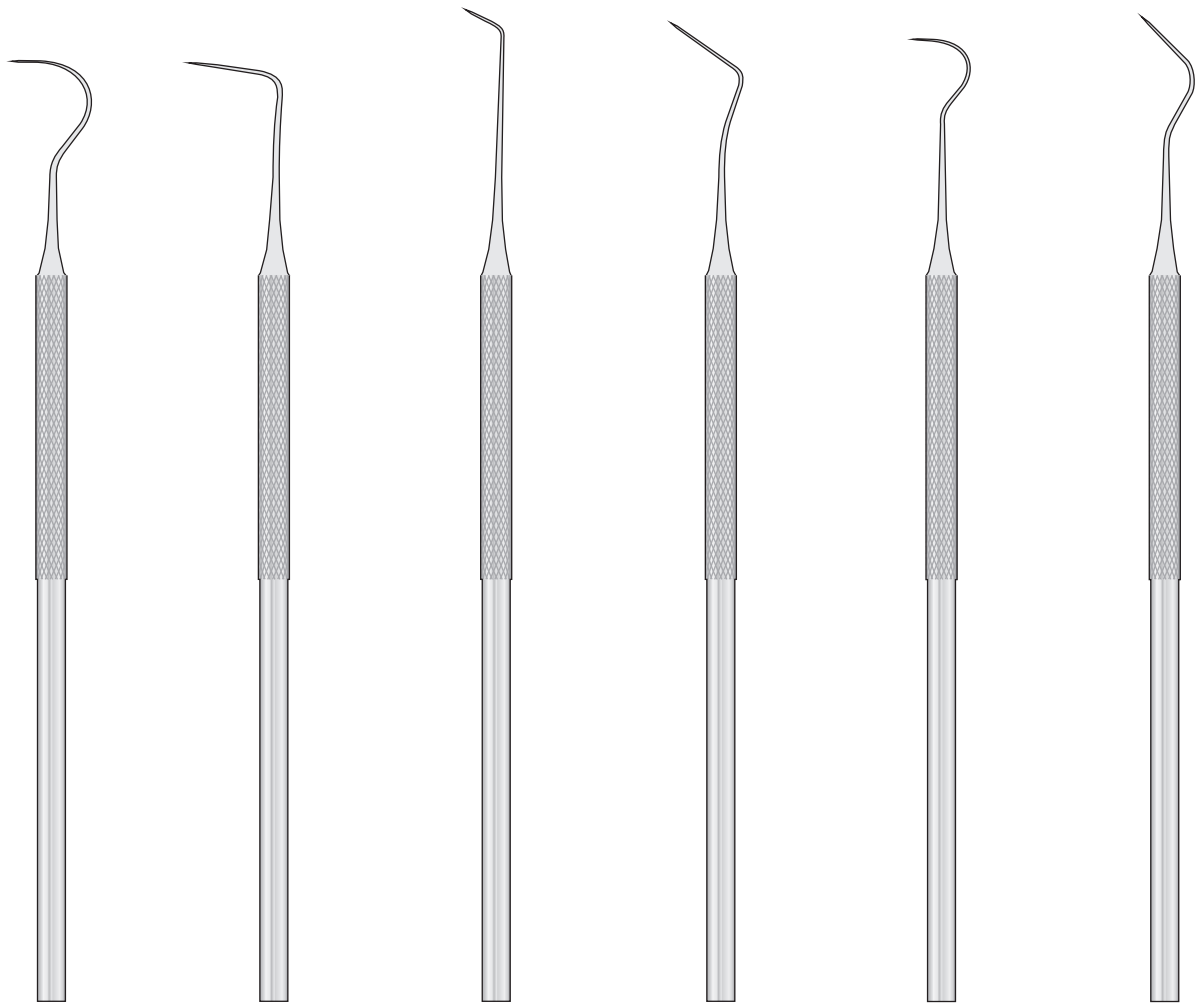

SO-1
Fig. 23

SO-2
Fig. 11

SO-3
Fig. 6

SO-4
Fig. 9

SO-5
Fig. 2

SO-6
Fig. 10

PERIO. ENDO
& RESTORATION

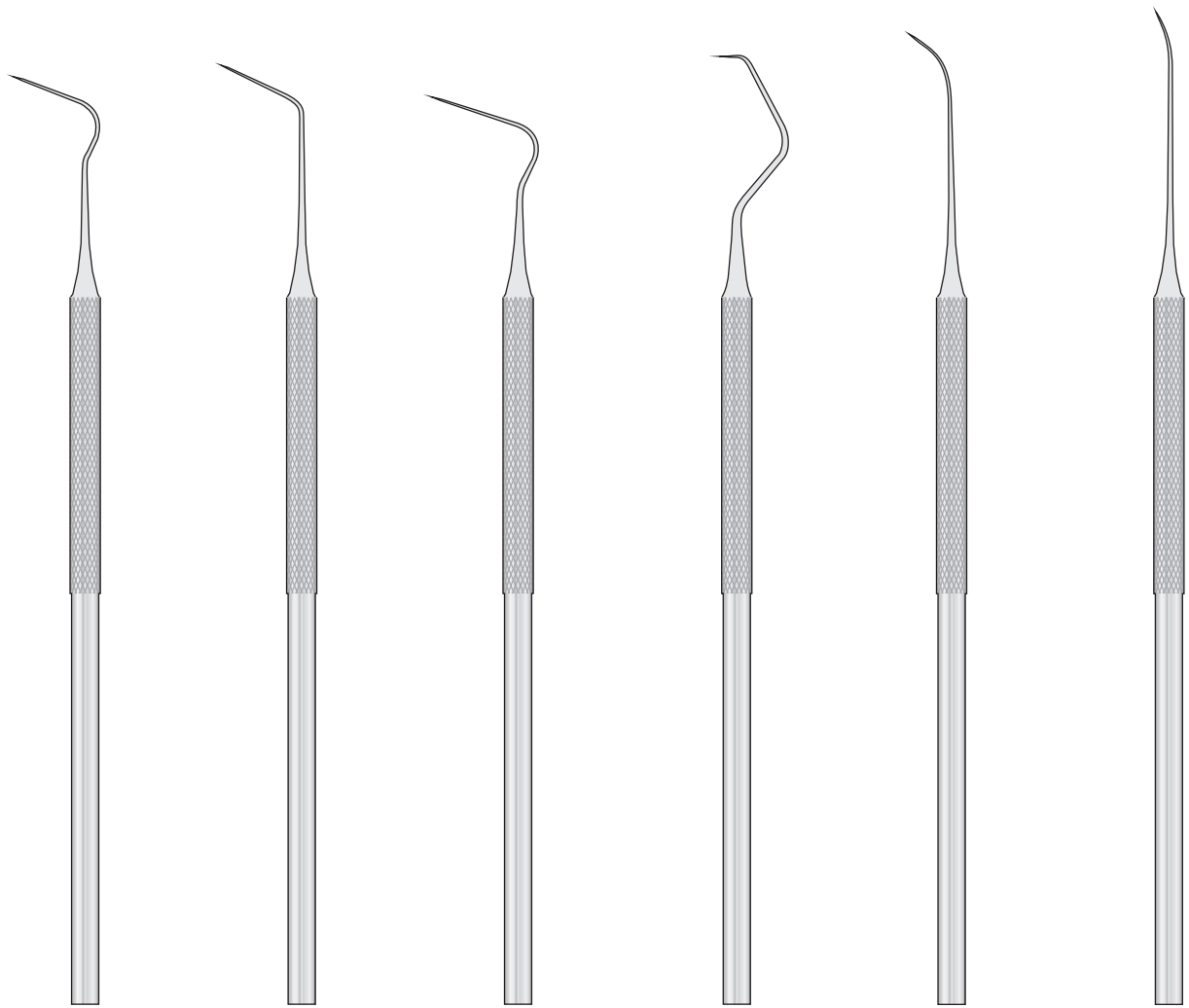

SO-7
Fig. 12

SO-8
Fig. 6A

SO-9
Fig. 8A

SO-10
Fig. 17A

SO-11
Fig. 3A

SO-12
Fig. 3

Parodontometer
 Periodontal Probes
 Sonde parodontali
 Sondas parodontales
 Sondes parodontales

Do not use Ultrasonic Cleaning
 Verwenden Sie keine Ultraschall-Reinigung
 Ne pas utiliser nettoyage à ultrasons
 No usar limpieza ultrasónica
 Non usare lavatrici ad ultrasuoni



Do not use metal brushes
 Keine Drahtbürste verwenden
 Ne pas utiliser de brosses métalliques
 No utilizar cepillos metálicos
 Non utilizzare spazzole metalliche

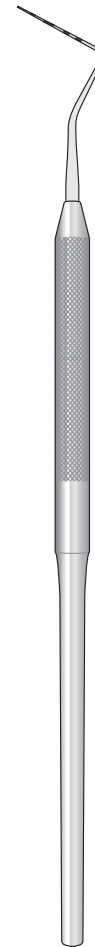
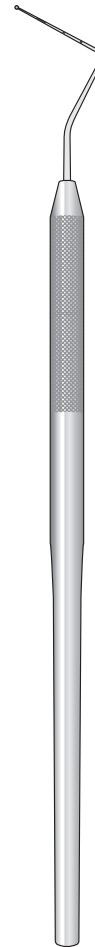
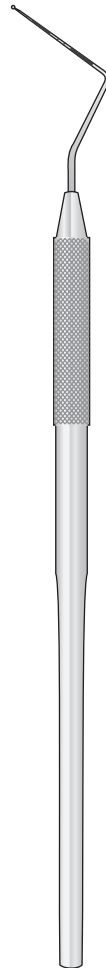
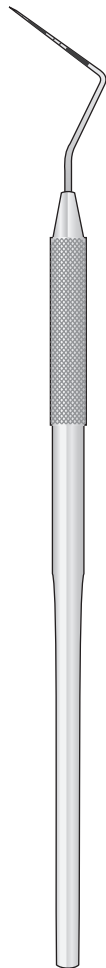
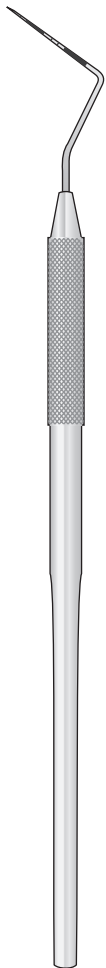
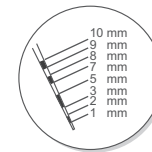
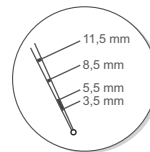
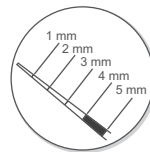
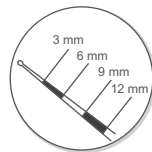
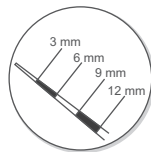

CP-11
SM-11
 160 mm

CP-12
SM-12
 160 mm

CP-12S
SM-13
 160 mm

CP-15UNC
SM-15
 160 mm

WHO
SM-21
 160 mm

CP-10
SM-19
 160 mm

PERIO. ENDO
 & RESTORATION

Double-ended Explorer
 Doppelendiger Zahnsonden
 Sonde esploratrice double
 Sonda exploradora doble
 Sonda falce doppia



11/12 ODU
SO-20
 165 mm

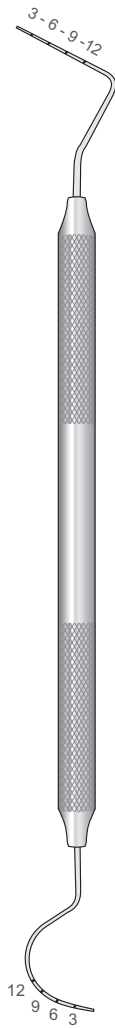

CATTONI
 UT3/4
SM-20
 165 mm



NABERS
 2QN
SM-22
 175 mm



WILLIAMS
 23 CP-11
EX-11
 165 mm

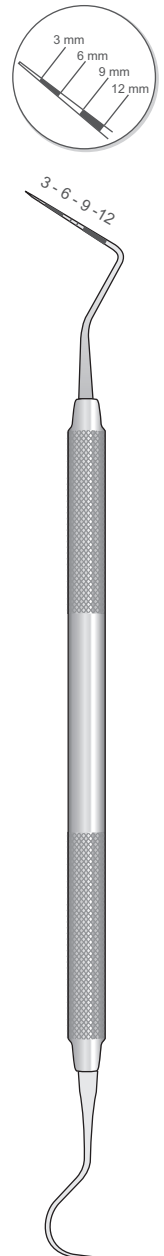

WILLIAMS
 23 CP-12
EX-12
 165 mm

Parodontometer
Periodontal Probes
Sonde parodontali
Sondas parodontales
Sondes parodontales

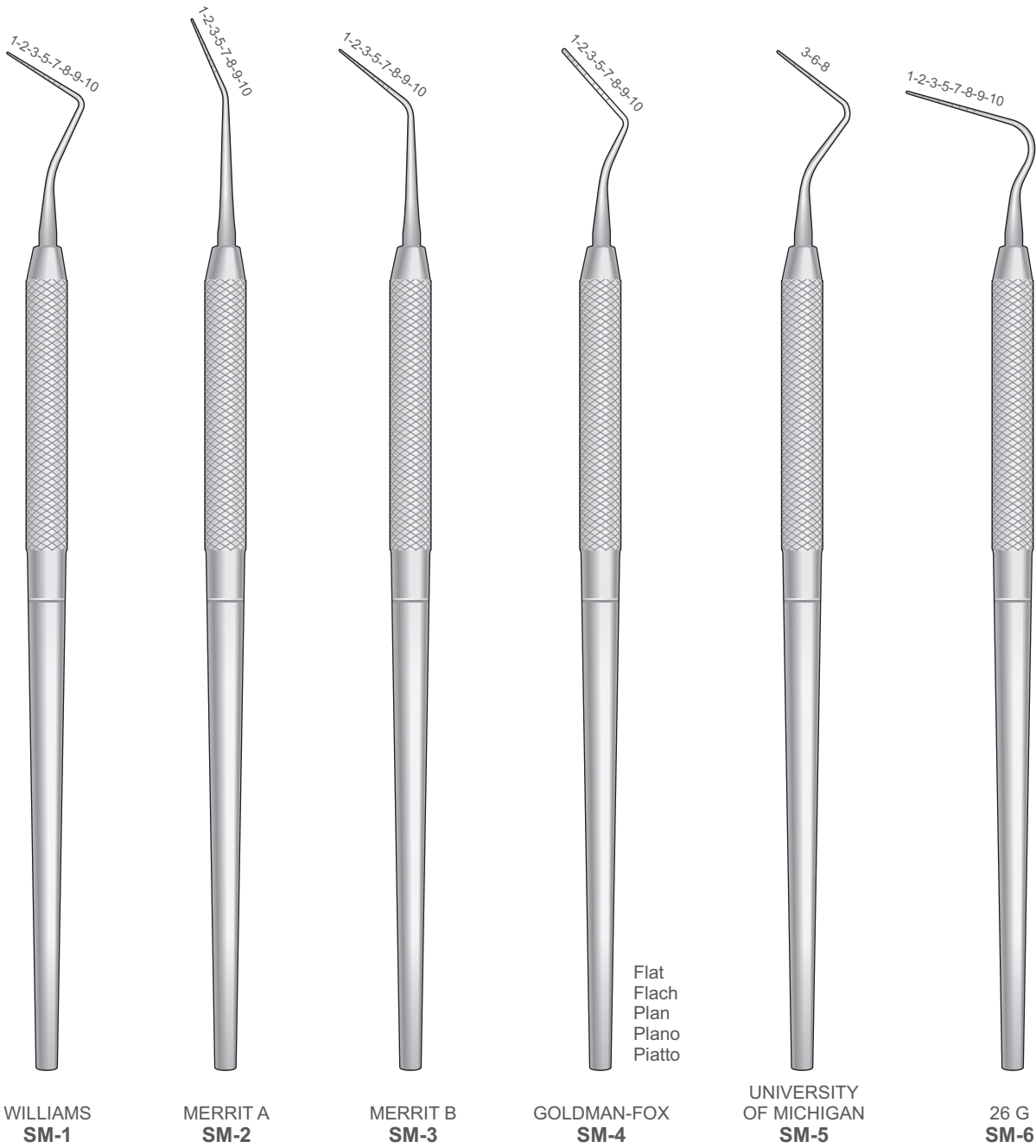

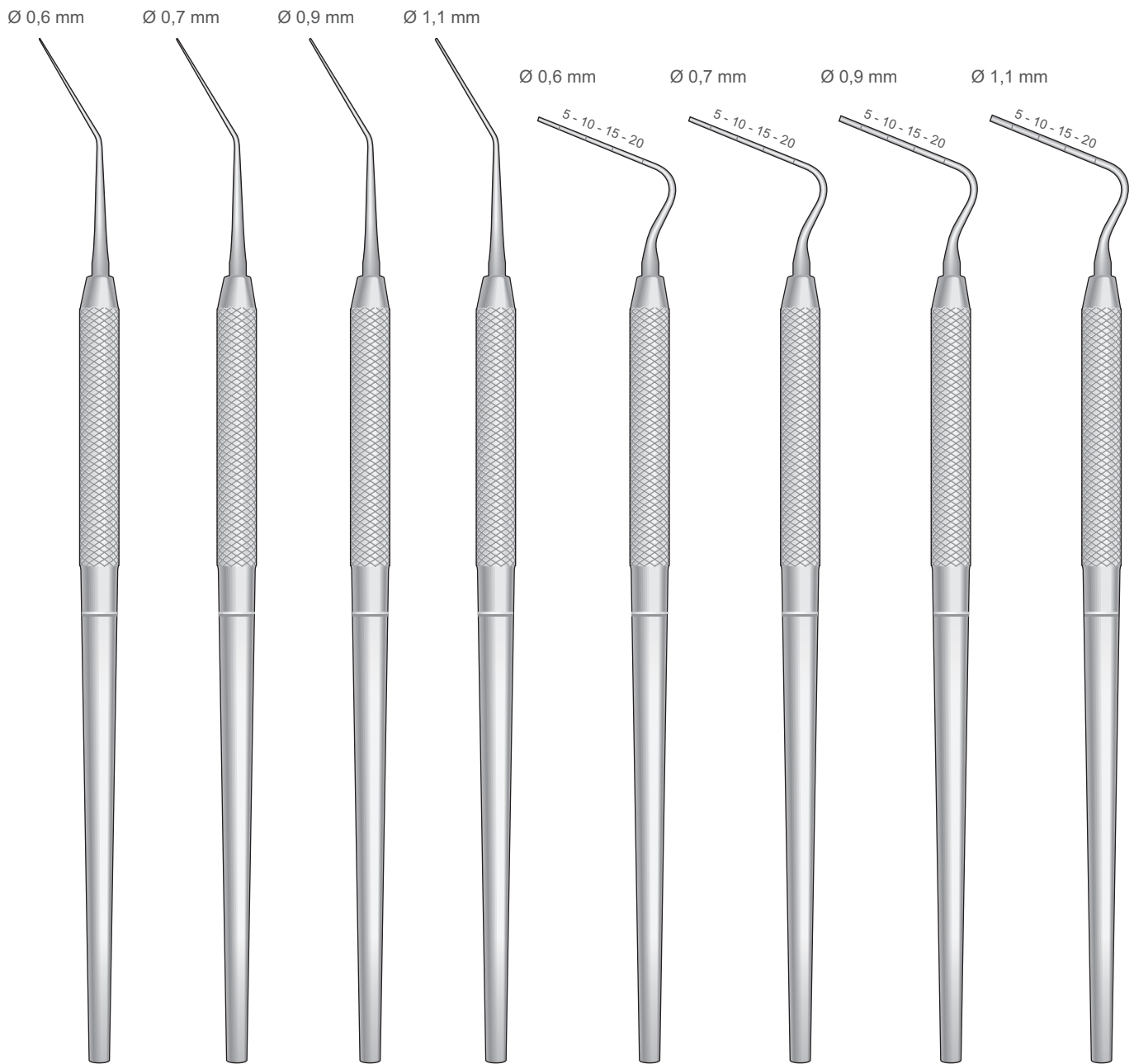

LUKS
PL-1
Fig.1

LUKS
PL-2
Fig.2

LUKS
PL-3
Fig.3

LUKS
PL-4
Fig.4

PZ-1
Fig.1

PZ-2
Fig.2

PZ-3
Fig.3

PZ-4
Fig.4

Spreaders

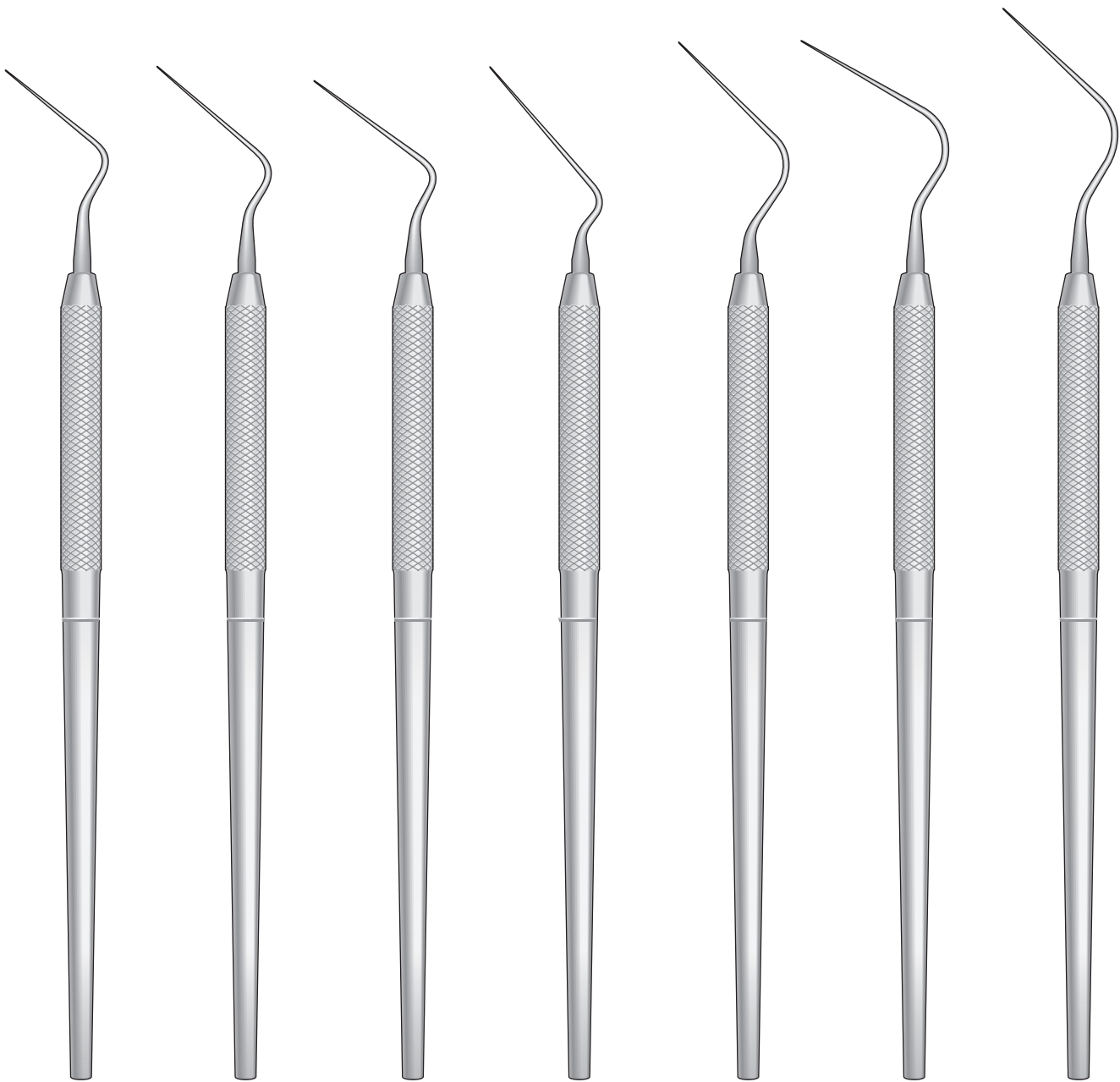

SP-1
Fig.1S

SP-2
Fig.2S

SP-3
Fig.D11

SP-4
Fig.MA57

SP-5
Fig.0

SP-6
Fig.00

SP-7
Fig.3

Tamponstopfer
Gauze Packers
Porta tamponi
Portatampones
Porte tampons

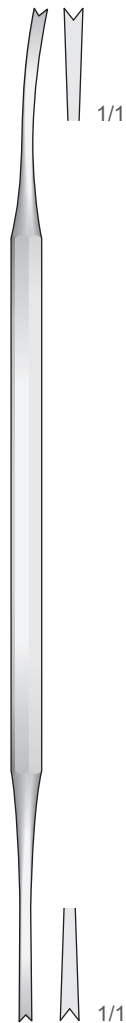

LUNIATSCHEK
PF-6
170 mm



UNIVERSAL
PF-40
140 mm

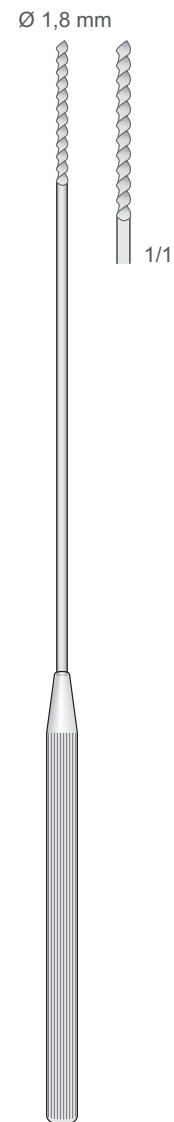

UNIVERSAL
PF-41
180 mm

DOUBLE SIDED FRONT SURFACE RHODIUM MIRROR
Stainless steel - Rhodium coating

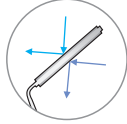

Reflecting surface is on **FRONT** of the glass.
Clear image. No distortion. No double/ghost image.
Rhodium coating for scratch resistance.
Enhanced indirect vision & illumination of dark areas.
Ergonomic & stream-lined design for less bulk.
+Visibility in any position: **2 opposite reflective faces**
(no need to turn the mirror to change from right to left).
Smoothly finished & retractor shaft design for patient comfort.

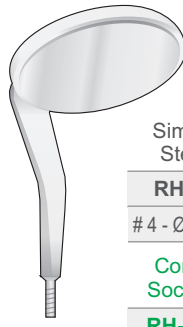

Box of 6

Simple Stem

RH-14

4 - Ø 22mm

Cone Socket

RH-15A

5 - Ø 24mm

FRONT SURFACE RHODIUM MIRRORS
Stainless steel - Rhodium coating

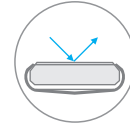

Reflecting surface is on **FRONT** of the glass.
Clear image. No distortion. No double/ghost image.
Rhodium coating for scratch resistance.
Enhanced indirect vision & illumination of dark areas.
Used for retraction of lips, cheeks and tongue.

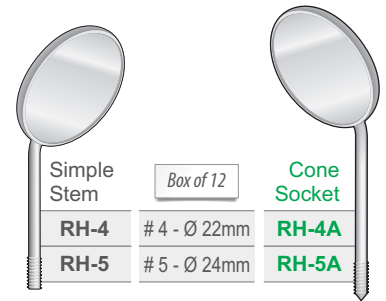

Simple Stem

Box of 12

RH-4

4 - Ø 22mm

RH-5

5 - Ø 24mm

Cone Socket

RH-4A

RH-5A

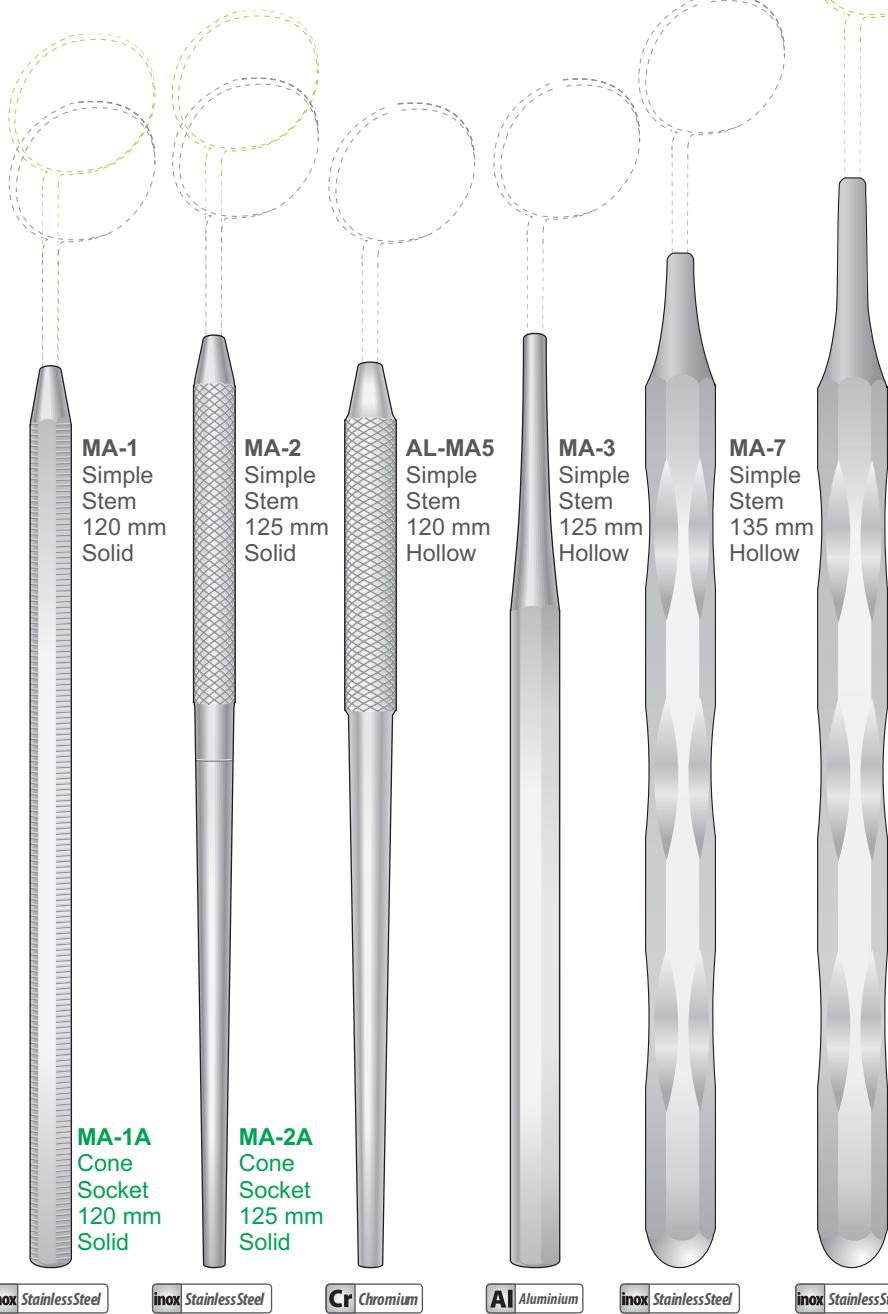

MA-1
Simple Stem
120 mm
Solid

MA-2
Simple Stem
125 mm
Solid

AL-MA5
Simple Stem
120 mm
Hollow

MA-3
Simple Stem
125 mm
Hollow

MA-7
Simple Stem
135 mm
Hollow

MA-1A
Cone Socket
120 mm
Solid

MA-2A
Cone Socket
125 mm
Solid

MA-7A
Cone Socket
120 mm
Hollow

inox StainlessSteel

inox StainlessSteel

Cr Chromium

Al Aluminium

inox StainlessSteel

inox StainlessSteel

PLANE MIRRORS

Stainless steel - Aluminium coating

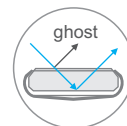

Re ecting surface is on **REAR** of the glass.
Aluminium coating. Good image quality.
Flat mirror produce double/ghost image.
Low-cost.



Simple Stem

Box of 12

P-3

3 - Ø 18mm

P-4

4 - Ø 22mm

P-5

5 - Ø 24mm

Concave with enlarging effect



Simple Stem

Box of 12

G-3

3 - Ø 18mm

G-4

4 - Ø 22mm

G-5

5 - Ø 24mm

Spiegeldurchmesser - Diameter of mirrors
 Diametro dello specchio - Diamètre des miroirs
 Diámetro de los espejos

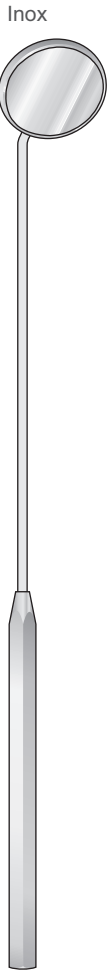
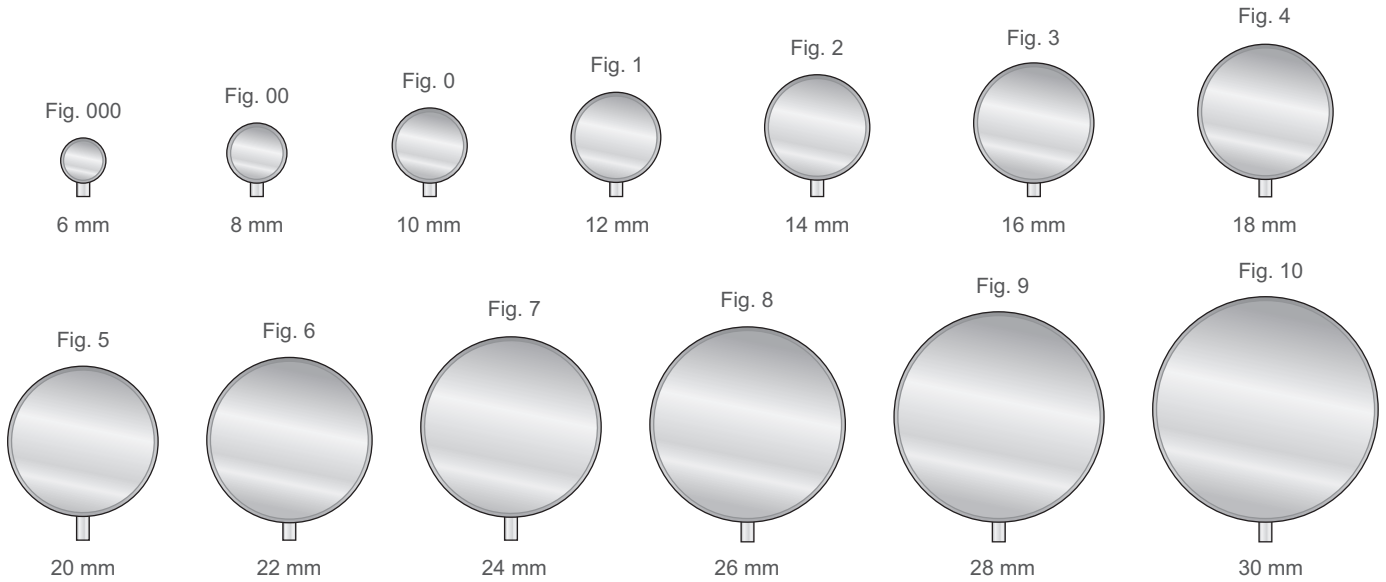

Kehlkopfspiegel mit
 Sechskantgriff
 Laryngeal mirrors
 with hexagonal handle
 Specchietto laringeo
 con manico esagonale
 Espejo laringeo
 con mango hexagonal
 Miroirs laryngiens
 avec manche hexagonal

- G-8 Fig. 00
- G-10 Fig. 0
- G-12 Fig. 1
- G-14 Fig. 2
- G-16 Fig. 3
- G-18 Fig. 4
- G-20 Fig. 5
- G-22 Fig. 6
- G-24 Fig. 7
- G-26 Fig. 8
- G-28 Fig. 9
- G-30 Fig. 10

G-8/G-30
180 mm

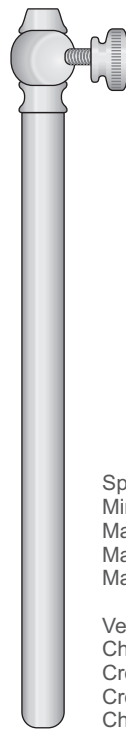

Spiegelgriff
 Mirrors handle
 Manico per specchietti
 Mango para espejos
 Manche à miroir

Verchromt
 Chromium
 Cromato
 Cromado
 Chromé

MA-6
120 mm

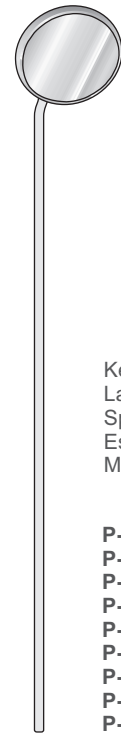

Kehlkopfspiegel
 Laryngeal mirrors
 Specchietto laringeo
 Espejos laringeos
 Miroirs laryngiens

- P-000 Fig. 000
- P-00 Fig. 00
- P-0 Fig. 0
- P-01 Fig. 1
- P-02 Fig. 2
- P-03 Fig. 3
- P-04 Fig. 4
- P-05 Fig. 5
- P-06 Fig. 6

P-000/P-06
120 mm

Dental-Spritzen
Dental Syringes
Siringhe dentali
Jeringas dentales
Seringues dentaires

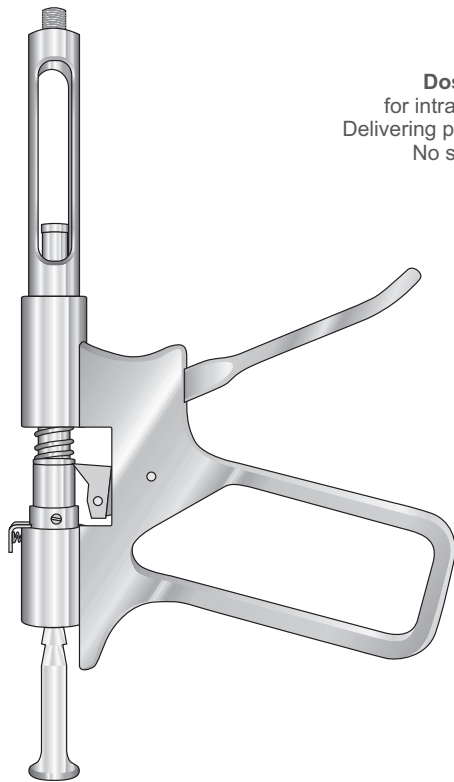

Dosing Lever Syringe
for intraligamentary anesthesia.
Delivering precisely 0.2 ml of anesthetic.
No soft-tissue numbness.

SD-7
Imperial Tip
1.8 ml

SD-7M
Metric Thread
1.8 ml

SD-9NA
Imperial Tip
1.8 ml
(Sold only in
North America)



SD-7R
Autoclavable plastic
protection sleeve
for SD-7

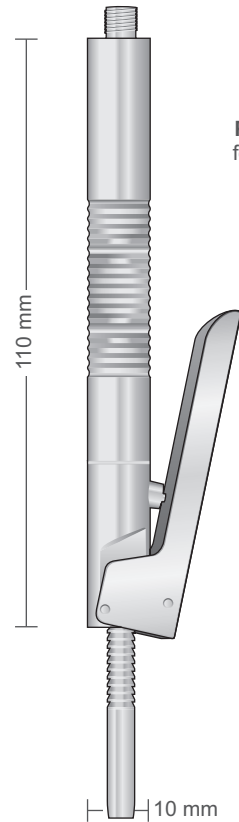

Pen-style Syringe
for intraligamentary
anesthesia

SD-20
Imperial Tip
1.8 ml

SD-20M
Metric Thread
1.8 ml

**Aspirating
Anesthetic Syringe**

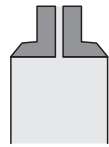

Aspirating
syringes feature a
blunt harpoon rod.

Lightweight and
Ergonomic.

High quality
stainless steel.

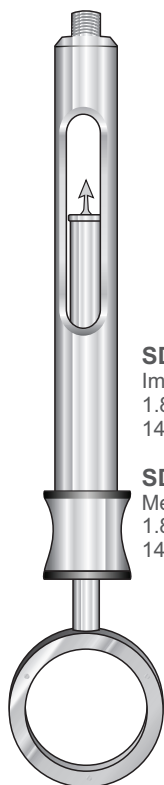

SD-8
Imperial Tip
1.8 ml
140mm

SD-8M
Metric Thread
1.8 ml
140mm

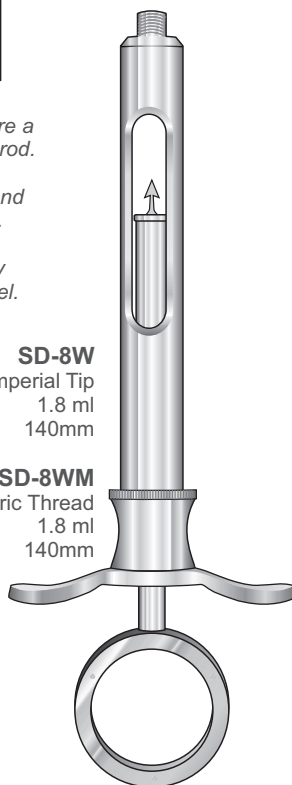

SD-8W
Imperial Tip
1.8 ml
140mm

SD-8WM
Metric Thread
1.8 ml
140mm

**Aspirating and
Self Aspirating
Anesthetic Syringe**

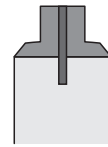

Self-aspirating
mechanism allows to
aspirate by means of
counter pressure.

Lightweight and
Ergonomic.

High quality
stainless steel.

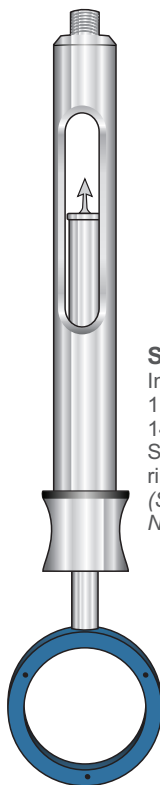

SD-8NA
Imperial Tip
1.8 ml
140mm
Silicone covered
ring handle
(Sold only in
North America)

Silicone
covered
ring handle

**Self Aspirating
Anesthetic Syringe**



SD-88
Imperial Tip
1.8 ml
140mm

SD-88M
Metric Thread
1.8 ml
140mm

PERIO. ENDO
& RESTORATION

Zylinder-Ampullen Spritzen
 Cartridge Syringes
 Siringhe per tubofiale
 Jeringas de ampollas
 Seringues d'ampoules

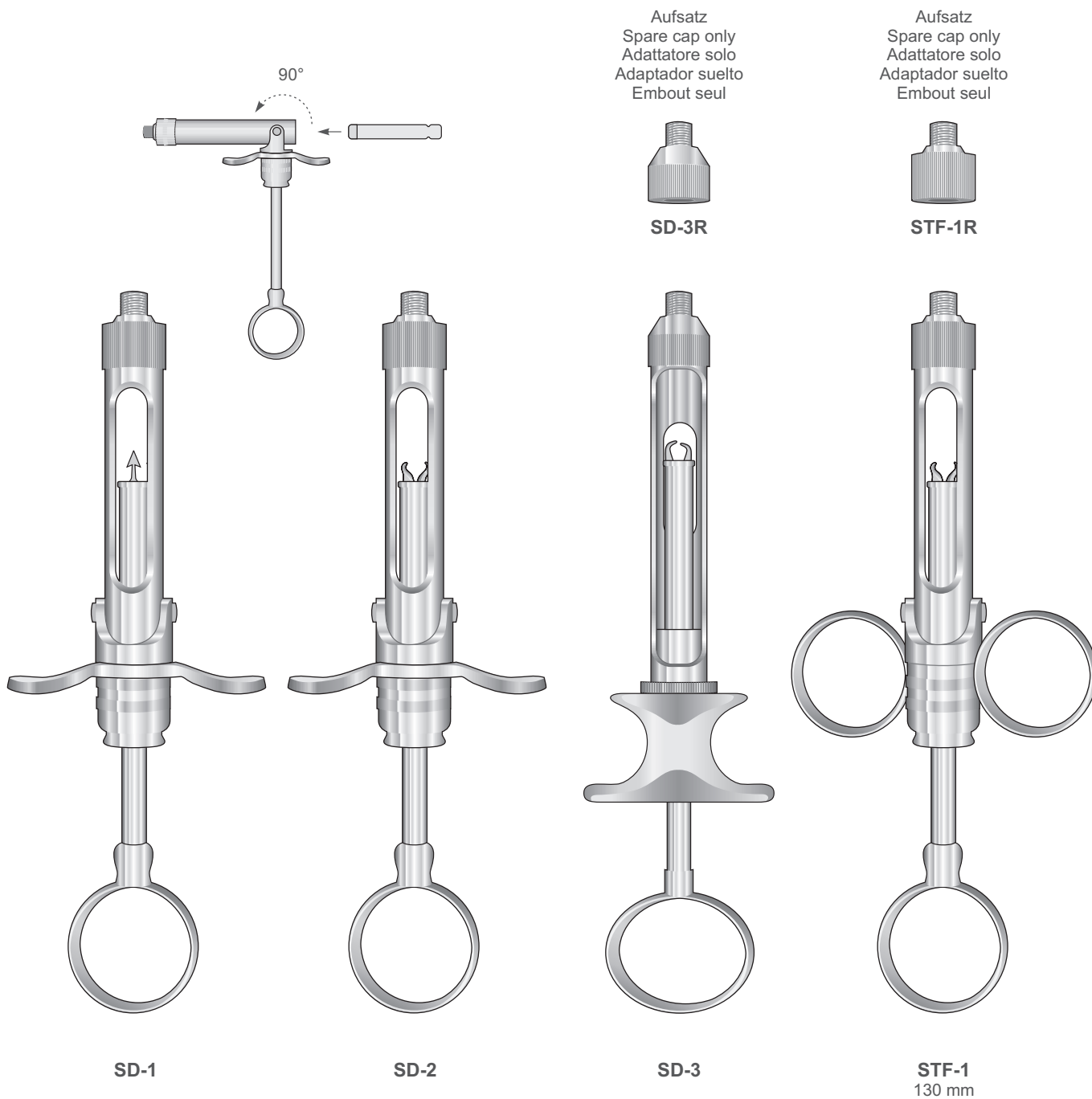



GRACEY
CU-1/2



GRACEY
CU-3/4



GRACEY
CU-5/6



GRACEY
CU-7/8



GRACEY
CU-9/10



GRACEY
CU-11/12



GRACEY
CU-13/14

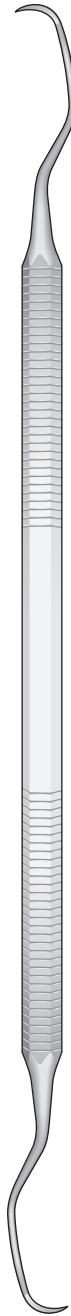

LANGER Fig. 1/2
COL-1/2



LANGER Fig. 3/4
COL-3/4



COLUMBIA
COL-2RL

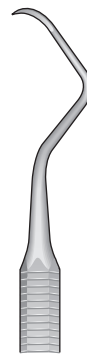

COLUMBIA
COL-4RL



COLUMBIA
COL-13/14

Elite
 Stainless Steel

Balanced and ergonomic for great tactile working ability. Maintains long sharp edges. Extra light hollow handle for optimum comfort (feather weight / round Ø 9 mm).

Ausgewogen und ergonomisch für eine gute Anwendbarkeit. Dauerhafte scharfe Ecken. Extra leichte Hohigriffe für optimale Komfort (Federleicht).

Équilibrés et ergonomiques pour une plus grande habileté tactile. Bords tranchants durables. Manche extra léger et creux pour un confort optimal (poids plume).

Equilibrado y ergonómico para mayor una facilidad de táctil. Bordes afilados durables. Mango hueco ultra-liviano para un confort óptimo (peso pluma).

Bilanciata ed ergonomiche per una maggiore facilità di lavoro. Bordi taglienti durevoli. Impugnatura cava, extra leggera, per un comfort ottimale (peso piuma).

Gracey Hygiene Chart

Anterior: 1/2, 3/4, 5/6
 Buccal Lingual Surfaces: 7/8, 9/10
 Mesial Surfaces Premolars, Molars: 11/12, 15/16
 Distal Surfaces Premolars, Molars: 13/14, 17/18

Also available: ET: Extra-Thin (micro), S: Small (mini 5) and L: Long (after 5)



USG-1/2ET
 Gracey
 Curette 1/2ET



USG-3/4ET
 Gracey
 Curette 3/4ET



USG-5/6ET
 Gracey
 Curette 5/6ET



USG-7/8ET
 Gracey
 Curette 7/8ET



USG-9/10ET
 Gracey
 Curette 9/10ET



USG-11/12ET
 Gracey
 Curette 11/12ET



USG-13/14ET
 Gracey
 Curette 13/14ET



USG-15/16ET
 Gracey
 Curette 15/16ET



USG-1/2
 Gracey
 Curette 1/2



USG-3/4
 Gracey
 Curette 3/4



USG-5/6
 Gracey
 Curette 5/6



USG-7/8
 Gracey
 Curette 7/8



USG-9/10
 Gracey
 Curette 9/10



USG-11/12
 Gracey
 Curette 11/12



USG-13/14
 Gracey
 Curette 13/14



USG-1/2S
 Gracey
 Curette 1/2S



USG-3/4S
 Gracey
 Curette 3/4S



USG-5/6S
 Gracey
 Curette 5/6S



USG-7/8S
 Gracey
 Curette 7/8S



USG-9/10S
 Gracey
 Curette 9/10S



USG-11/12S
 Gracey
 Curette 11/12S



USG-13/14S
 Gracey
 Curette 13/14S



PERIO. ENDO
 & RESTORATION

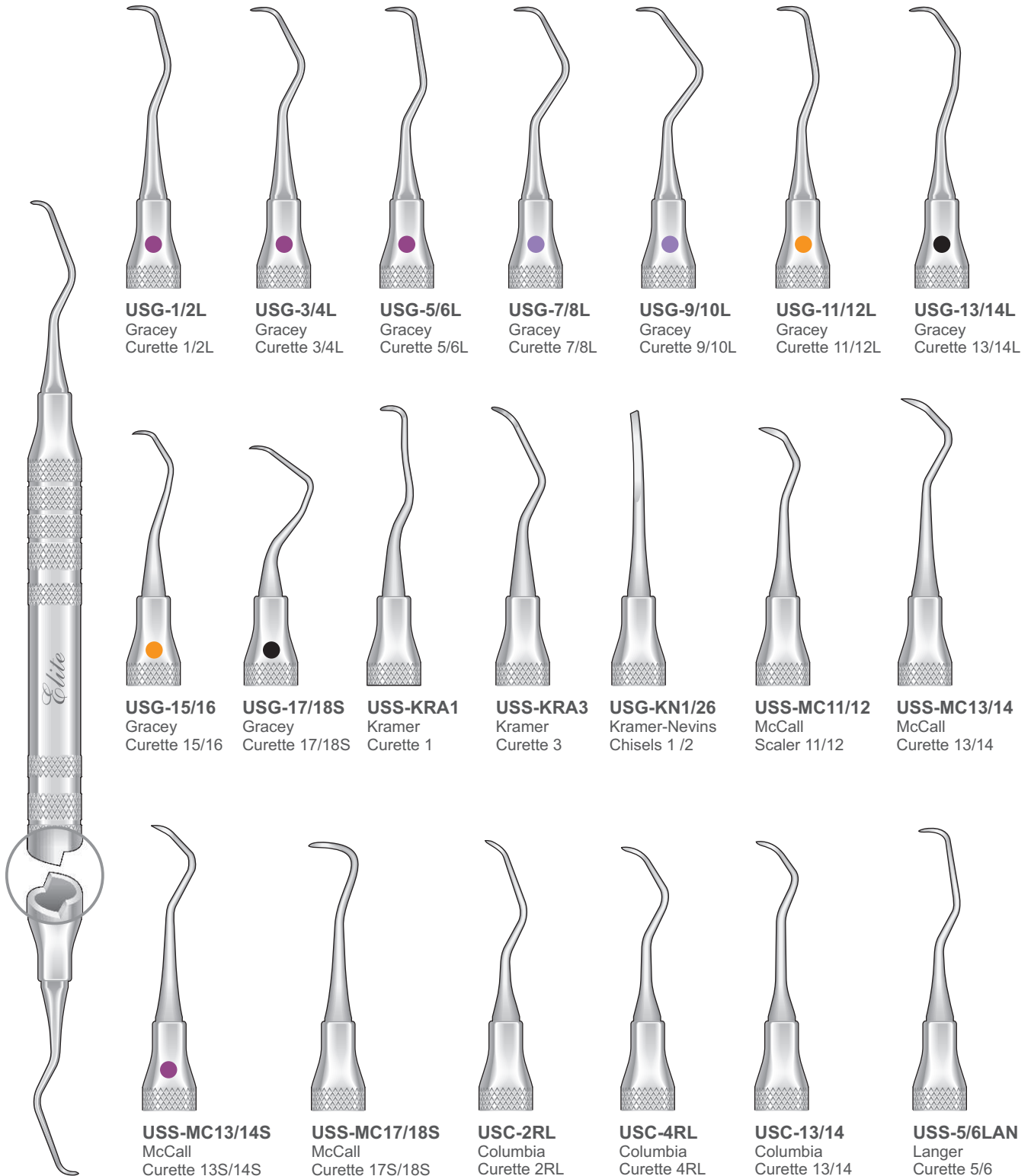

PERIO, ENDO
& RESTORATION



USS-NV0
 Nevi
 Scaler
 Nv0



USS-NV11/12
 Nevi
 Scaler
 NV11/12



USS-NV13/14
 Nevi
 Scaler
 NV13/14

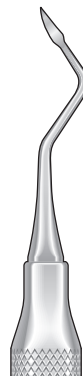

USS-T2/3
 Taylor
 Scaler 2/3



USS-204S
 Scaler
 204S



USS-H6/7
 Scaler
 H6/H7



USS-15/33
 Towner-Jaquette
 Scaler
 U15/J33



USS-5/33
 Jaquette
 Scaler
 H5/J33



USS-15/30
 Towner-Jaquette
 Scaler
 U15/J30



USS-J14/15
 Jaquette
 Scaler
 J14/15

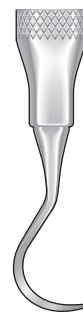
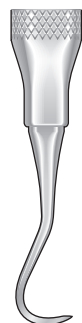

Elite TITANIUM

Long lasting solid titanium tip. Designed for removing calculus on implants surfaces. Gold coloured handle for easy identification purposes so they won't be mixed up with standard stainless instruments. (Leather weight / round Ø 9 mm).

Massivem Titan-Spitzen dass sie extrem widerstandsfähig und langlebig sind. Entwickelt für die Entfernung von Zahnbelag auf implantat Oberflächen. Vergoldete Griffe für eine einfache Kennzeichnung damit sie von Standard Instrumenten unterschieden werden können (Federleicht).

Puntas de titanio sólido más resistentes y durables. Diseñado para eliminar el sarro en los implantes de titanio. Mango dorado para una mejor identificación, el cual evita la confusión con los instrumentos de acero inoxidable estándar (peso pluma).

Punte in titanio sólido più resistente e durevole. Progettate per la rimozione di tartaro dalle superfici degli impianti. Manico color oro per un riconoscimento semplice e per evitare di essere confuse con i strumenti in acciaio (peso piuma).

Gracey Hygiene Chart

Anterior: 1/2, 3/4, 5/6 Buccal Lingual Surfaces: 7/8, 9/10 Mesial Surfaces Premolars, Molars: 11/12, 15/16 Distal Surfaces Premolars, Molars: 13/14, 17/18

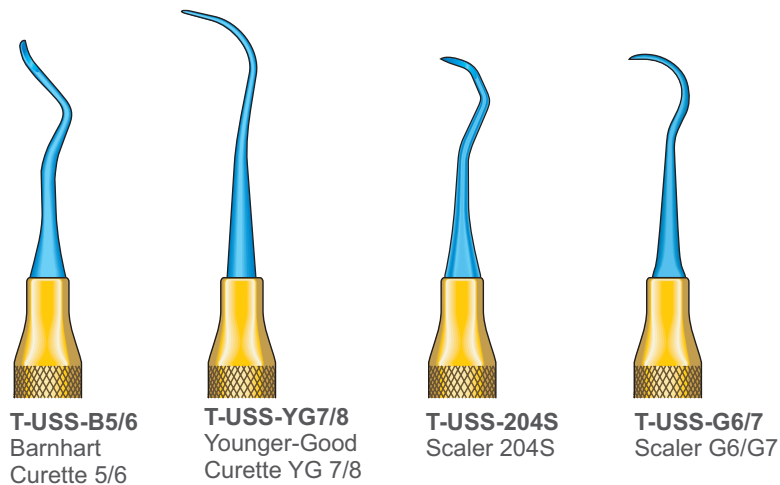
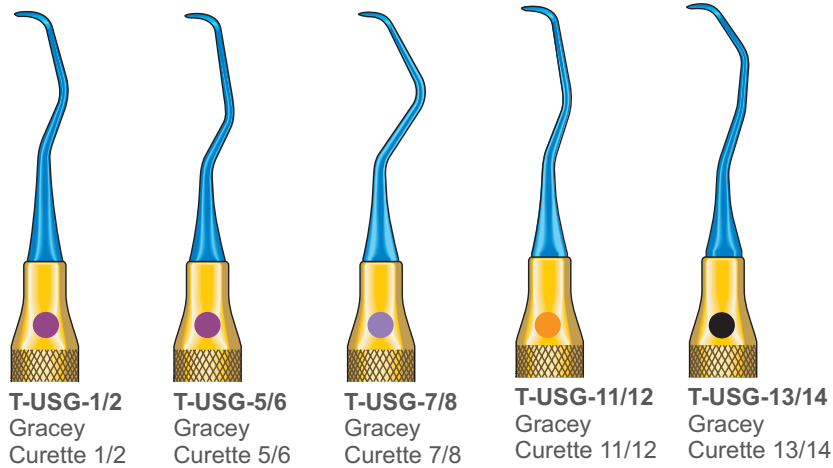

⚠ Use a dedicated sharpening stone for Titanium Scalers & Curettes.

Curettes - Files
 Curette - Lime
 Curetasc - Lima
 Curettes - Limes

Universal Küretten
 Universal Curettes
 Curette universali
 Curetas universales
 Curettes universelles

Parodontalfeilen
 Periodontal Files
 Lime parodontali
 Limas parodontales
 Limes parodontales

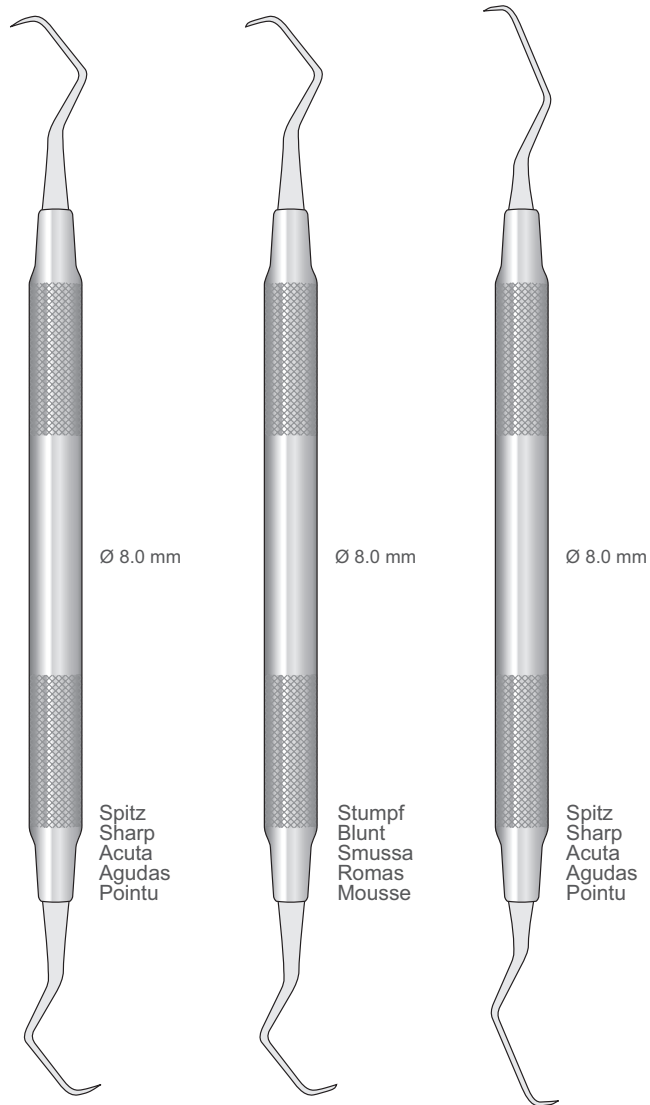

718-M23
165 mm

718-M23A
165 mm

718-M23B
170 mm

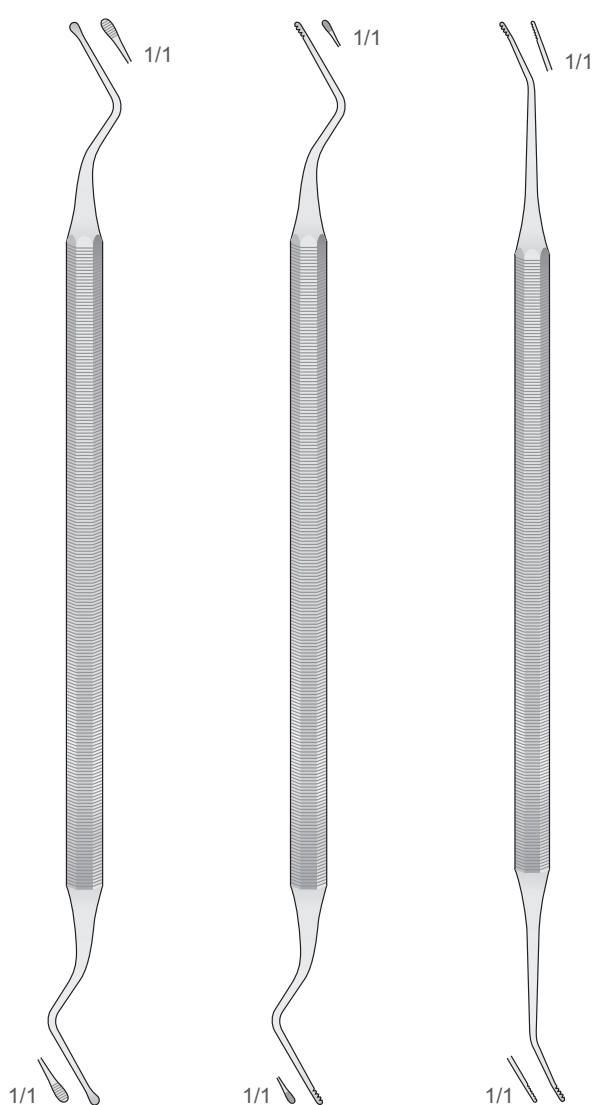

HIRSCHFELD
HF-3/7
170 mm

HIRSCHFELD
HF-5/11
170 mm

HIRSCHFELD
HF-9/10
175 mm

PERIO. ENDO
& RESTORATION

Scalers

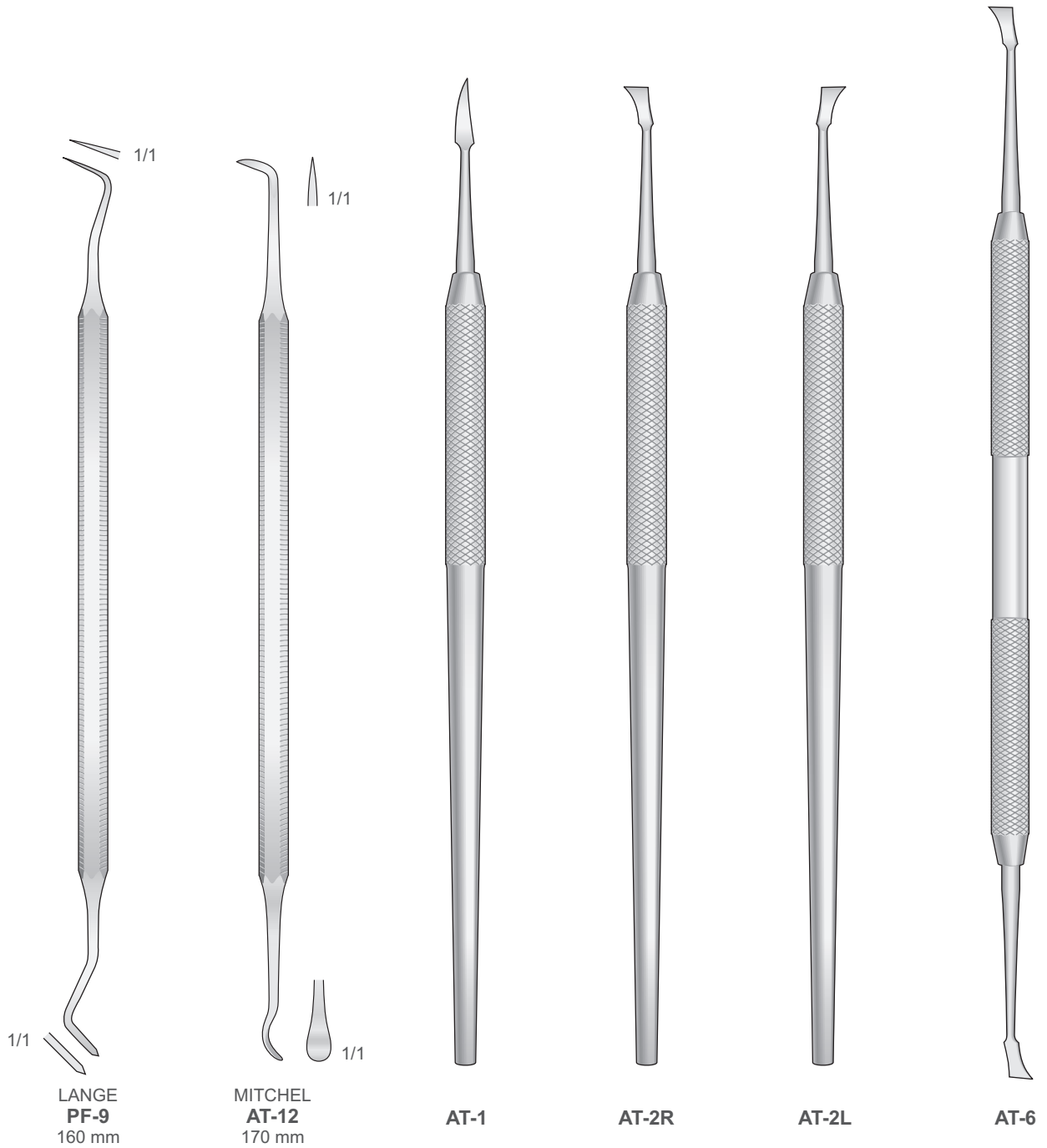

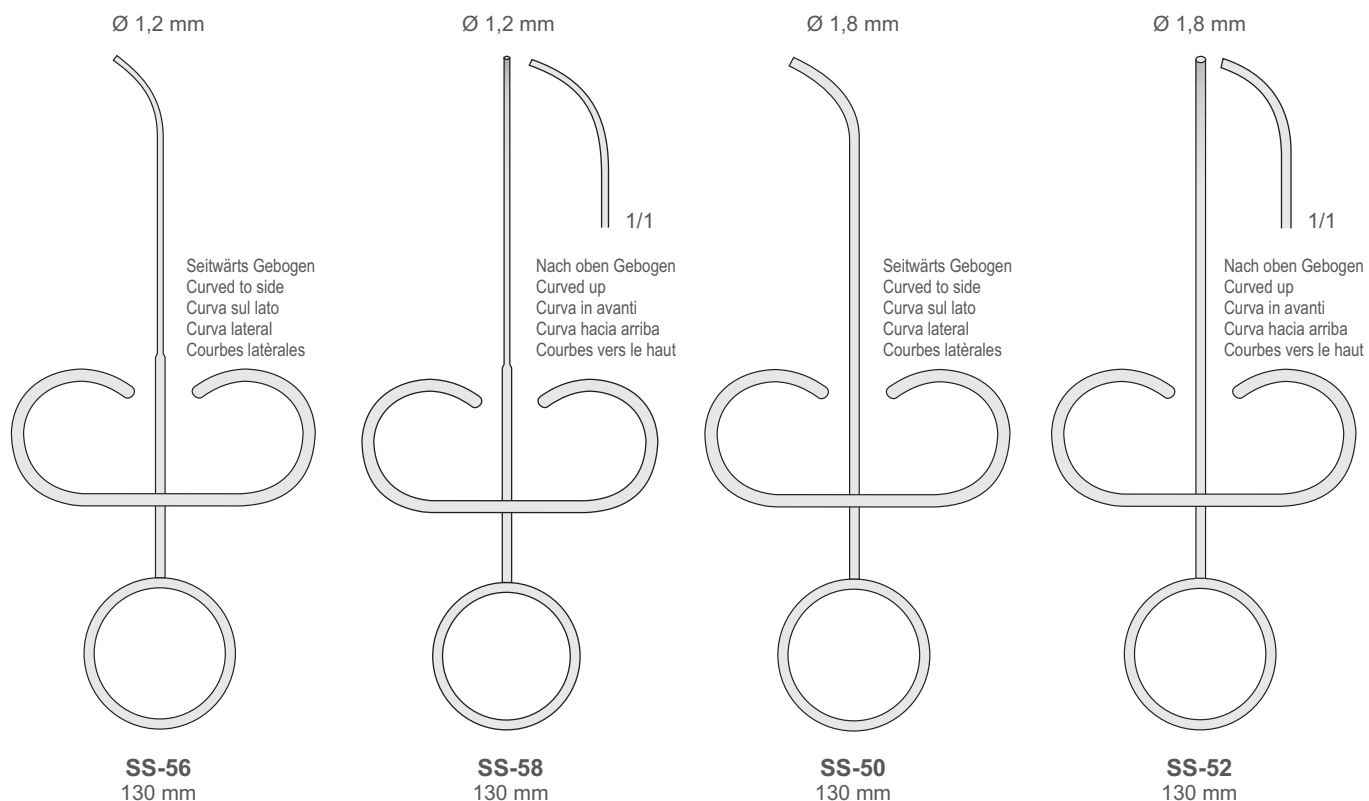
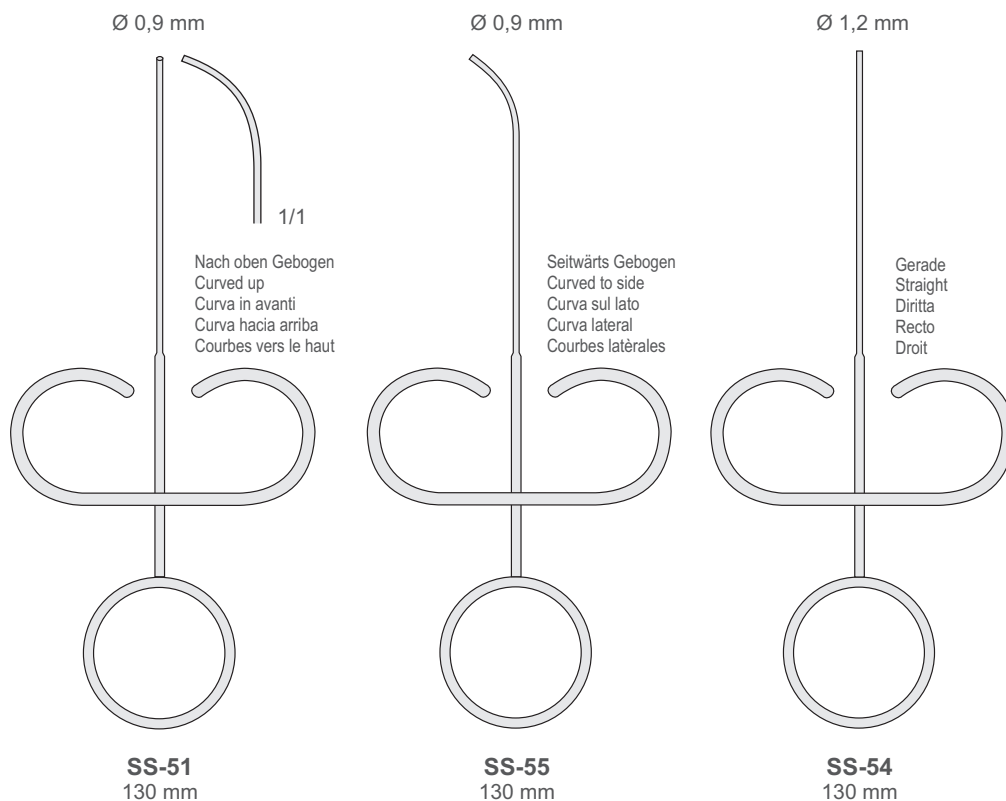

PERIO. ENDO
 & RESTORATION

inox StainlessSteel

Amalgambecher
Amalgam Well
Mortajo per amalgama
Vaso para amalgama
Gobelet pour amalgame



Knochenschale
Bone Well
Bacinella per osso
Cubeta para hueso
Cuvette à os

SS-65

Ø 35 x 35mm
depht 15 mm
5cc - 0.17oz

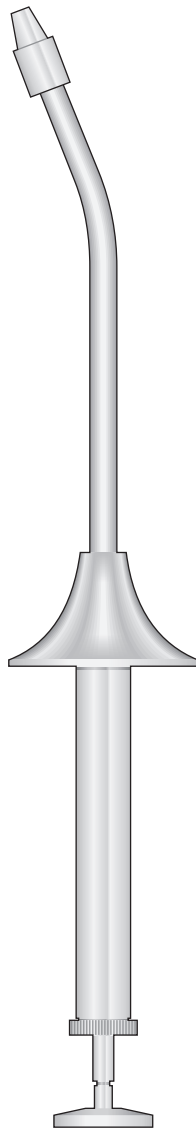

SS-15

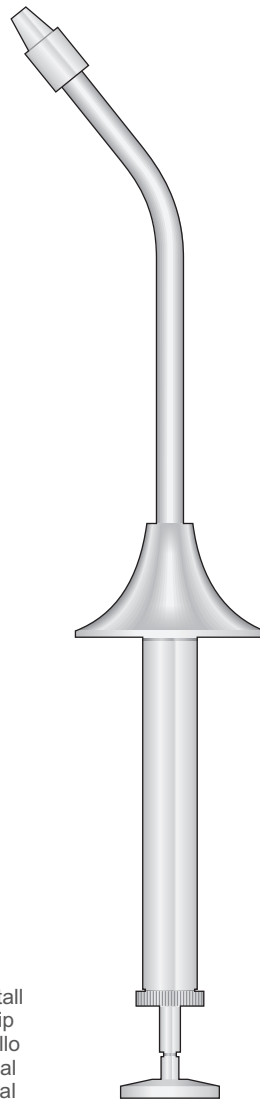

SS-16

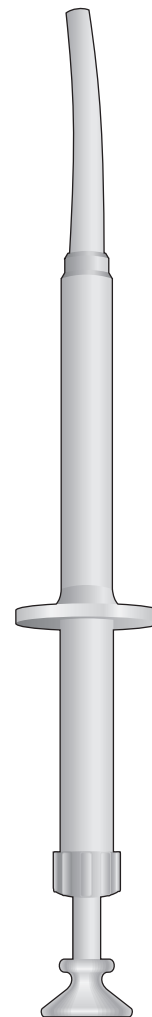

SS-41
170 mm

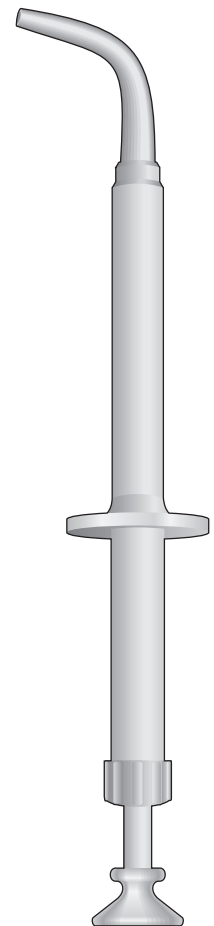

SS-42
160 mm

Aus Metall
Metal tip
In metallo
De metal
En métal

Autoclavable

Aus Kunststoff
Plastic tip
In plastica
De plàstico
En plastique



Titanium-coated
Titan-beschichtet
Recouvrement en Titane
Recubrimiento de Titanio
Ricoperto in Titanio

Fig. FE1



FELT
OT-1

Fig. FE2

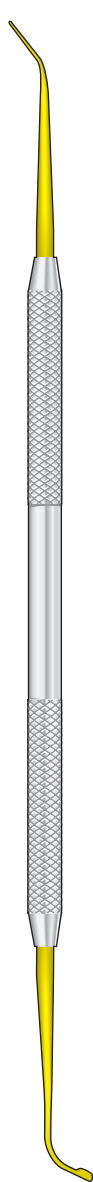

FELT
OT-2

Fig. FE3

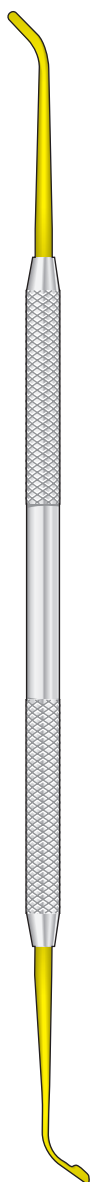

FELT
OT-3

Fig. FE4

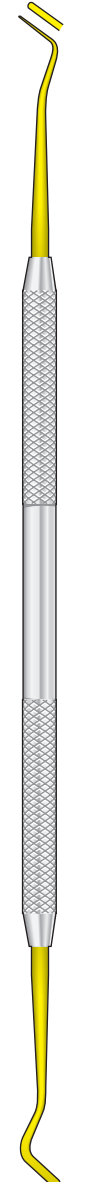

FELT
OT-4

Fig. FE5

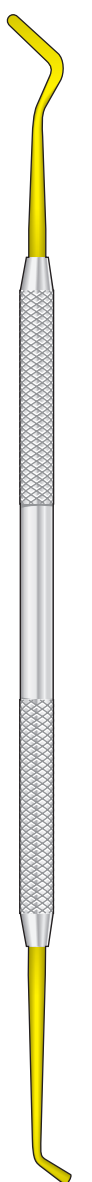

FELT
OT-5

Fig. FE6

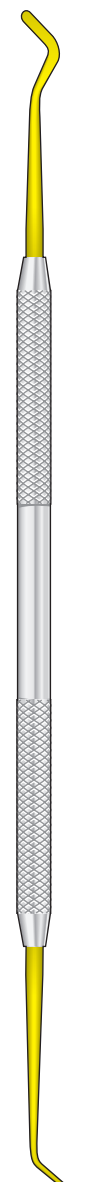

FELT
OT-6

Fig. GO1

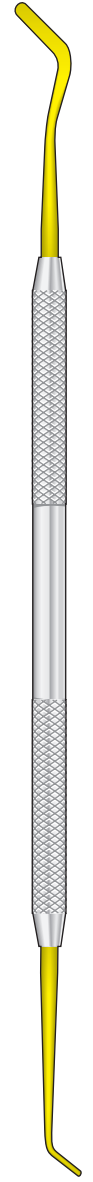

GOLDSTEIN
OT-7

Fig. GO2

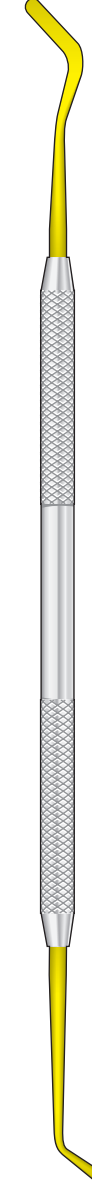

GOLDSTEIN
OT-8

Fig. GO3

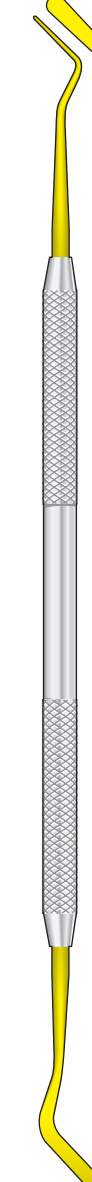

GOLDSTEIN
OT-9

Fig. GO4

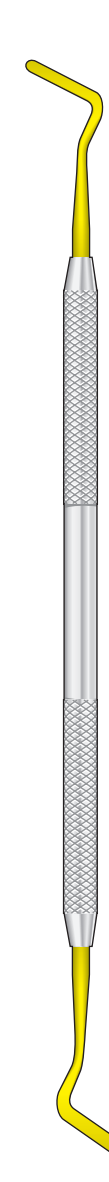

GOLDSTEIN
OT-10



Titanium-coated
Titan-beschichtet
Recouvrement en Titane
Recubrimiento de Titanio
Ricoperto in Titanio

Fig. CP1
1,5 mm



OT-11

Fig. CP2
2,0 mm



OT-12

Fig. CP3
2,0 mm



OT-13

Fig. CP4
2,5 mm



OT-14

Fig. CP5



OT-15

Fig. CP6

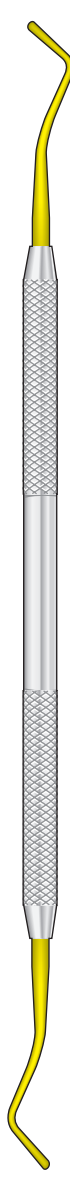

OT-16

Kompositinstrumente
Composite Instruments
Strumenti per composito
Instrumentos para composites
Instruments pour composites



FELT

GOLDSTEIN



FE-1

FE-2

FE-3

FE-4

FE-5

FE-6

FE-4/5

GO-1

GO-2

GO-3

GO-4

PERIO. ENDO
& RESTORATION

Spatulas

Zementspatel
Cement Spatulas
Spatole per cemento
Espátulas para cemento
Spatules à ciment

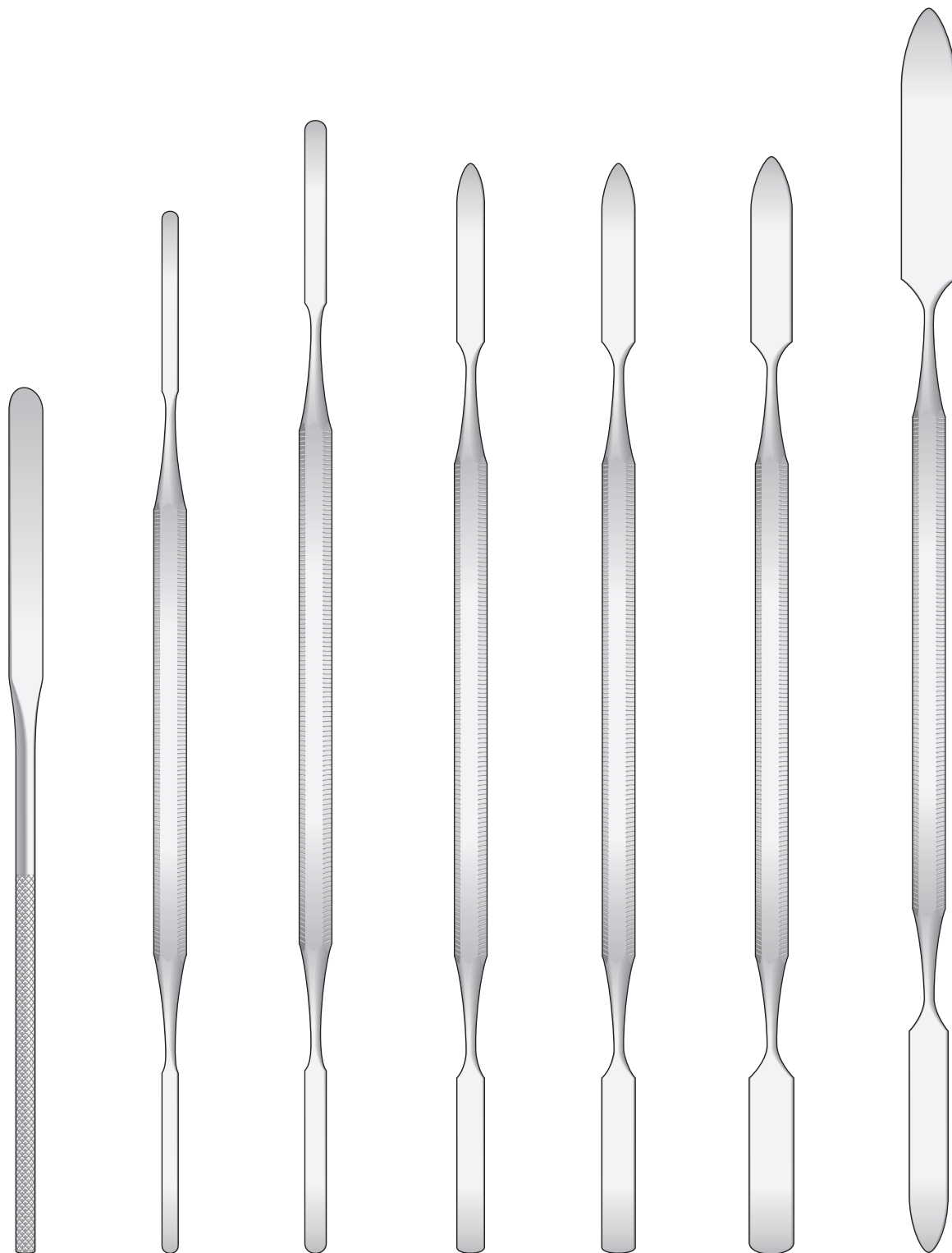

SR
140 mm

S-00
180 mm

S-0
185 mm

S-1
180 mm

S-2
180 mm

S-3
180 mm

S-4
200 mm

PERIO, ENDO
& RESTORATION

Füllungsinstrumente
 Filling Instruments
 Strumenti per otturazione
 Instrumentos para obturación
 Instruments pour obturation

Heidemann-Spateln
 Heidemann Spatulas
 Spatole Heidemann
 Espátulas Heidemann
 Spatules Heidemann

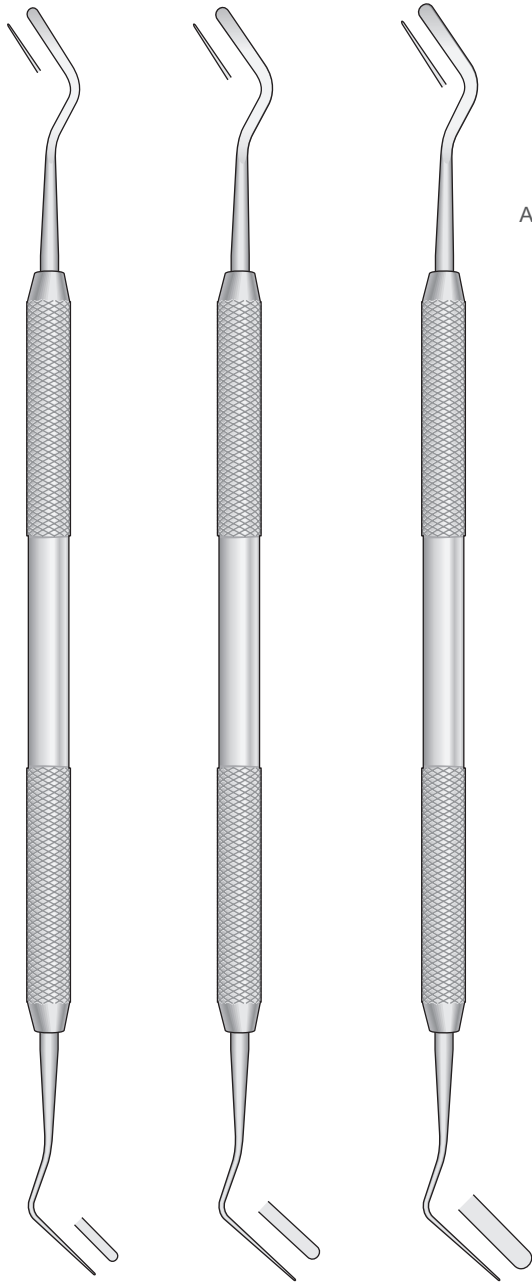

H-1
Fig. 1

H-2
Fig. 2

H-3
Fig. 3

A-1
125 mm

Dycal Applikator
 Placement Instrument
 Applicatore per sottofondo
 Aplicadores de fondo
 de cavidades
 Appliqueur de fond
 de cavité

Amalgam Instrumente
 Amalgam Carvers
 Strumenti per modellare l'amalgama
 Instrumentos para modelar las obturaciones
 Instruments à modeler l'amalgame

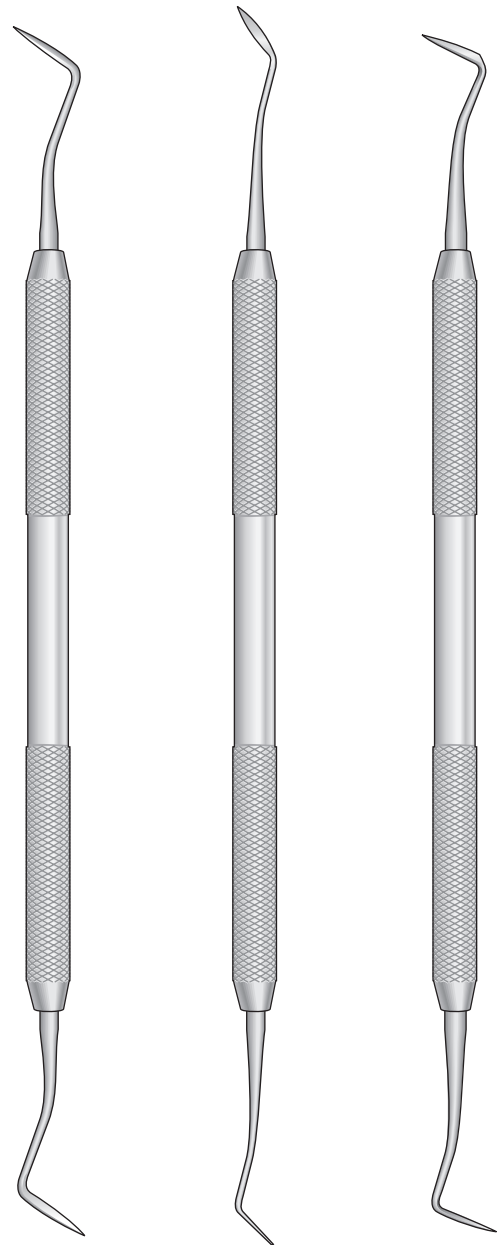

R-1
HOLLENBACH
1 - 165 mm

R-2
HOLLENBACH
1/2 - 165 mm

R-3
HOLLENBACH
3 - 165 mm

Instrument für Drahrückzug
 Instrument for retractor wire
 Strumento per filo retrattore
 Instrumento para hilo separador
 Instruments pour fil séparateur

Cleoids - Discoids

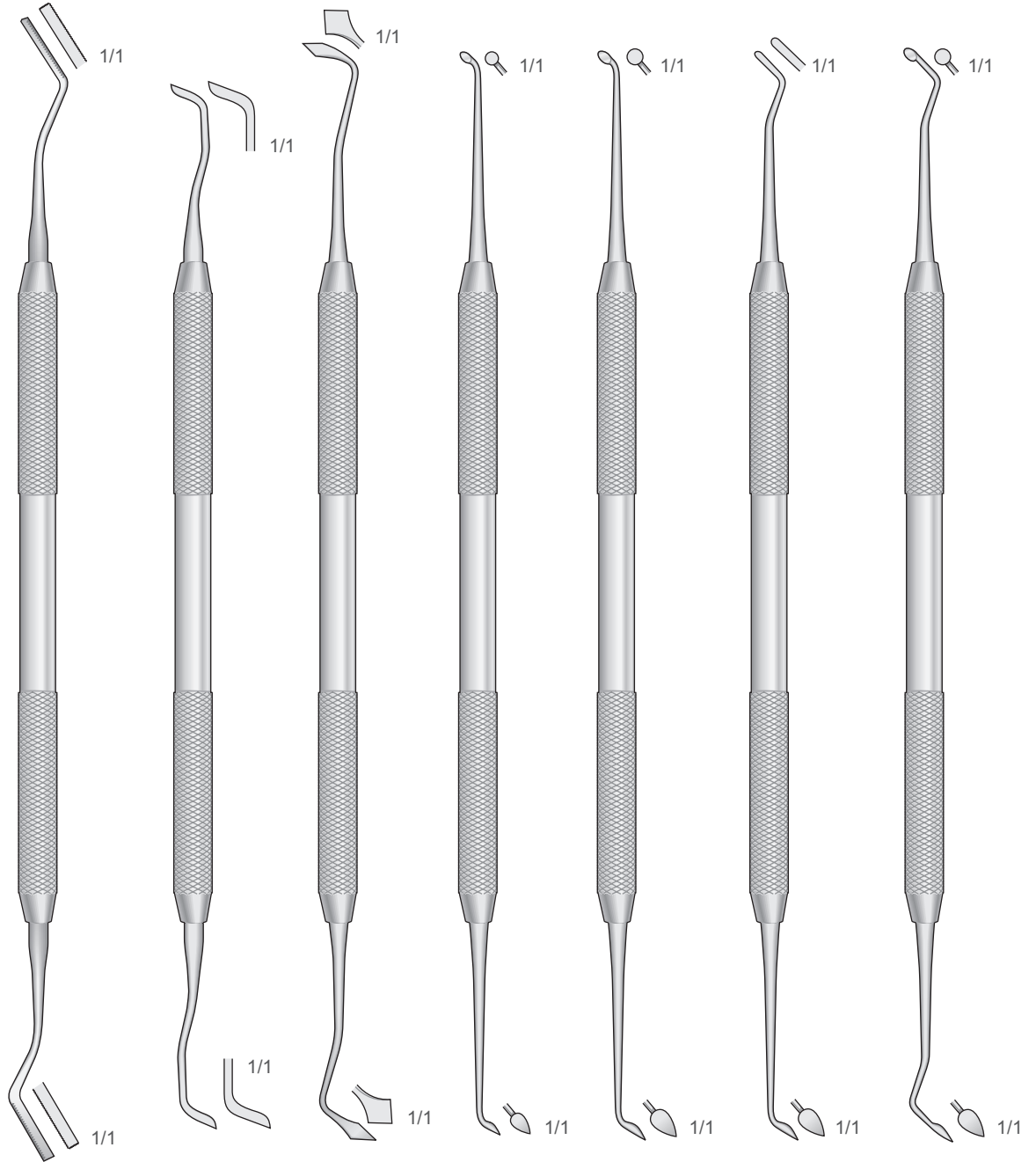

CV-11

USC-2
USC

F-2/3
FRAHM

CD-1
Fig. 1 / 2

CD-2
Fig. 4/5

CD-3
Fig. W.A.C.D.

CD-4
Fig. 3/6

Füllungsinstrumente
Filling Instruments
Strumenti per otturazione
Instrumentos para obturación
Instruments pour obturation

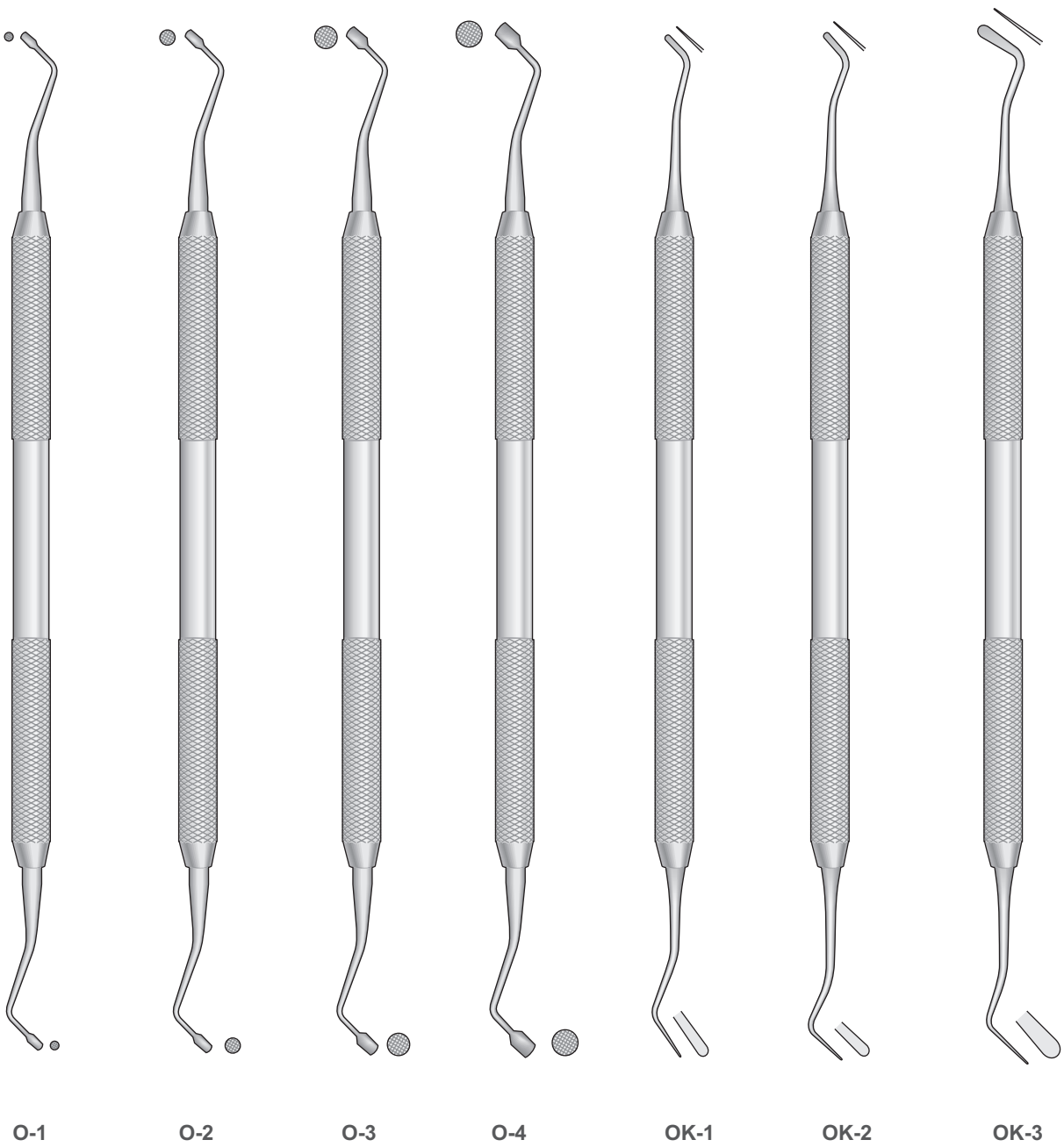

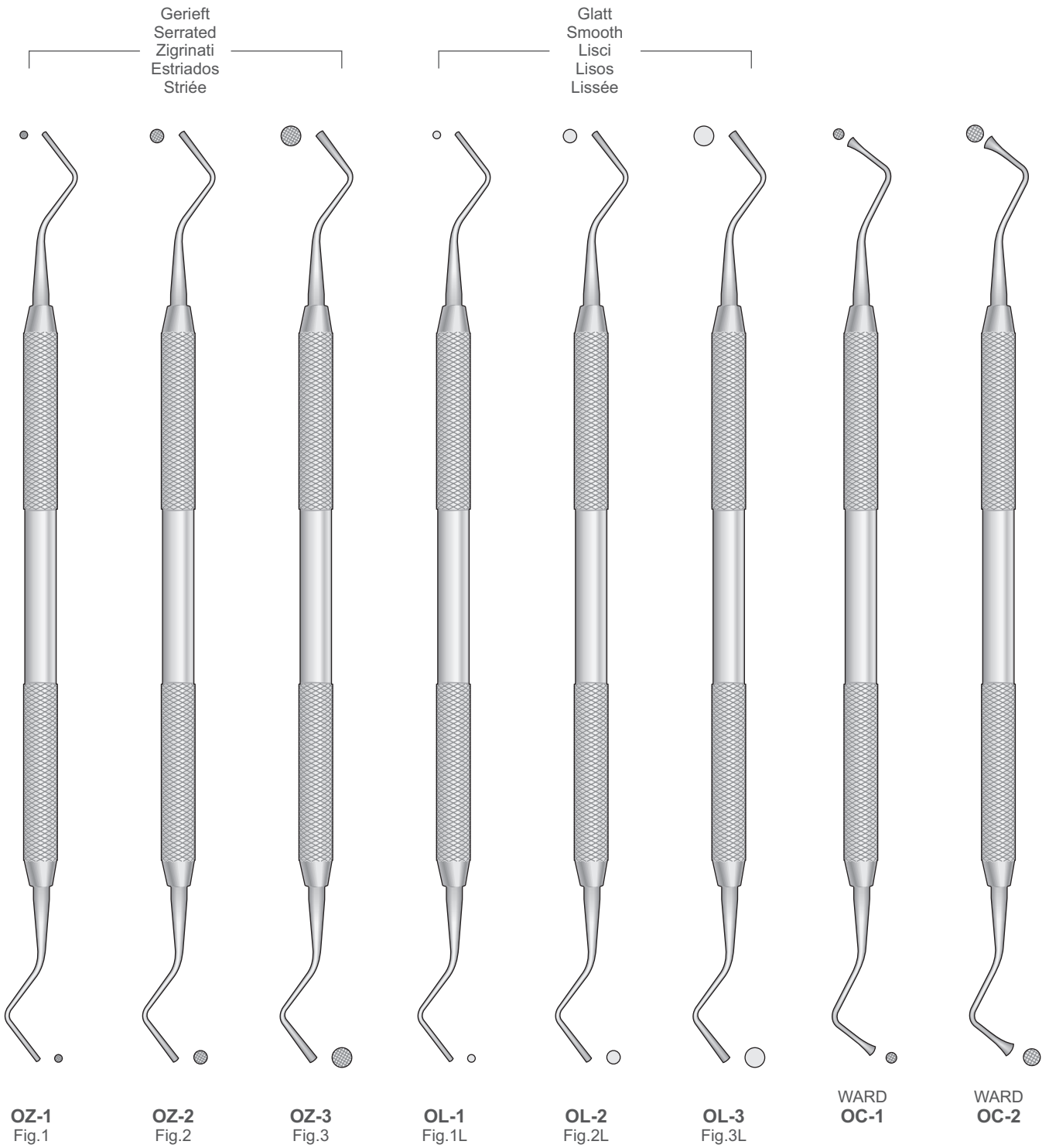

Füllungsinstrumente
Filling Instruments
Strumenti per otturazione
Instrumentos para obturación
Instruments pour obturation

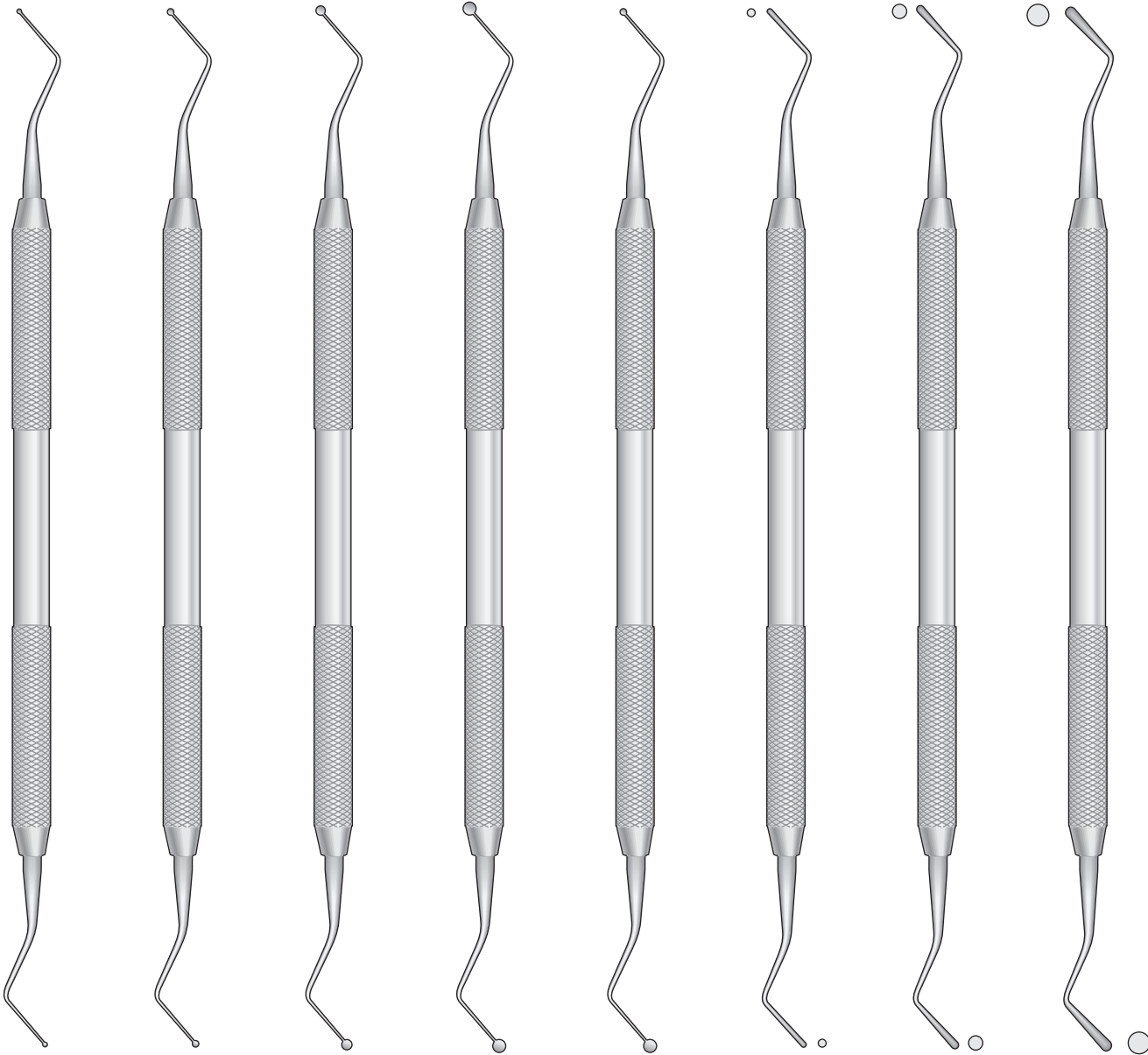

OP-1
Fig.1

OP-2
Fig.2

OP-3
Fig.3

OP-4
Fig.4

OP-5
Fig.5

OA-1
Fig.1

OA-2
Fig.2

OA-3
Fig.3

PERIO. ENDO
& RESTORATION

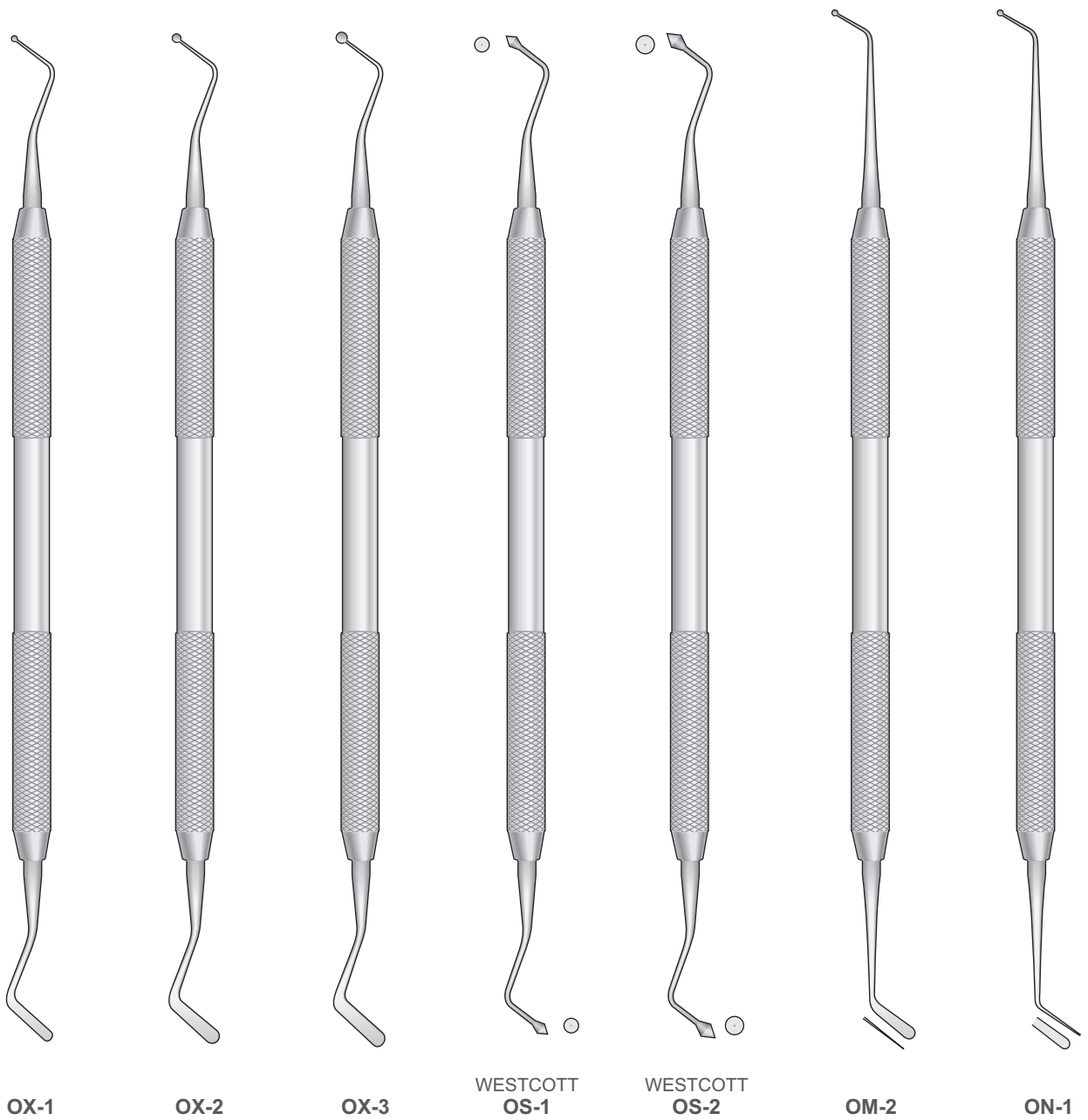

Füllungsinstrumente
Filling Instruments
Strumenti per otturazione
Instrumentos para obturación
Instruments pour obturation

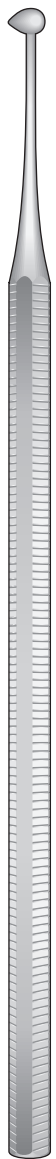

WHITE
B-3
n°28



WHITE
B-4
n°29

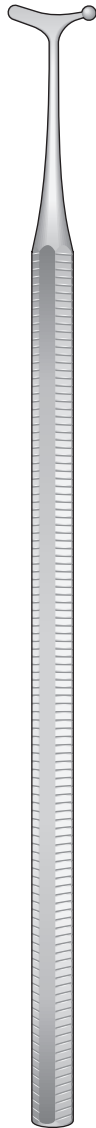

WHITE
B-32
n°32

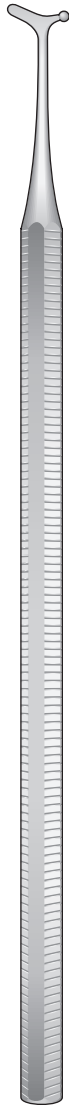

WHITE
B-33
n°33

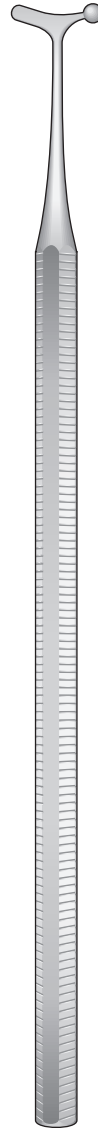

WHITE
B-34
n°34



WHITE
B-28/29
Doppio

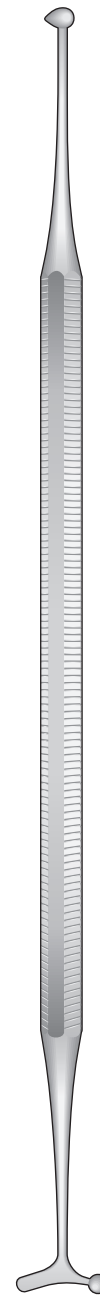

WHITE
B-31/32
Doppio

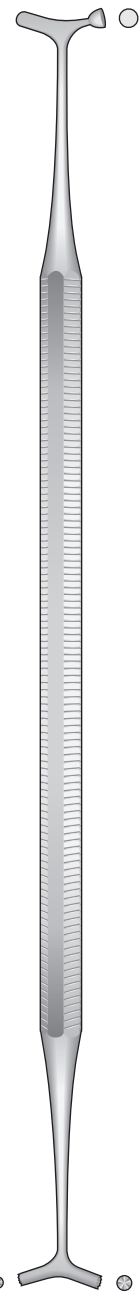

BENNET
B-35
170 mm

MARKLEY PLUGGERS
Amalgam Instrumente
Amalgam Instruments
Strumenti per amalgama
Instrumentos para amalgama
Instruments à amalgame

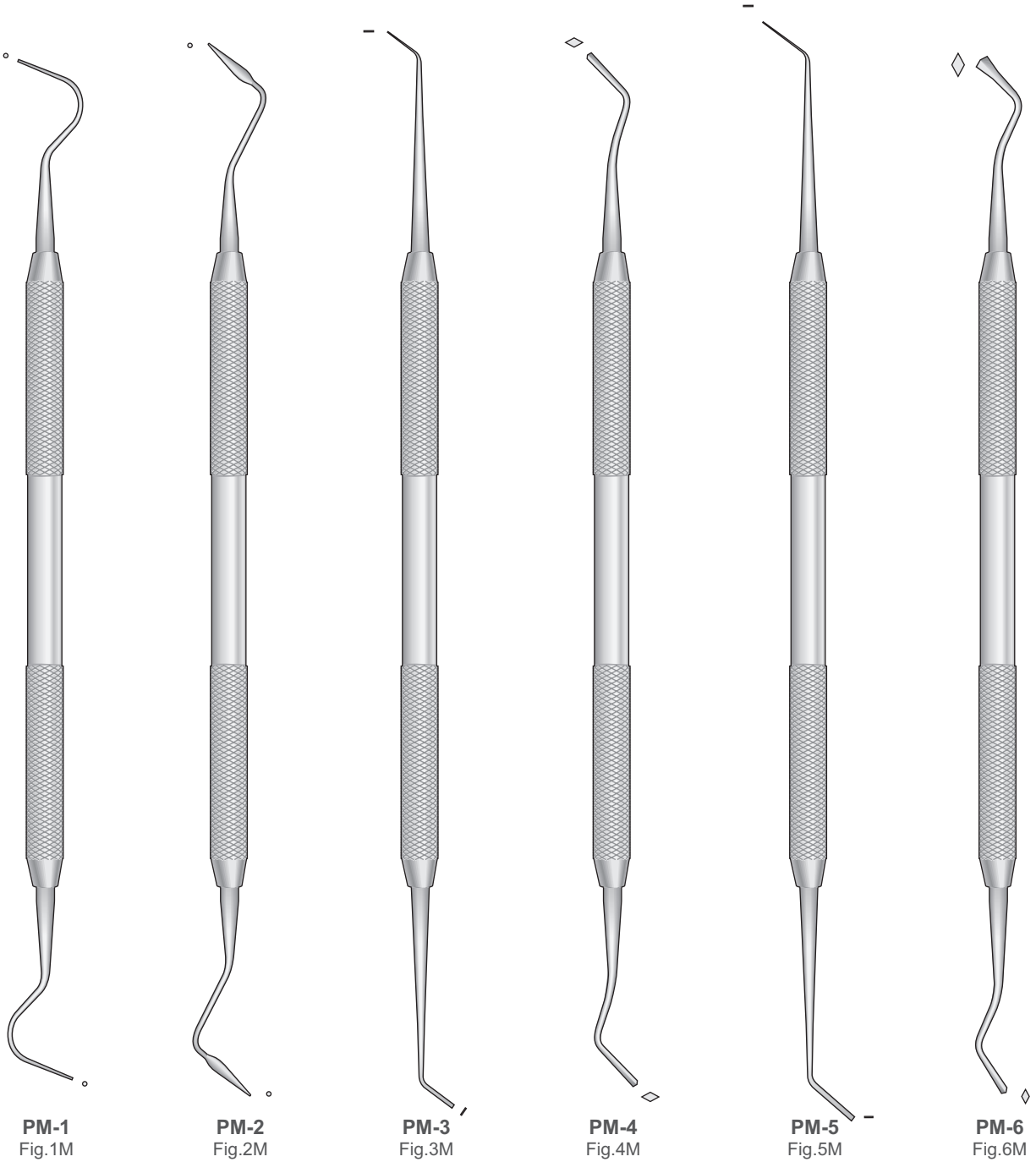

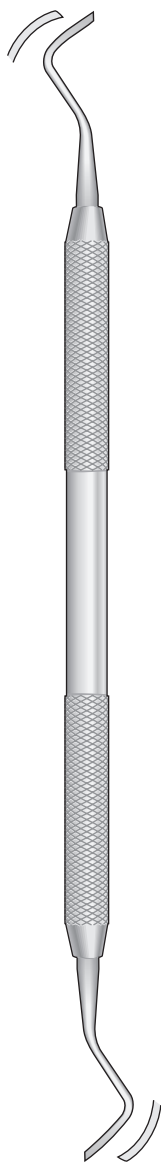

BLACK
TS-1
Fig.26

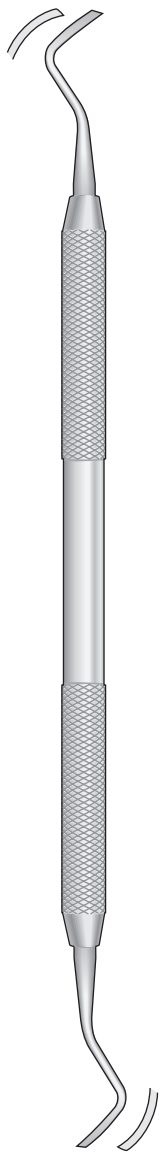

BLACK
TS-2
Fig.27

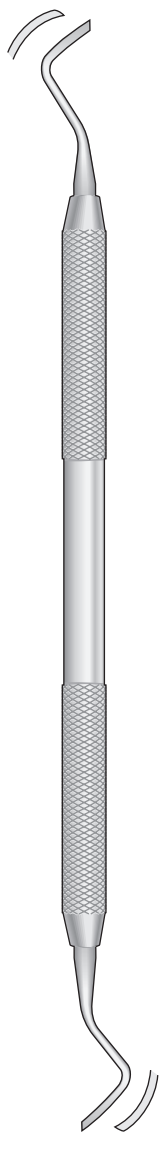

BLACK
TS-3
Fig.28

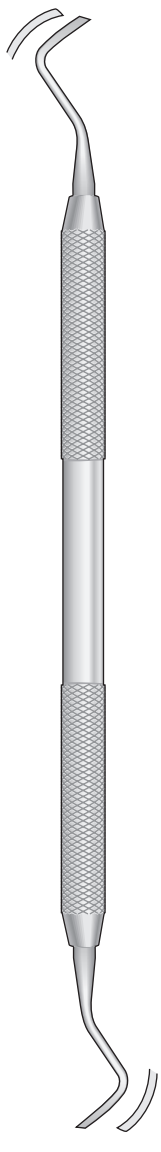

BLACK
TS-4
Fig.29

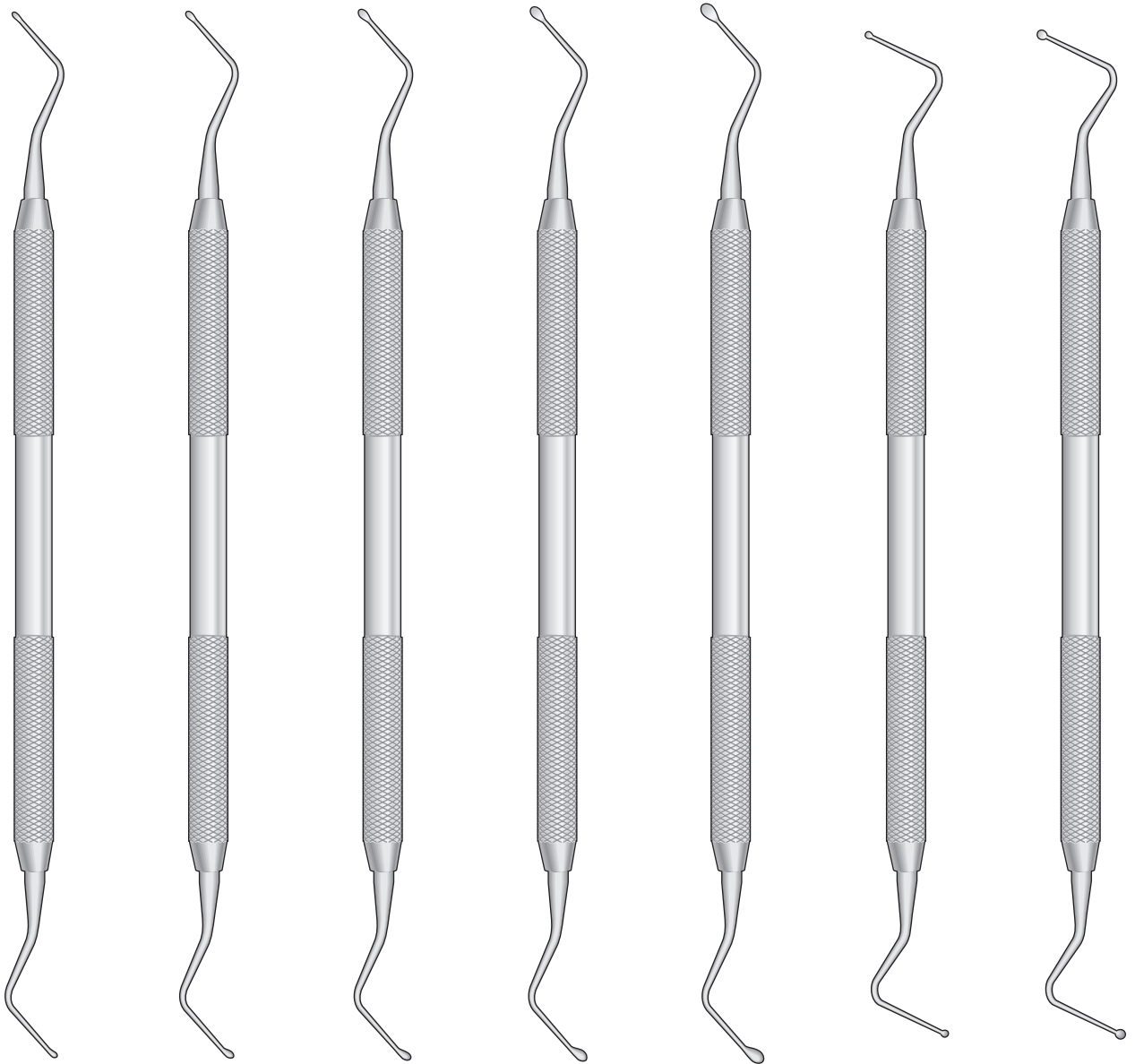

E-0
Fig.0

E-1
Fig.1

E-2
Fig.2

E-3
Fig.3

E-4
Fig.4

EC-1
Fig.1

EC-2
Fig.2

Fig. 1

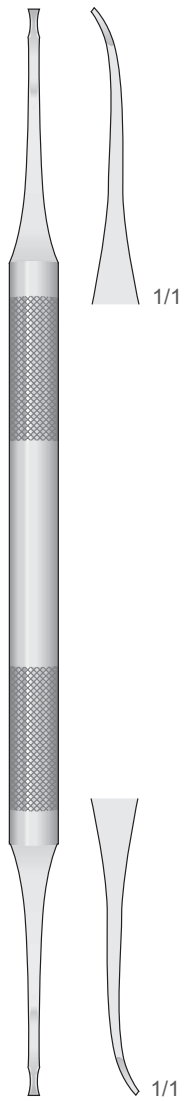

FEDI
OF-1
175 mm

Fig. 2

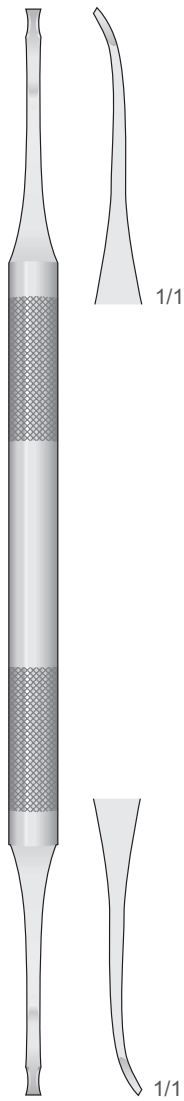

FEDI
OF-2
175 mm

Fig. 3



FEDI
OF-3
170 mm

Fig. 4

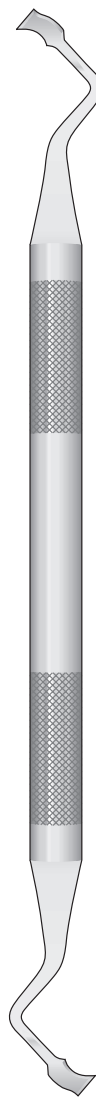

OCHSENBEIN
OSB-4A
170 mm



OCHSENBEIN
OSB-4
170 mm

Bevel IN
 Fig.1



OCHSENBEIN-1
OSB-1
 165 mm

Bevel OUT
 Fig.2



OCHSENBEIN-2
OSB-2
 165 mm



TG CHISELS
718-113



OCHSENBEIN-3
718-103

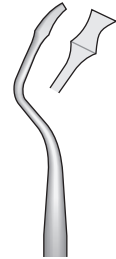

OCHSENBEIN-4
718-104

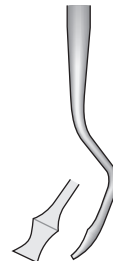

RHODES BACK ACTION
718-107



Parodontalmesser
Gingivectomy Knives
Bisturi per gengivectomia
Bisturíes para la gengivectomía
Bistouris pour la gengivectomie

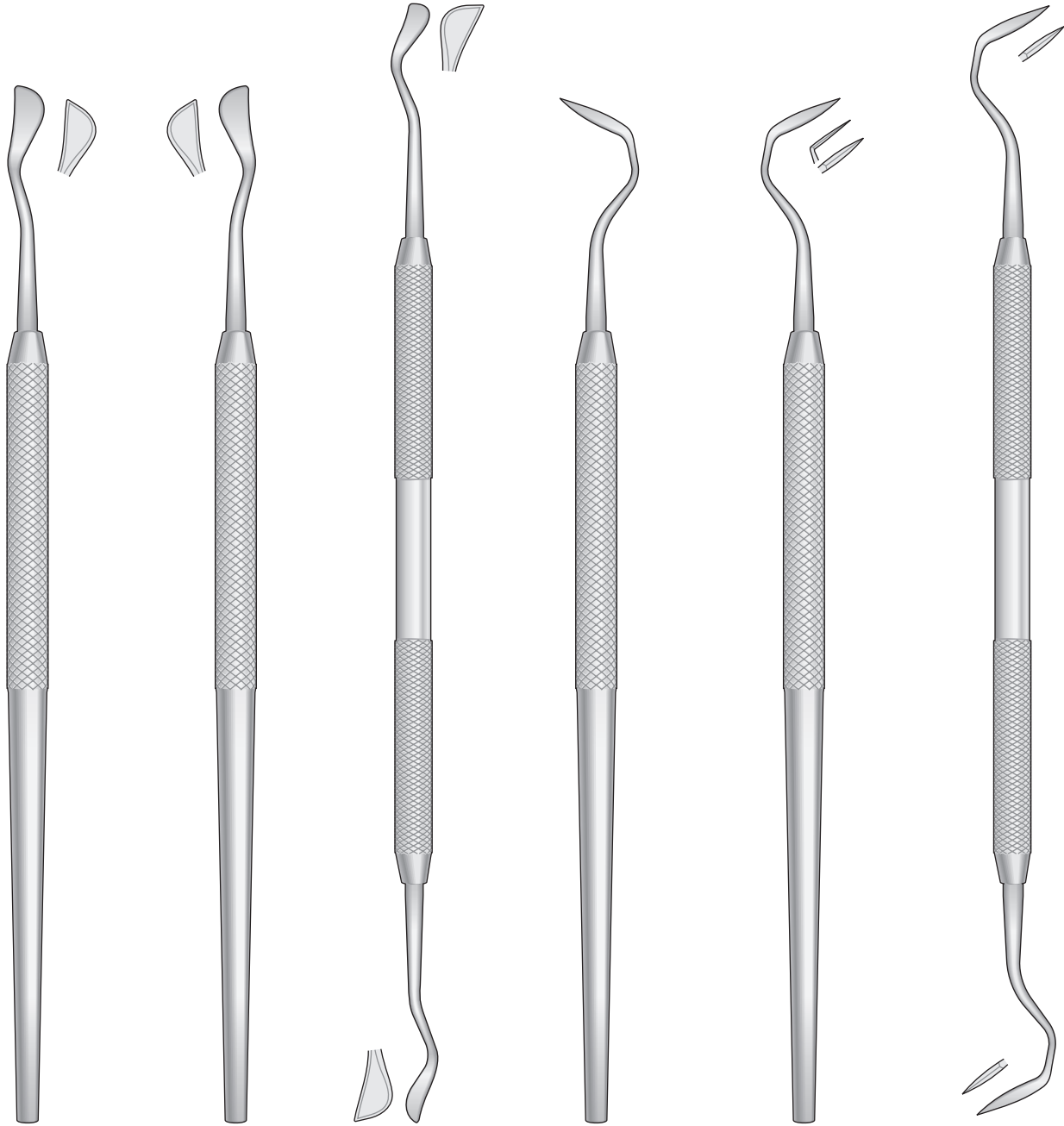

**KIRKLAND
KKD-1**
Fig.15K

**KIRKLAND
KKD-2**
Fig.16K

**KIRKLAND
KKD-4**
Fig.15K - Fig.16K

**ORBAN
OBN-1**
Fig.1

**ORBAN
OBN-2**
Fig.2

**ORBAN
OBN-4**
Fig.1 - Fig.2

PERIO. ENDO
& RESTORATION

Doppelendiger Zahnsonden
 Double-ended Explorer
 Sonda falce doppia
 Sonda exploradora doble
 Sonde exploratrice double

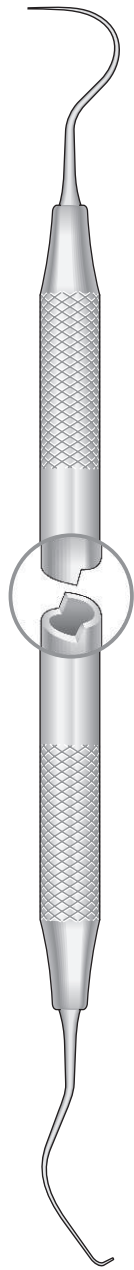

707-23D1
 Fig.23/17



707-23D2
 Fig.23/17A



707-16D1
 Fig.6/23



707-16D2
 Fig.6/3



707-UT1
 Fig.UT1/2



707-202
 Fig.2



707-202A
 Fig.2A



707-203
 Fig.3



707-6D1
 Fig.5/6



707-6D2
 Fig.16/17



707-6D3
 Fig.16/23

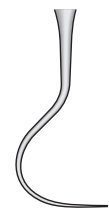

Doppelendiger Parodontometer
 Double-ended Periodontal Probes
 Sondes parodontales doubles
 Sonde parodontali doppie
 Sondas parodontales doubles

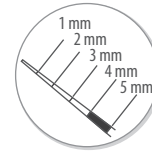
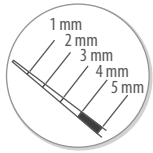

GOLDMANN-FOX

GOLDMANN-FOX
WILLIAMS

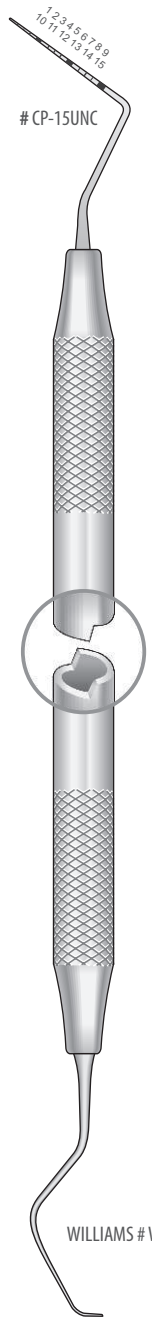

707-1715
 # CP-15UNC-17A
 170 mm

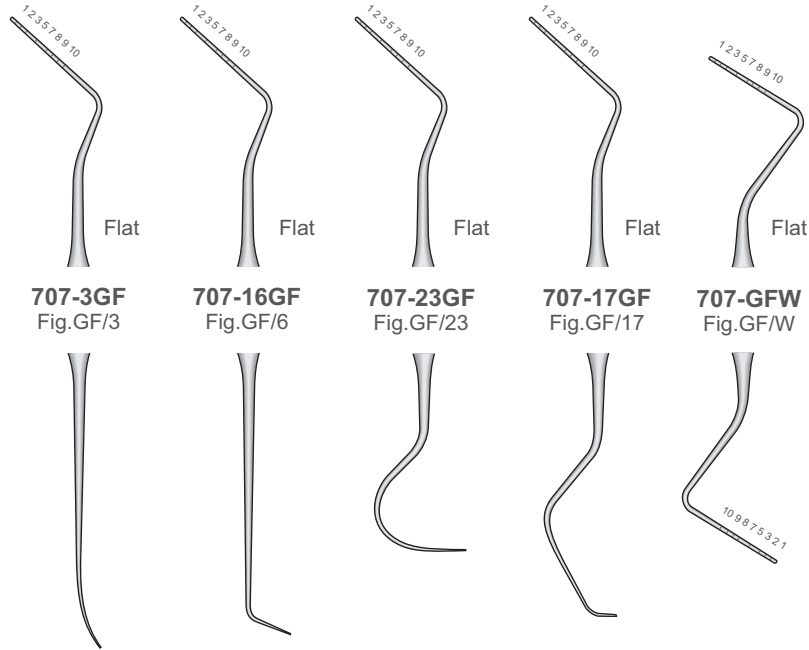

WILLIAMS

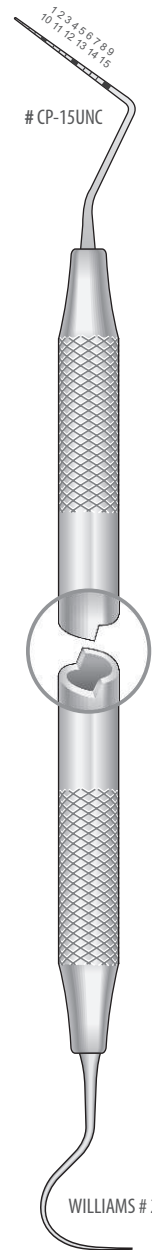
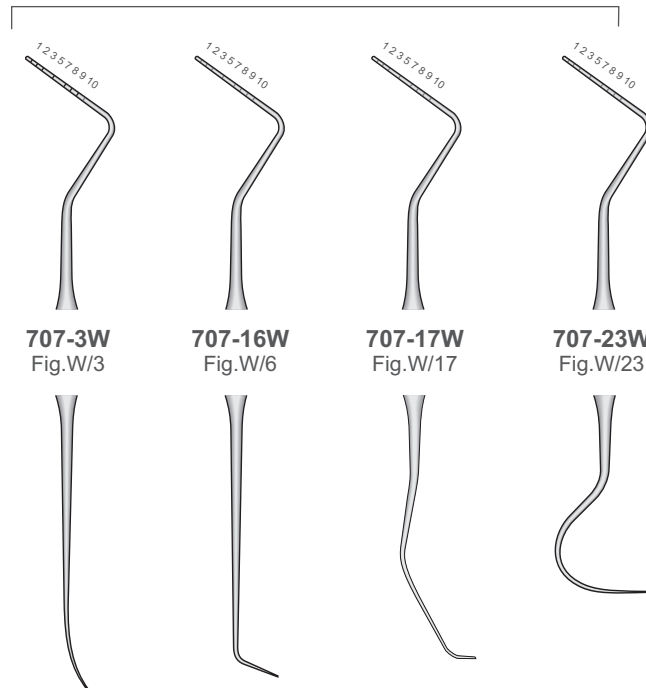

707-2315
 # CP-15UNC-23/W
 170 mm

PERIO. ENDO
& RESTORATION

UNIVERSITY OF MICHIGAN

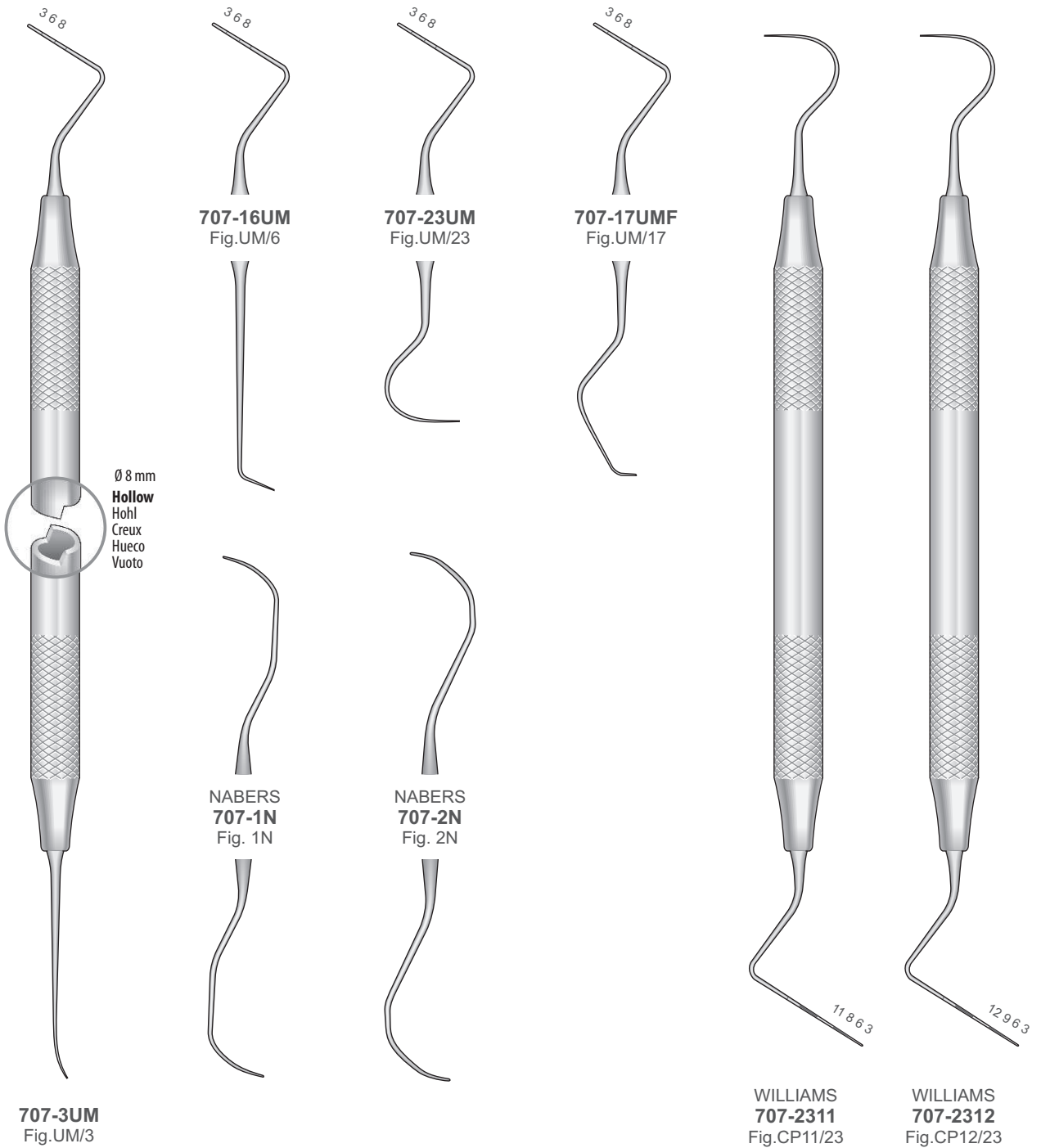

Spateln - Füllungsinstrumente
 Spatulas - Filling Instruments
 Spatole - Strumenti per otturazione
 Espátulas - Instrumentos para obturación
 Spatules - Instruments pour obturation

Heidemann Spateln
 Heidemann Spatulas
 Spatole Heidemann
 Espátulas Heidemann
 Spatules Heidemann

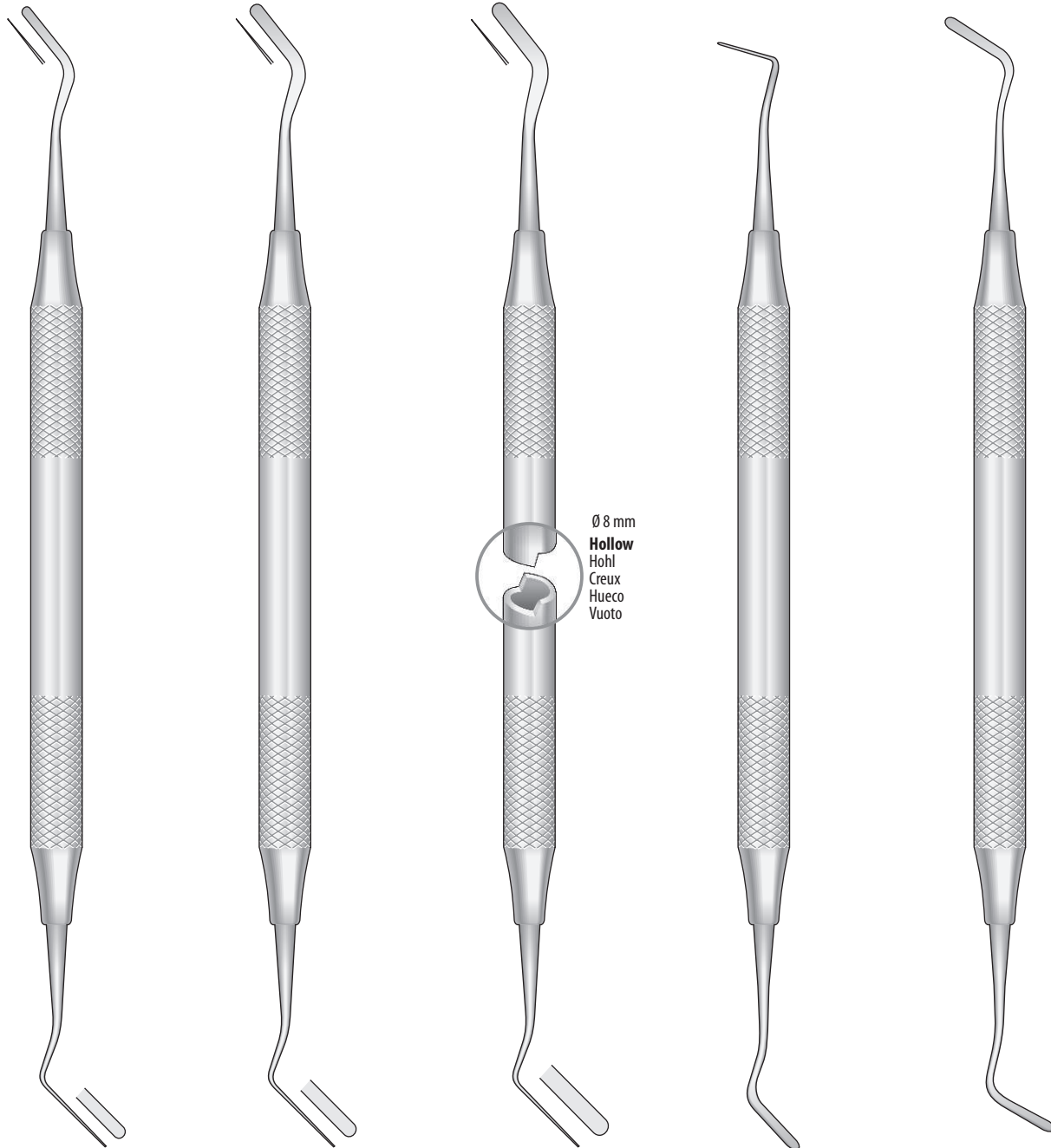

HEIDEMANN
711-301
 Fig.1

HEIDEMANN
711-302
 Fig.2

HEIDEMANN
711-303
 Fig.3

IPC Fig. 1
715-311
 Interproximal

IPC/OA Fig. 2
715-312
 Interproximal Off-Angle

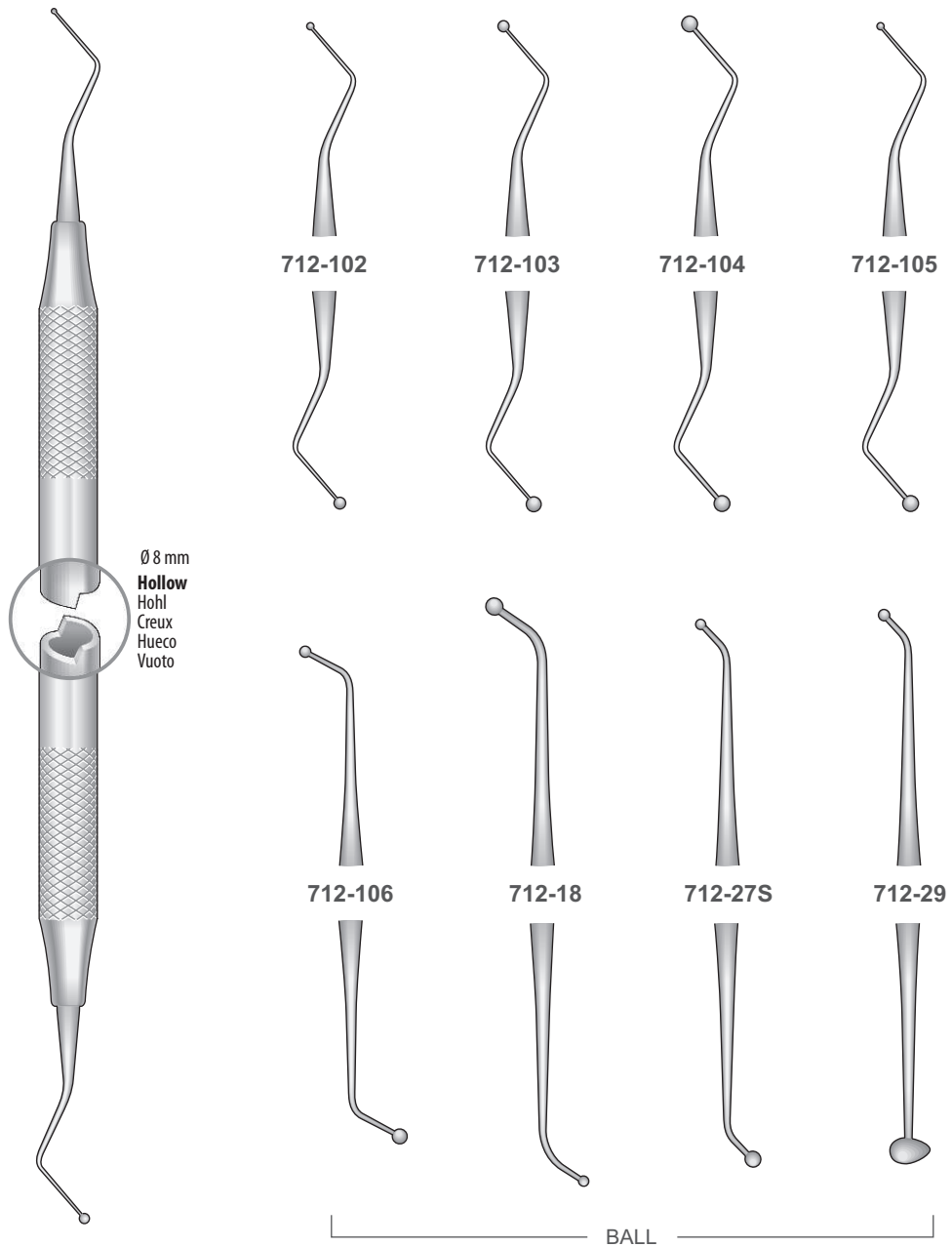

712-101

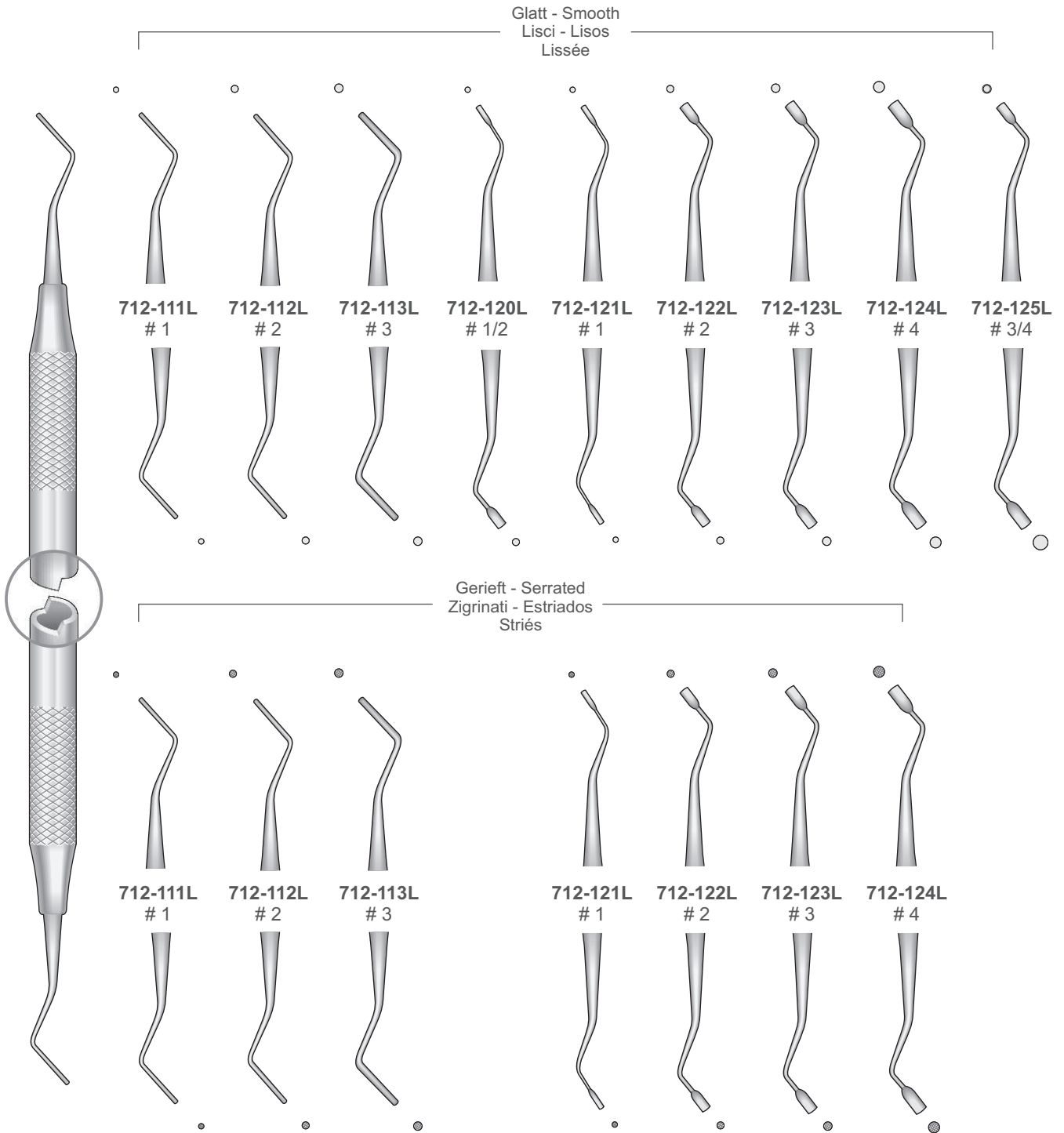

HOLLENBACK



Ø 8 mm
Hollow
 Hohl
 Creux
 Hueco
 Vuoto

712-PFI
 170 mm



712-161H



712-162H



712-163H



712-164H

MARKLEY PLUGGERS



714-101



714-102

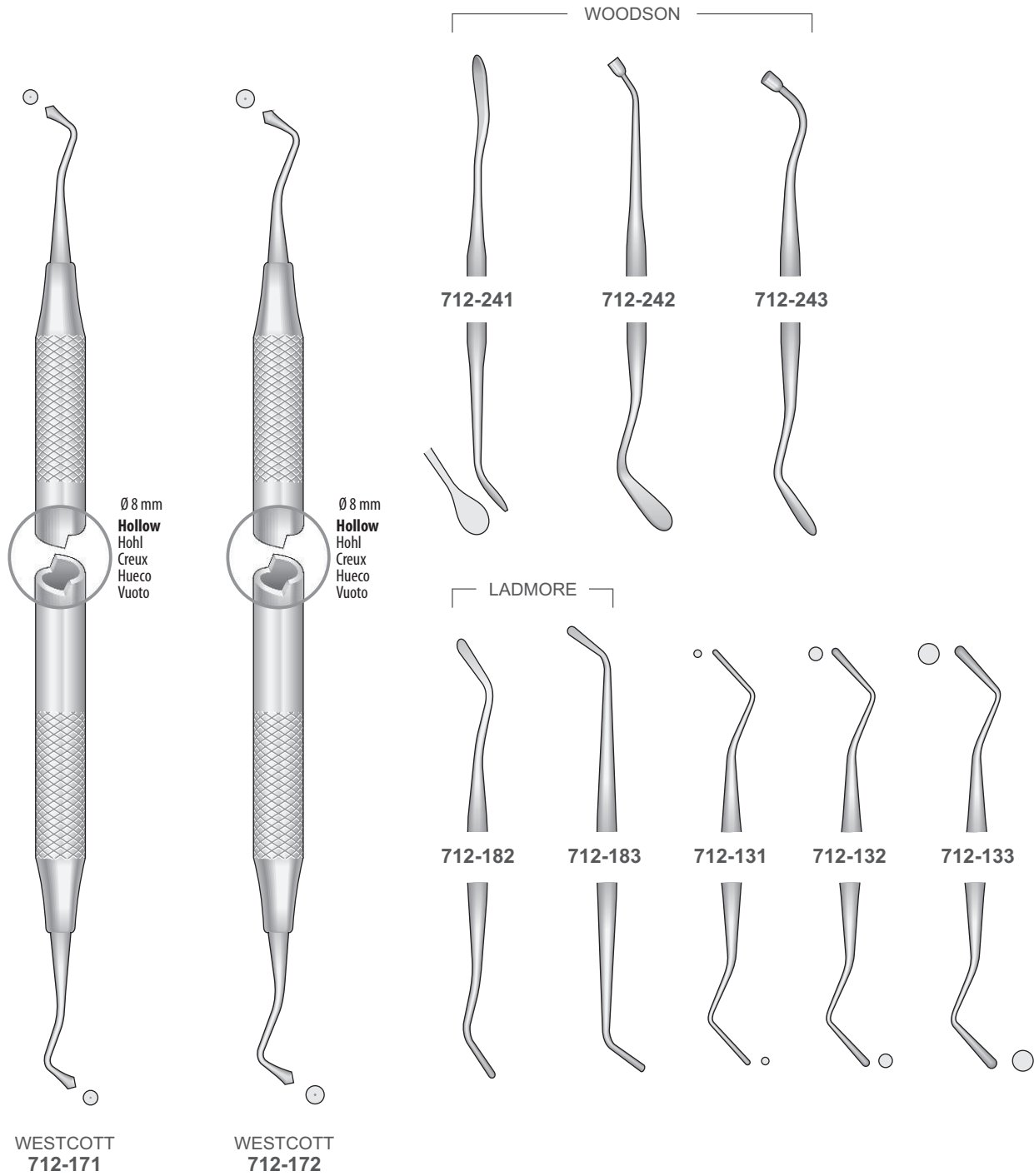

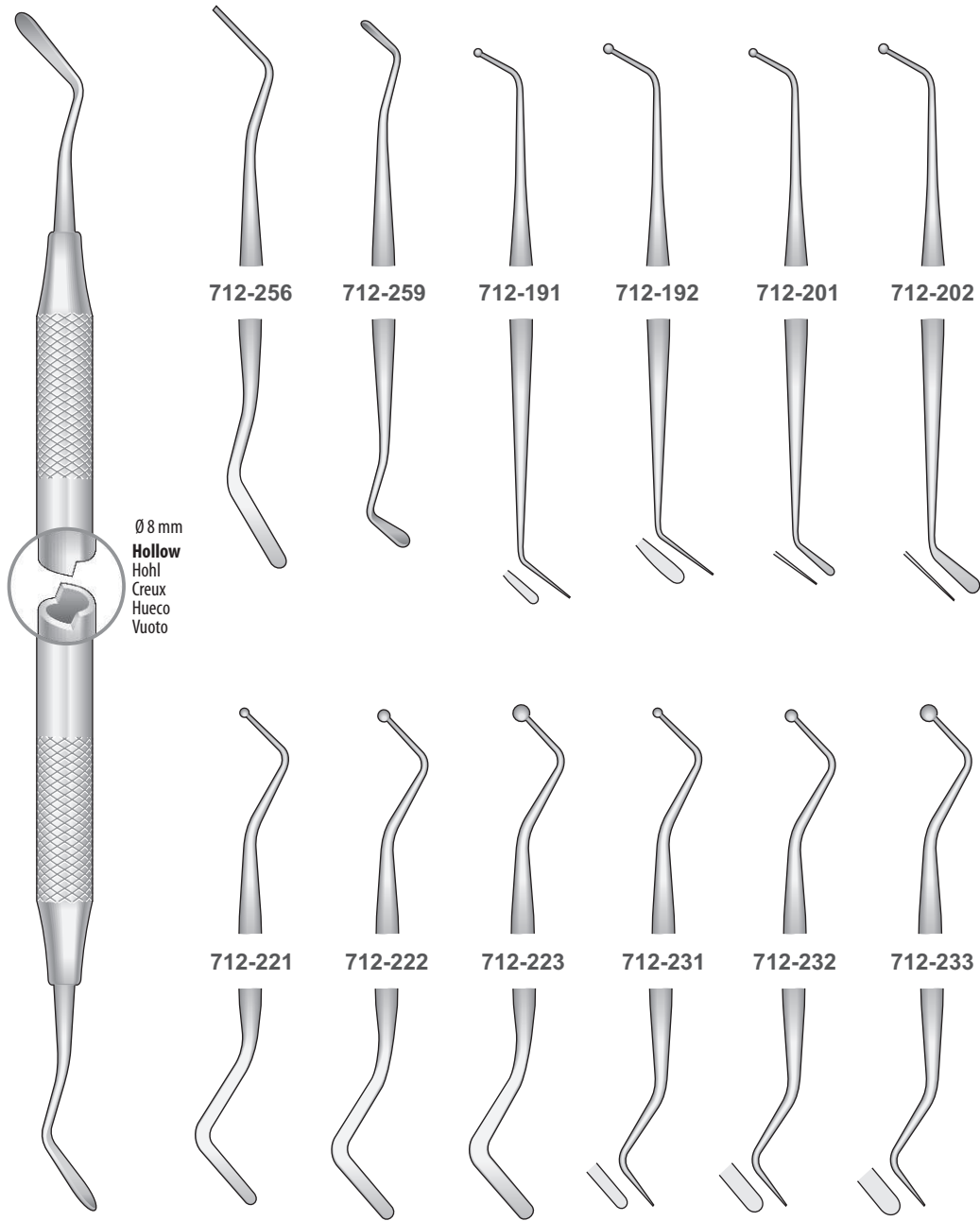

Ø 8 mm
Hollow
 Hohl
 Creux
 Hueco
 Vuoto

712-251

Amalgam Instrumente
Amalgam carvers
Strumenti per modellare otturazioni
Instrumentos para modelar las obturaciones
Instruments à modeler les obturations

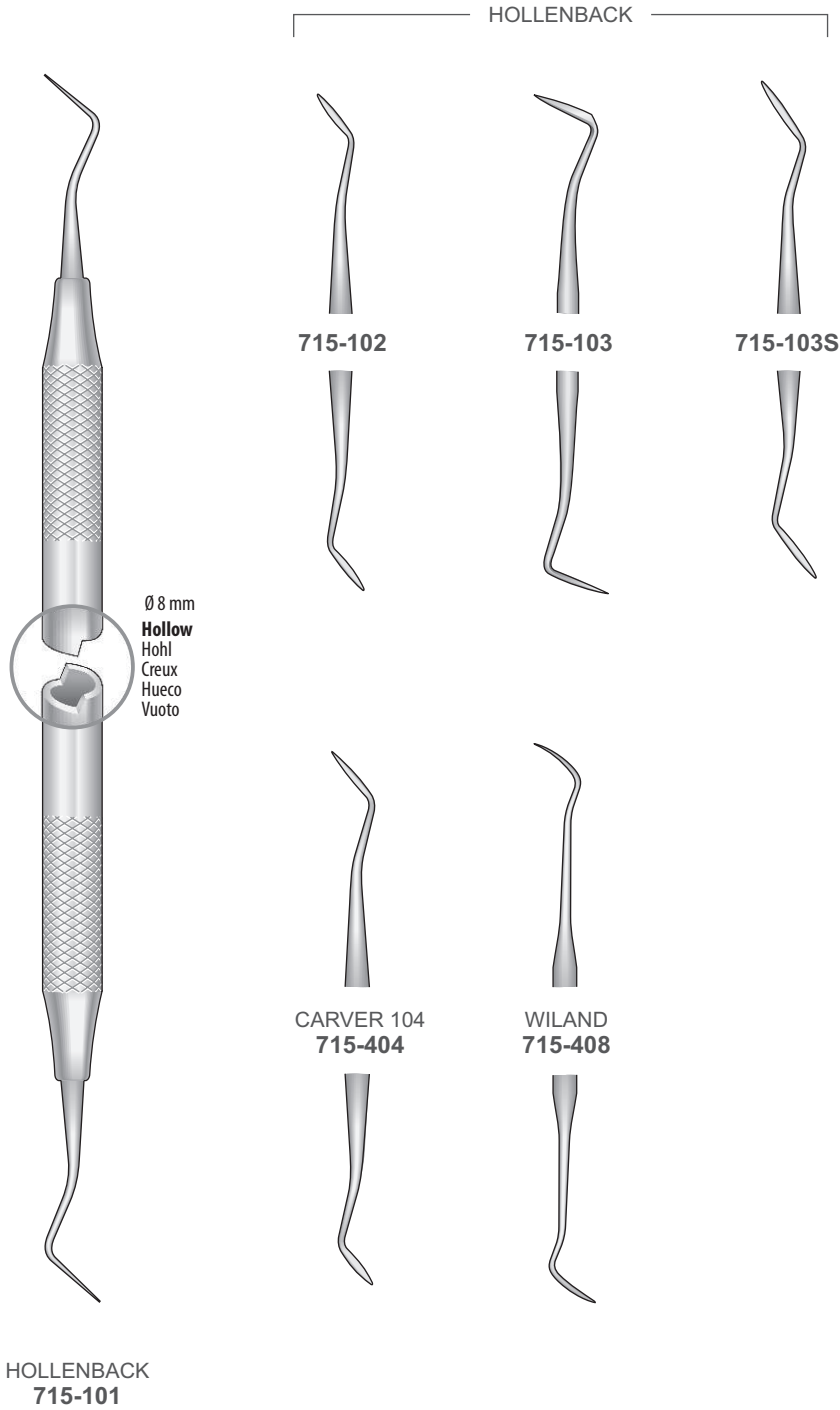

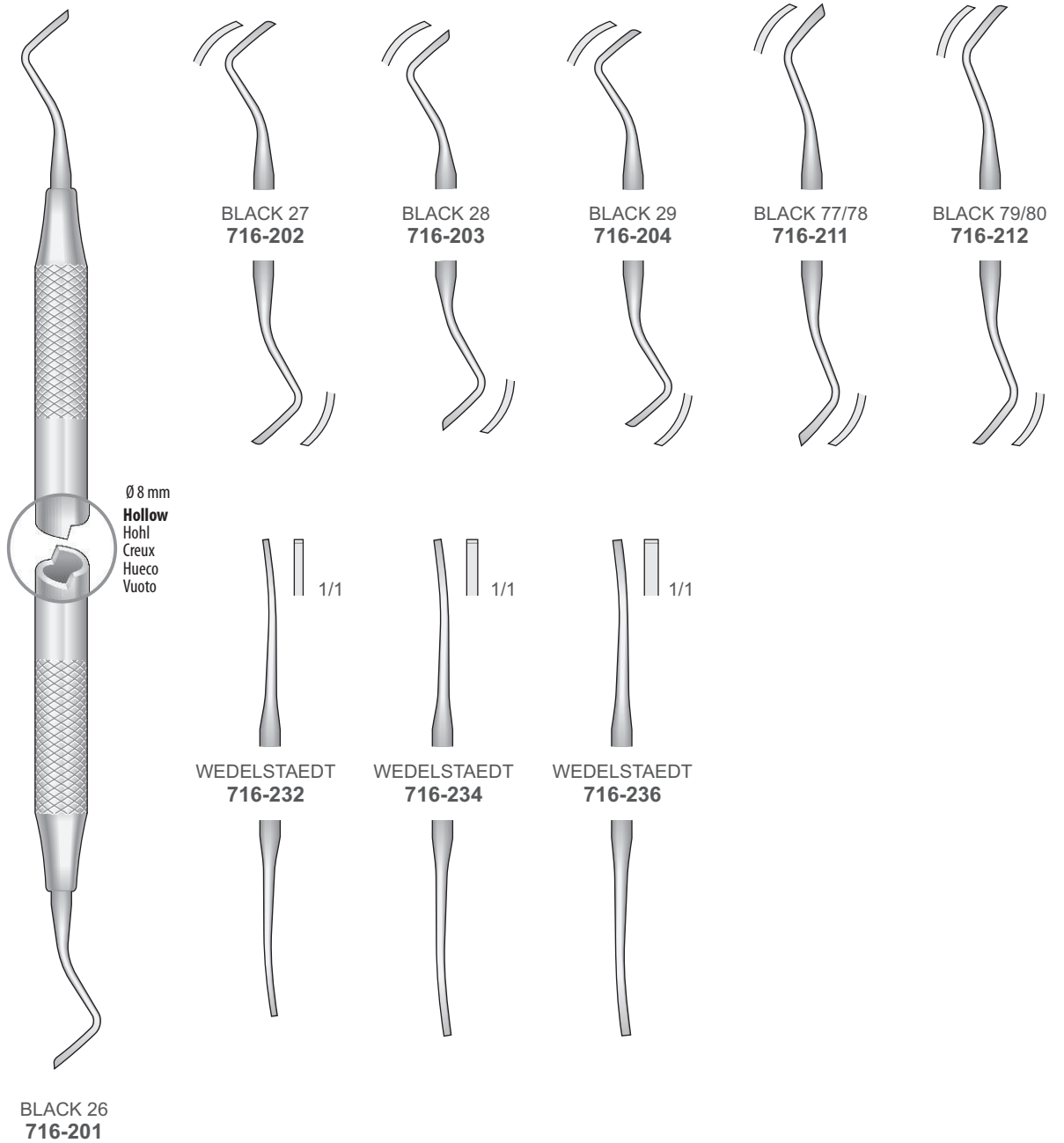

Amalgam Instrumente
 Amalgam carvers
 Strumenti per modellare otturazioni
 Instrumentos para modelar las obturaciones
 Instruments à modeler les obturations

Instrument für Drahrückzug
 Instrument for Retractor wire
 Strumento per filo retrattore
 Instrumento para hilo retractor
 Instruments pour fil racteur

Cleoids - Discoids

Dykal Applikator
 Placement Instruments
 Applicatori per sottofondo
 Aplicadores de fondo de cavidades
 Appicateurs de fond de cavité

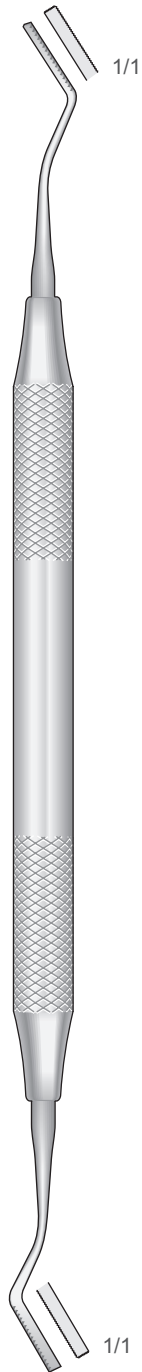

714-CV11

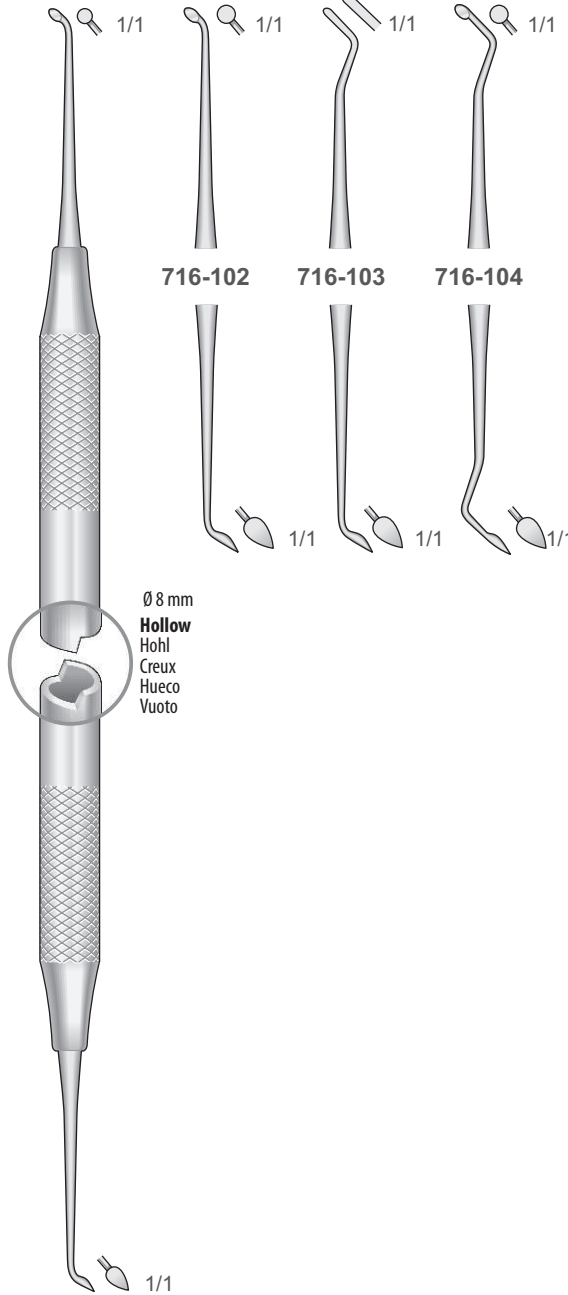

716-101

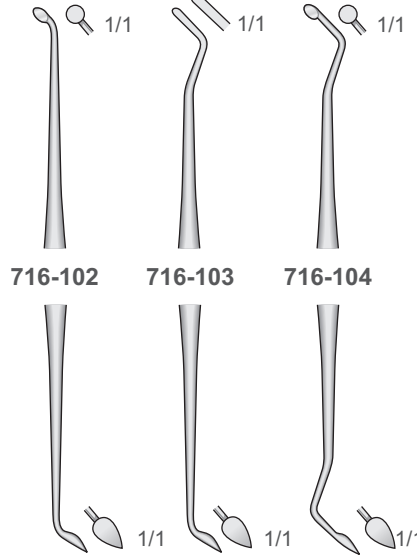

Ø 8 mm
Hollow
 Hohl
 Creux
 Hueco
 Vuoto

Ø 8 mm
Hollow
 Hohl
 Creux
 Hueco
 Vuoto

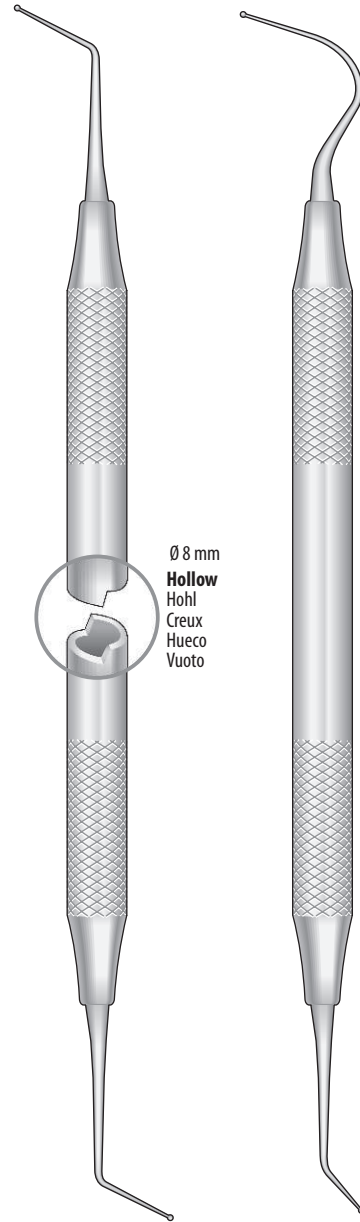

713-101

713-102

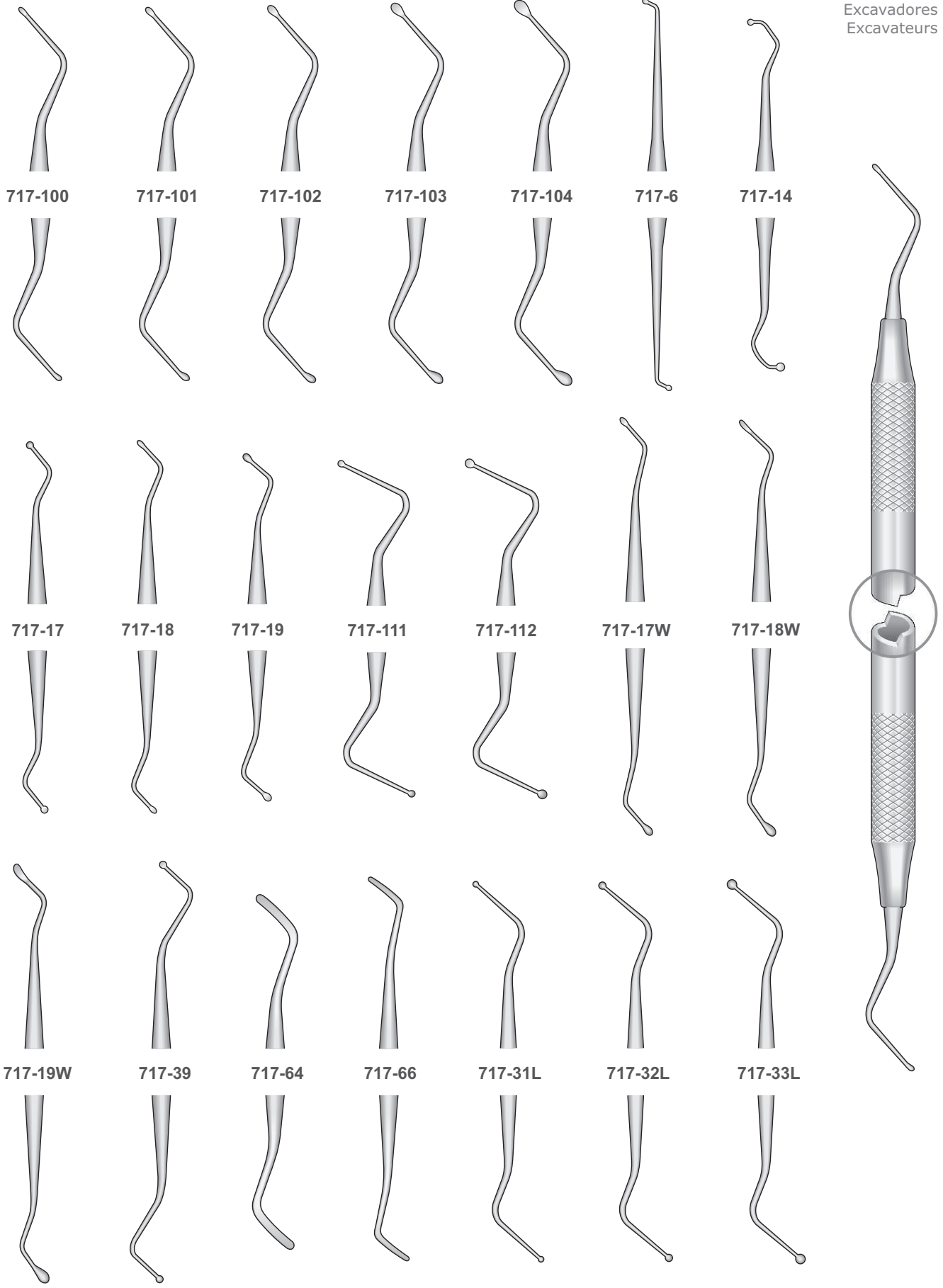

Parodontalmesser
 Gingivectomy knives
 Bisturi per gengivectomia
 Bisturías para la gingivectomía
 Bistouris pour la gingivectomie

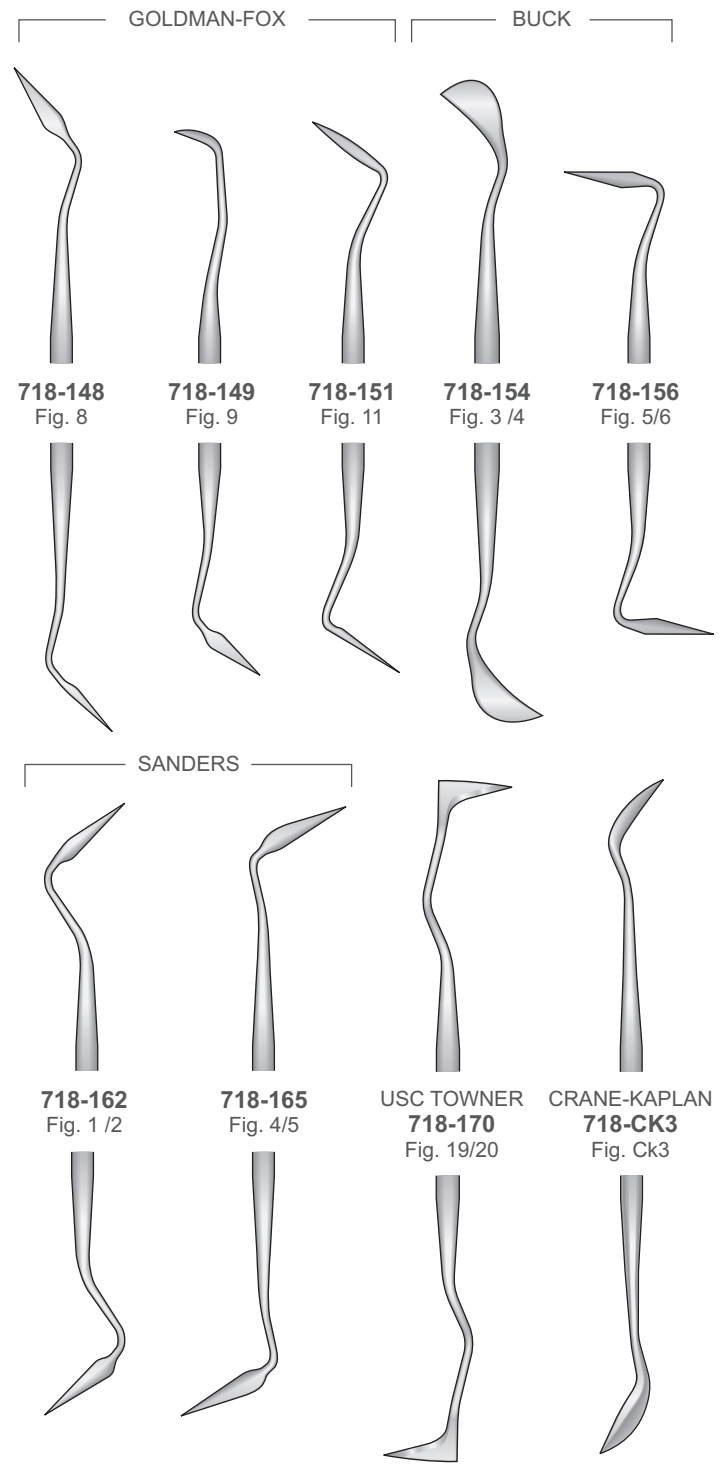
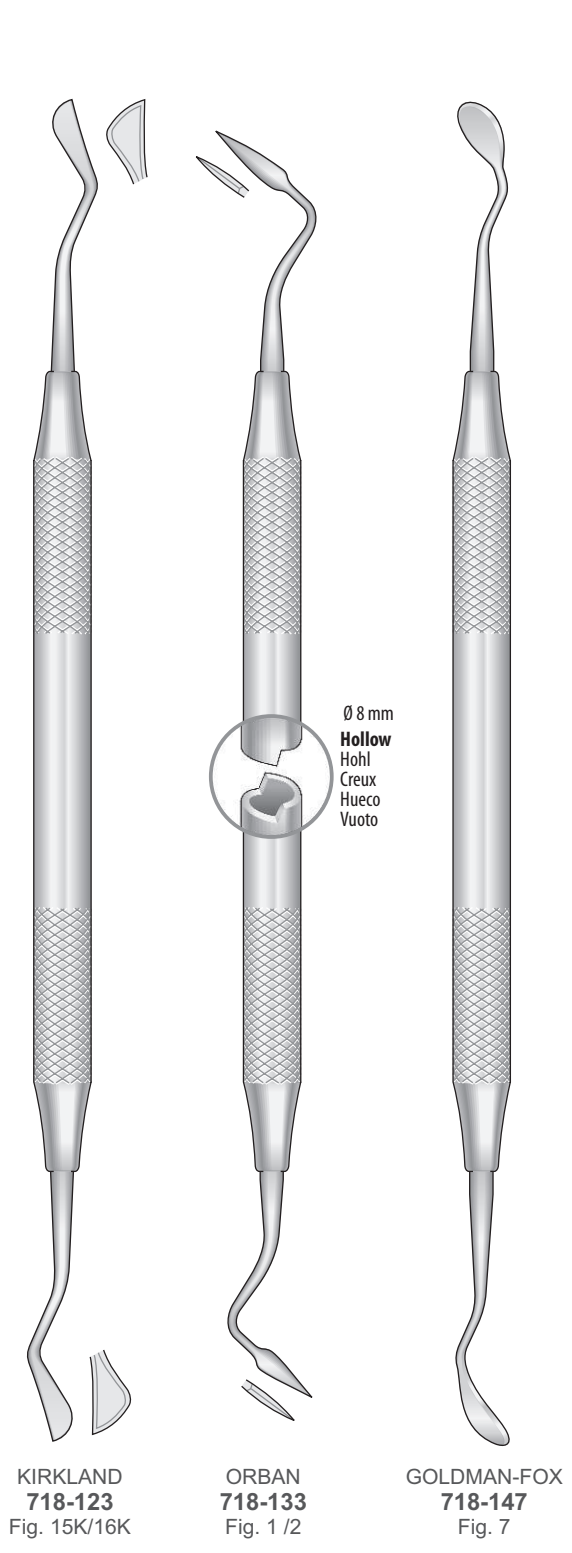

PERIO. ENDO
 & RESTORATION

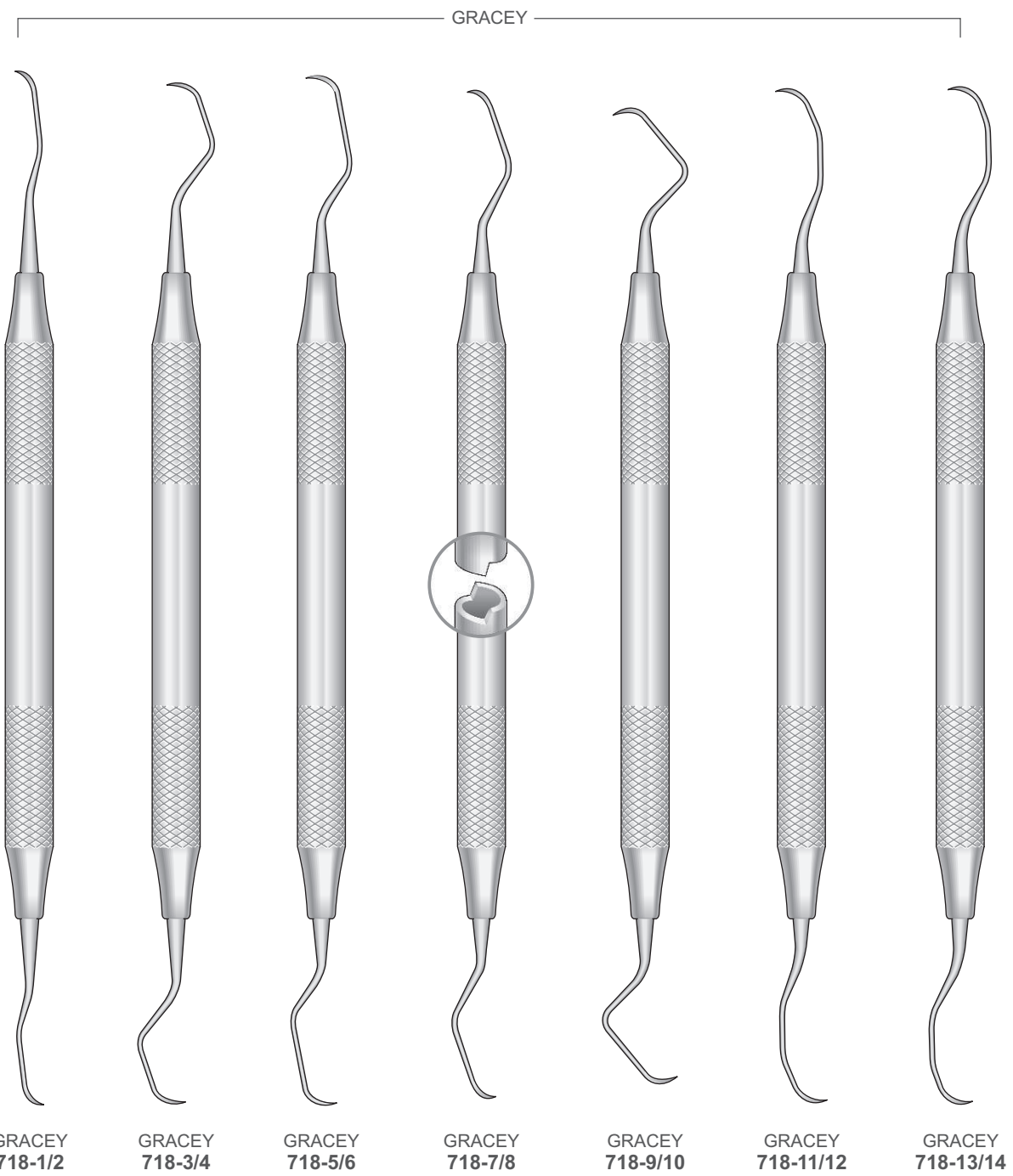

Küretten
Curettes
Curette
Curetas
Curettes

Mesial - Distal

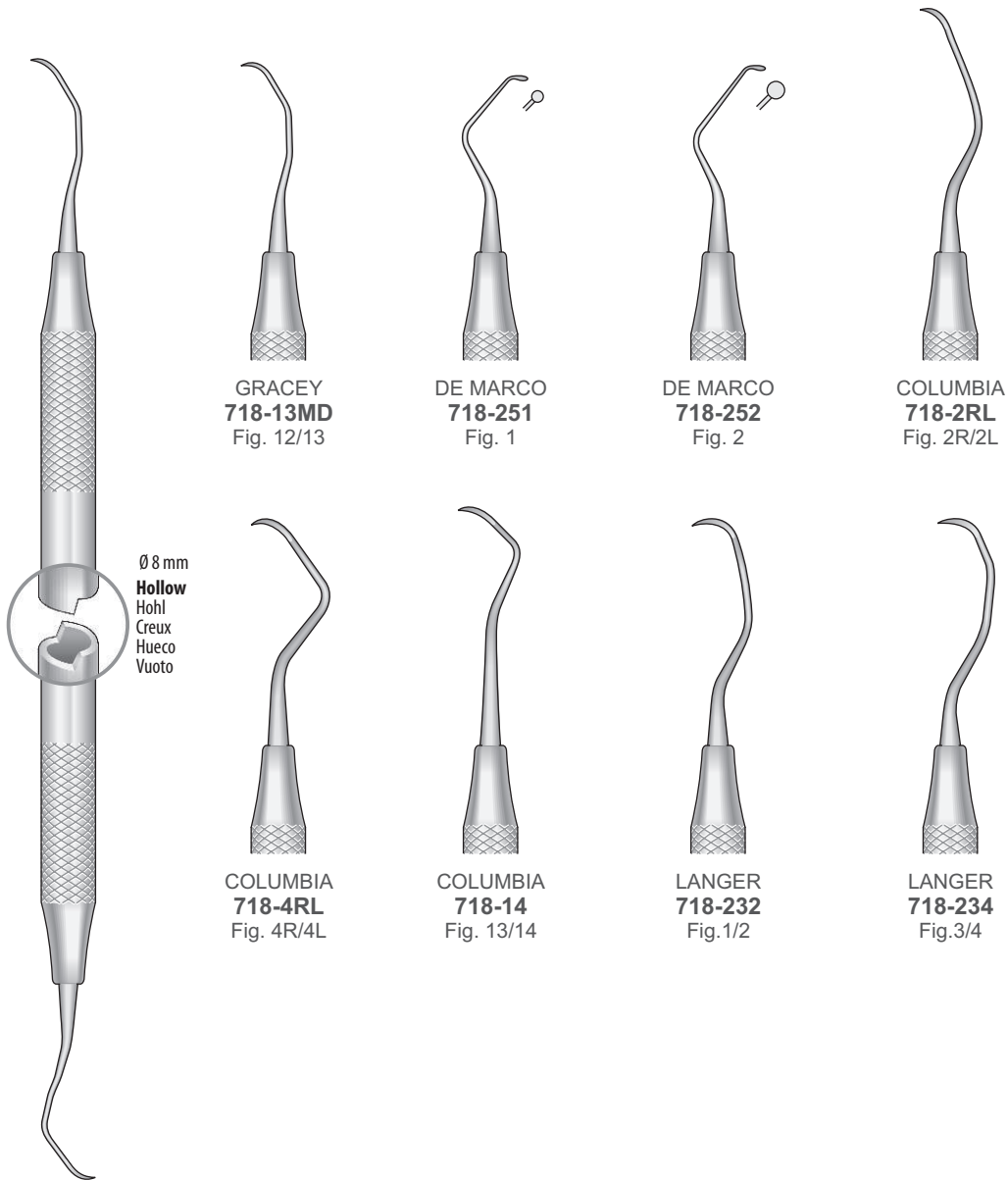

Ø 8 mm
Hollow
Hohl
Creux
Hueco
Vuoto

GRACEY
718-11MD
Fig. 11/14

PERIO. ENDO
& RESTORATION

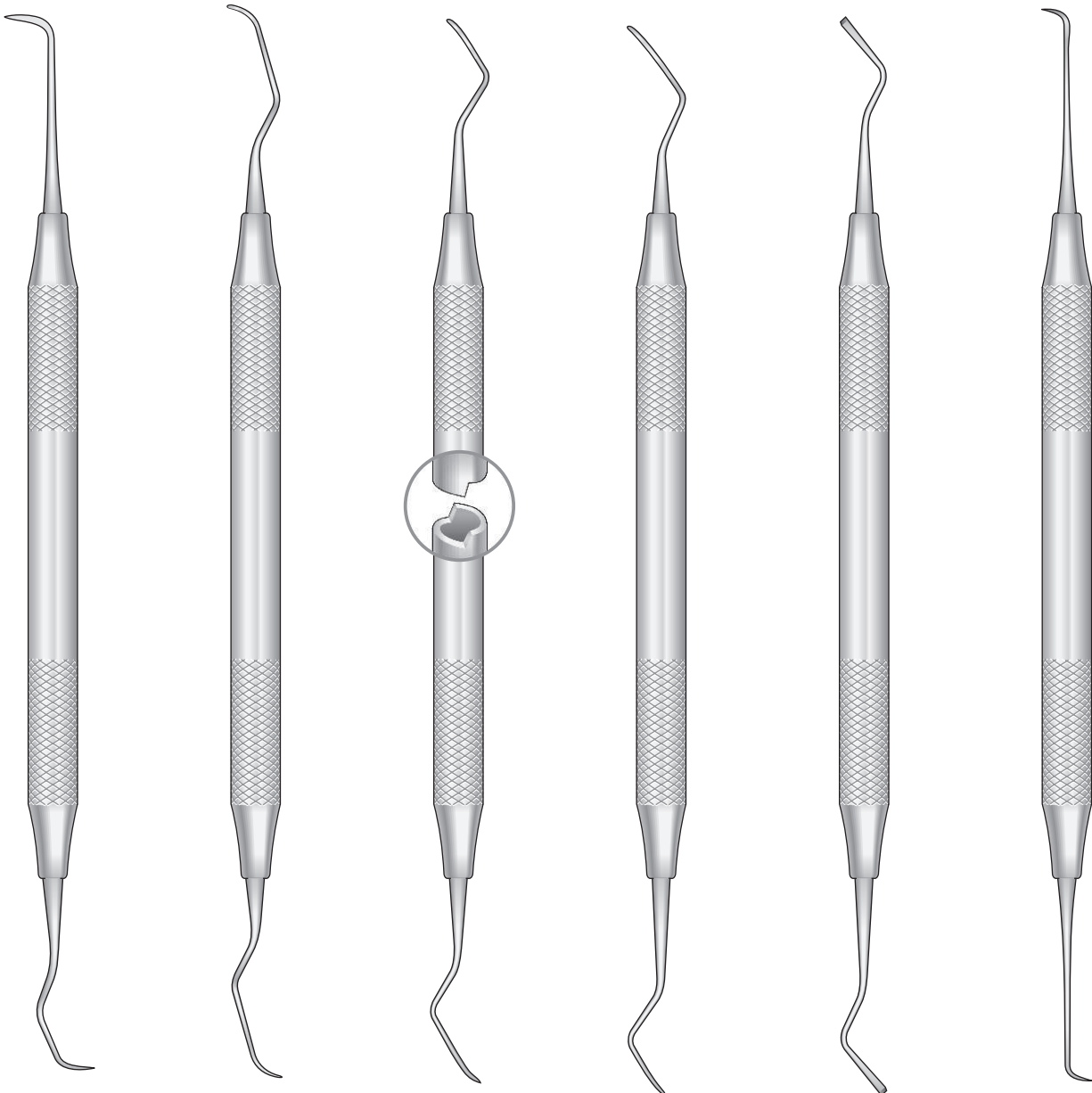

**GOLDMAN-FOX
718-271**
Fig. 1

**GOLDMAN-FOX
718-272**
Fig. 2

**GOLDMAN-FOX
718-273**
Fig. 3

**GOLDMAN-FOX
718-274**
Fig. 4

**GOLDMAN-FOX
718-275**
Fig. 5

**GOLDMAN-FOX
718-277**
Fig. 21



Ø 8 mm
Hollow
 Hohl
 Creux
 Hueco
 Vuoto

MC CALL
718-282
 Fig. 11/12



MC CALL
718-282A
 Fig. 11A/12A



MC CALL
718-284
 Fig. 13/14

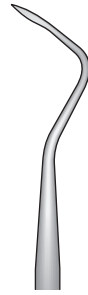

MC CALL
718-284S
 Fig. 13S/14S



MC CALL
718-288S
 Fig. 17S/18S



JAQUETTE
718-333
 Fig. 30/33



JAQUETTE
718-332
 Fig. 31/32



JAQUETTE
718-335
 Fig. 34/35



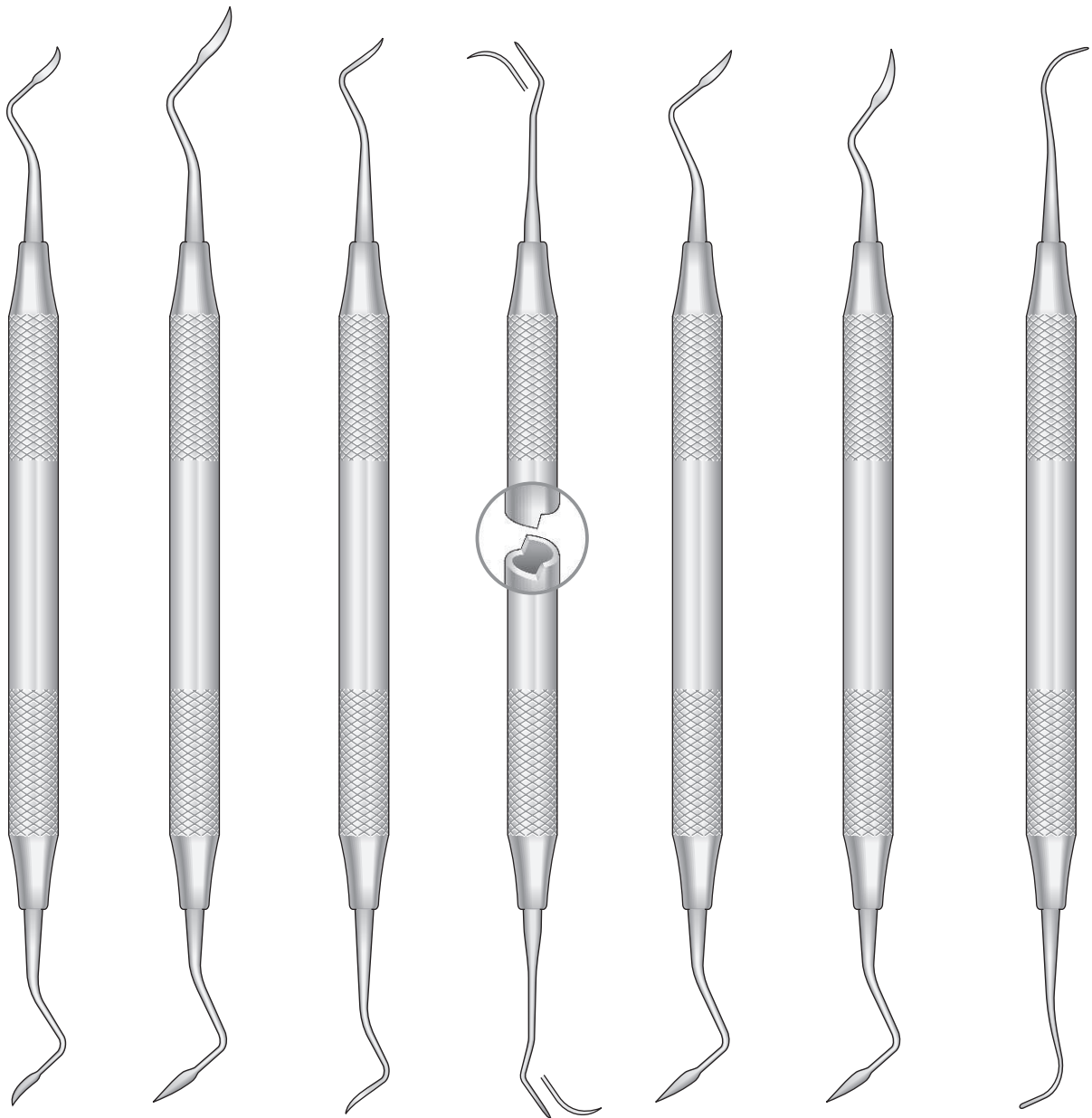

TAYLOR
718-TO3
Fig. 2/3

718-204
Fig. 204

718-204S
Fig. 204S

718-204SD
Fig. 204SD

718-CIO3
Fig. 2/3

CRANE-CAPLAN
718-CK6
Fig. 6

YOUNGER-GOOD
718-YGO8
Fig. 7/8



RULE 23/24
718-RO4
 Fig. 3 /4



I. UNIVERSITY
718-268
 Fig. 17/18



Ø 8 mm
Hollow
 Hohl
 Creux
 Hueco
 Vuoto

TOWNER-JAQUETTE
719-111
 Fig. U15/33



TOWNER-JAQUETTE
719-125
 Fig. H5/33



TOWNER-JAQUETTE
719-126
 Fig. H6/H7

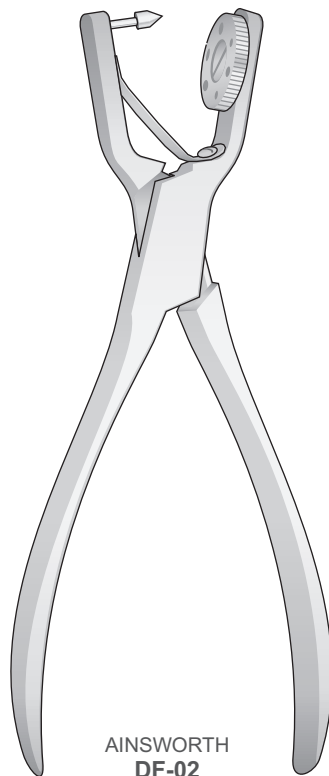

AINSWORTH
DF-02
 160 mm

Lochzangen
 Punch Forceps
 Pinze foradiga
 Perforadores
 Pincés à perforer

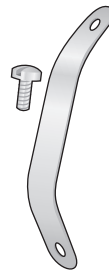

DF-02M
 Feder mit Schraube
 Spring with screw
 Molla con vite
 Muelle con tornillo
 Ressort avec vis



DF-02R
 Lochscheibe
 Punch Disk
 Disco divisore
 Disco agujereado
 Disque perforé



DF-02P
 Stift, mit Schraube
 Pin, with screw
 Perno con vite
 Punzòn con perno
 Broche

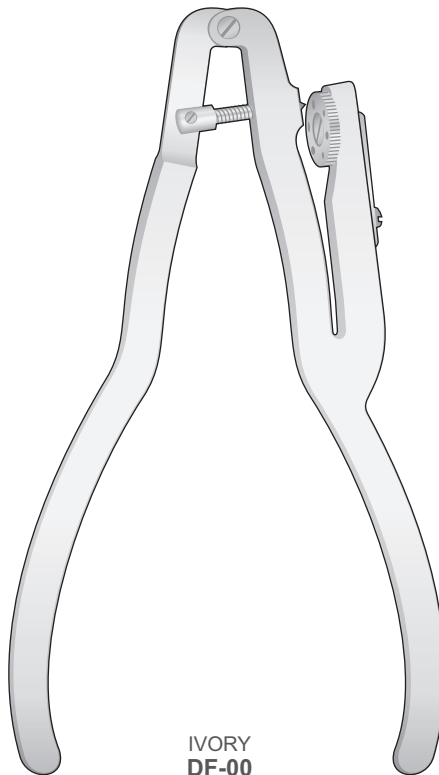

IVORY
DF-00
 160 mm

Lochzangen
 Punch Forceps
 Pinze foradiga
 Perforadores
 Pincés à perforer



DF-00M
 Spiralfeder
 Spiral Spring
 Molla a spirale
 Muelle espiral
 Ressort en spirale



DF-00L + DF-00V
 Feder mit Schraube
 Spring with screw
 Molla con vite
 Muelle con tornillo
 Ressort avec vis



DF-00R
 Lochscheibe
 Punch Disk
 Disco divisore
 Disco agujereado
 Disque perforé



DF-00P + DF-00N
 Stift, mit Schraube
 Pin, with screw
 Perno con vite
 Punzòn con perno
 Broche avec vis

Kofferdam-Klammerzangen
Rubber-Dam Clamp Forceps
Pinze per uncini
Pinzas para grapas dique de goma
Pinces porte-crampons

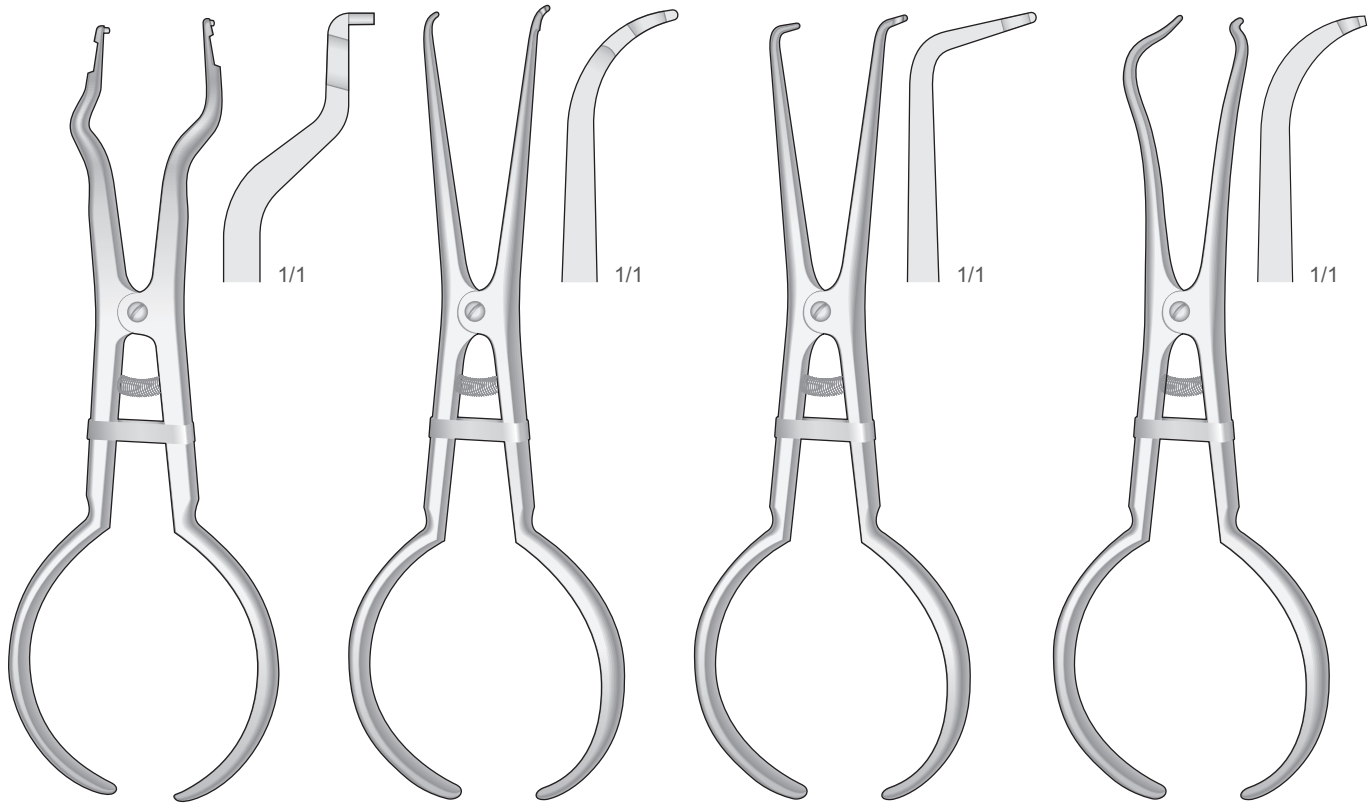

BREWER
DF-10
170 mm

PALMER
DF-15
170 mm

STOKE
DF-16
170 mm

DF-18
170 mm

PERIO. ENDO
& RESTORATION

Molaren, 12 Stück
 Molars, 12 pieces
 Molari, 12 pezzi
 Molares, 12 piezas
 Molaire, 12 Pièces

Premolaren, 12 Stück
 Premolars, 12 pieces
 Premolari, 12 pezzi
 Premolares, 12 piezas
 Prémolaires, 12 Pièces



DF-40/1
 Fig.1



DF-41/4
 Fig.4



DF-40/2
 Fig.2



DF-41/5
 Fig.5



DF-40/3
 Fig.3



DF-41/6
 Fig.6

Kofferdam-Klammerzangen
 Rubber-Dam Clamp Forceps
 Pinze per uncini
 Pinzas para grapas dique de goma
 Pincas porte-crampons

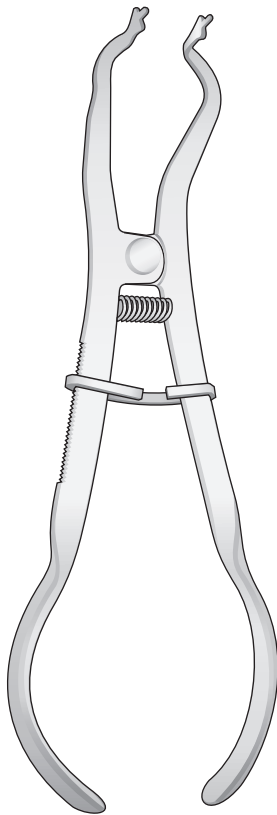

IVORY
DF-12
 170 mm

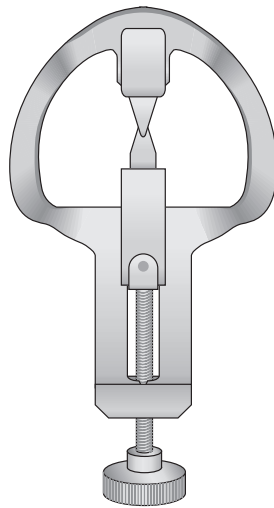

IVORY
DF-43
 Fig. 14

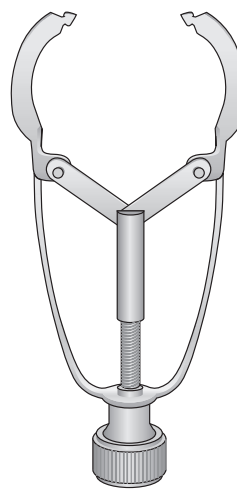

IVORY
DF-40
 Fig. 1

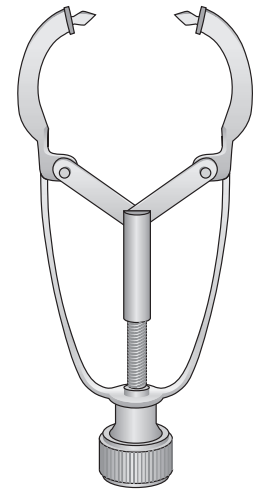

IVORY
DF-41
 Fig. 12

Kofferdam Instrumente
 Rubber-Dam Instruments
 Strumenti per diga
 Instrumentos para dique de goma
 Instruments pour digue de caoutchouc

Kofferdam-Klammern
 Rubber-Dam Clamps
 Uncini per diga
 Clamps para diques
 Crampons pour digue



IVORY
DF-126
 # 26



IVORY
DF-127
 # 27



IVORY
DF-128
 # 28



IVORY
DF-129
 # 29



IVORY
DF-130
 # 30



IVORY
DF-131
 # 31



IVORY
DF-151
 # 51



IVORY
DF-160
 # 60

Kofferdam-Rahmen
 Rubber-Dam Frames
 Telaio per diga
 Cuadro para diques
 Cadre à digue



Stainless Steel
 Rostfreier Stahl
 Acier inoxydable
 Acero inoxidable
 Acciaio inossidabile

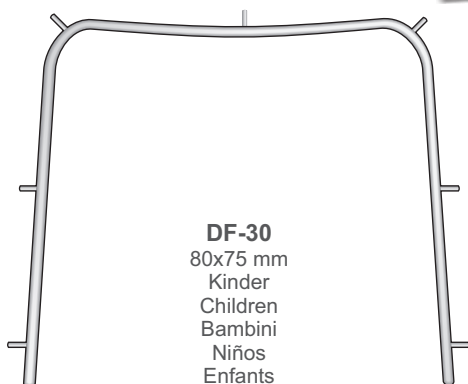

DF-30
 80x75 mm
 Kinder
 Children
 Bambini
 Niños
 Enfants

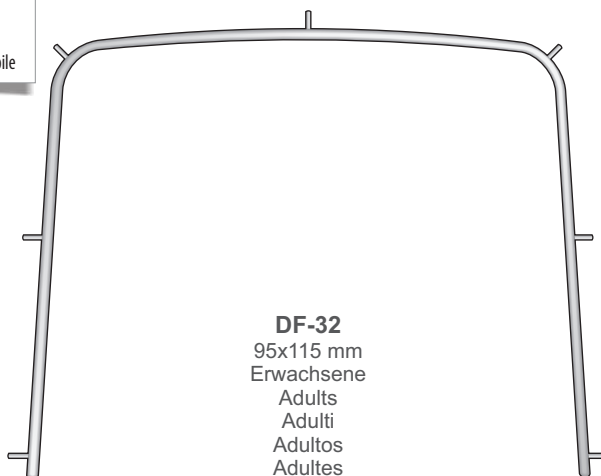

DF-32
 95x115 mm
 Erwachsene
 Adults
 Adulti
 Adultos
 Adultes

PERIO. ENDO
 & RESTORATION

Molaren, 12 Stück
 Molars, 12 pieces
 Molari, 12 pezzi
 Molares, 12 piezas
 Molaires, 12 Pièces

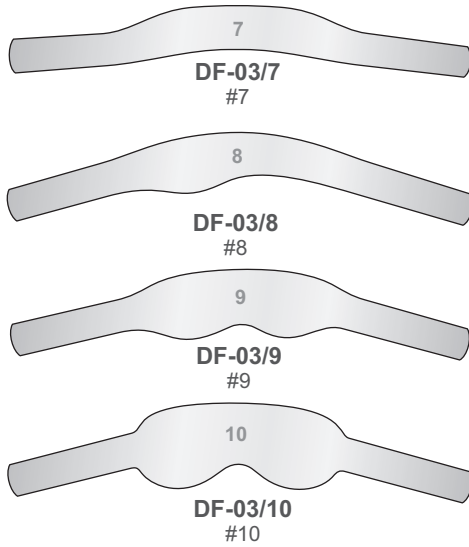

Premolaren, 12 Stück
 Premolars, 12 pieces
 Premolari, 12 pezzi
 Premolares, 12 piezas
 Prémolaires, 12 Pièces

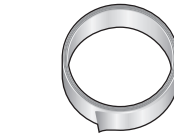
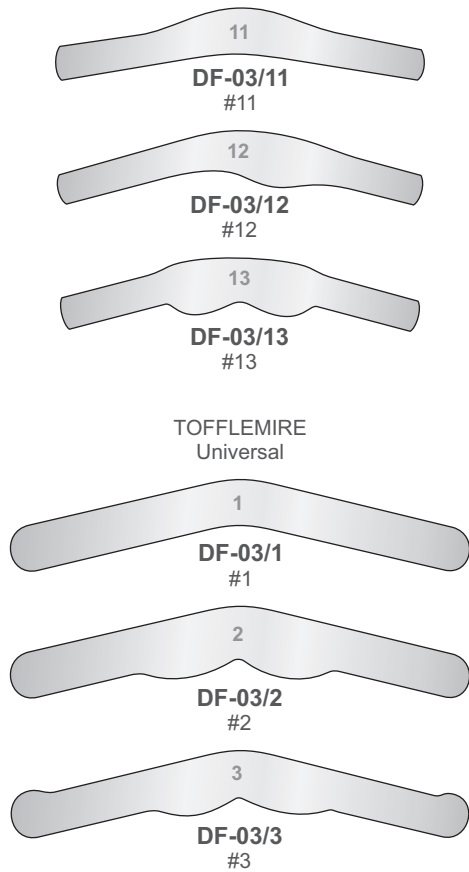

DF-01/5 5 mm x 1 mt
DF-01/6 6 mm x 1 mt
DF-01/7 7 mm x 1 mt



DF-05/5 5 mm x 5 mt
DF-05/6 6 mm x 5 mt
DF-05/7 7 mm x 5 mt

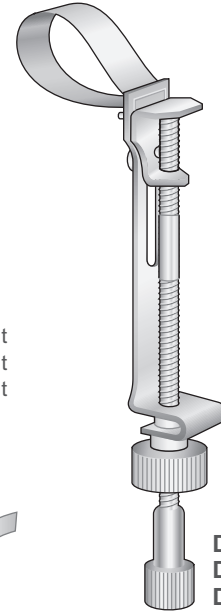

DF-06 5 mm
DF-08 6 mm
DF-09 7 mm

IVORY
DF-06/DF-09
 #8

Paar - Pair
 Coppia - Par
 Paire

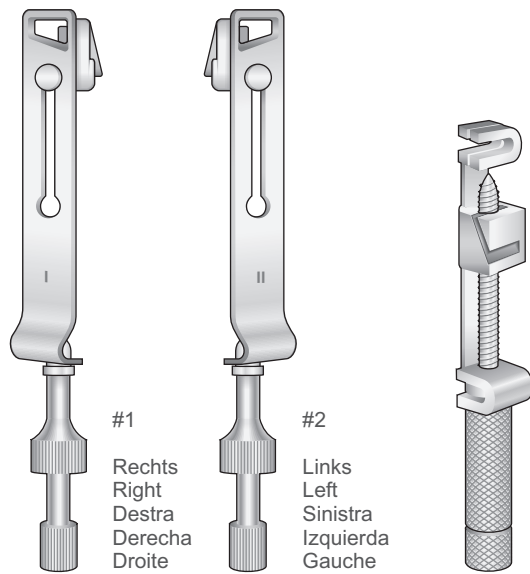

#1
 Rechts
 Right
 Destra
 Derecha
 Droite

#2
 Links
 Left
 Sinistra
 Izquierda
 Gauche

NYSTRÖM
DF-04
 #1 + #2

TOFFLEMIRE
DF-07
 Universal

• Crown and Bridge

315 | Crown and Bridge Instruments



CROWN
& BRIDGE

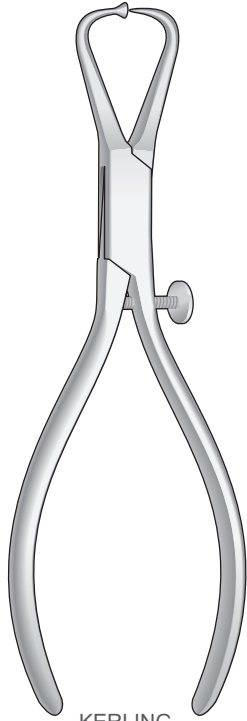

**KERLING
 DP-38A**
 145 mm

Kupferingabnehmzange
 Copper Ring Removing Pliers
 Pinza per togliere anelli di rame
 Pinza para sacar anillos de cobre
 Pince à enlever les bagues en cuivre

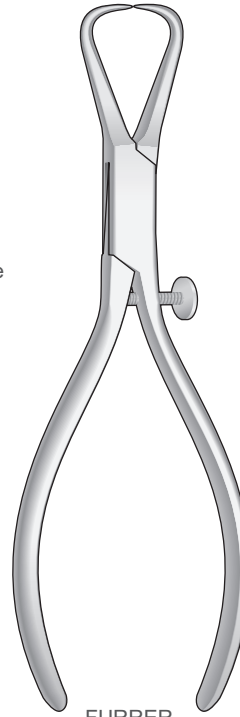

**FURRER
 DP-38**
 145 mm

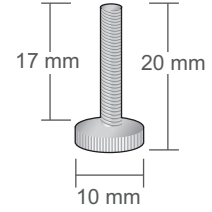

DP-38R
 Schraube
 Replacement Screw
 Vite di ricambio
 Tornillos de recambio
 Vis de rechange

Teleskopkronenzangen - Pliers for telescope crowns
 Pinze per corone telescopiche - Alicates para coronas telescópicas
 Pincès pour couronnes telescopes

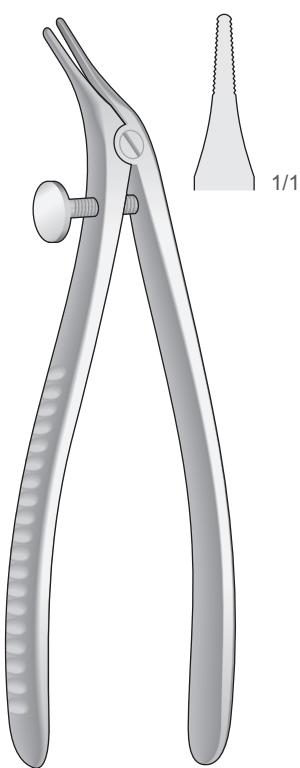

**BÖHM
 DP-28**
 150 mm

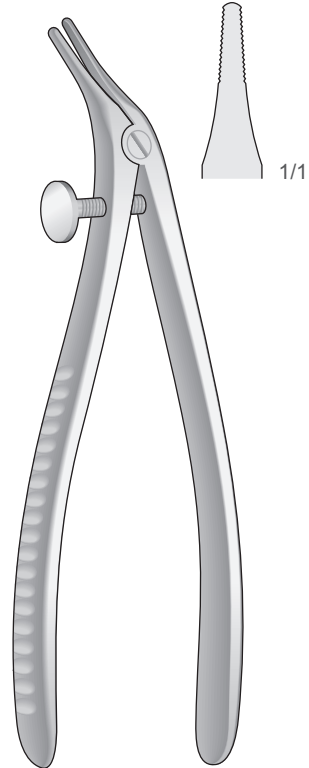

**BÖHM
 DP-29**
 150 mm

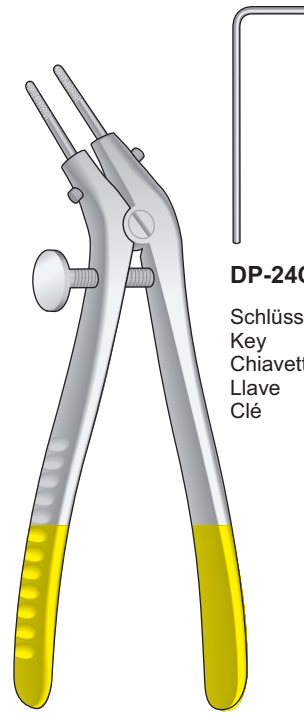

DP-24
 120 mm



DP-24C
 Schlüssel
 Key
 Chiavetta
 Llave
 Clé



DP-24R
 Diamantierte Einsätze, paar
 Diamond inserts, pairs
 Punte diamantate, coppia
 Puntas diamantadas, par
 Pointes diamantées, pair

MRT-C7
 Complete Bridge Extractor
 MRT-7 + C-71 + C-72 + C-73 + C-74

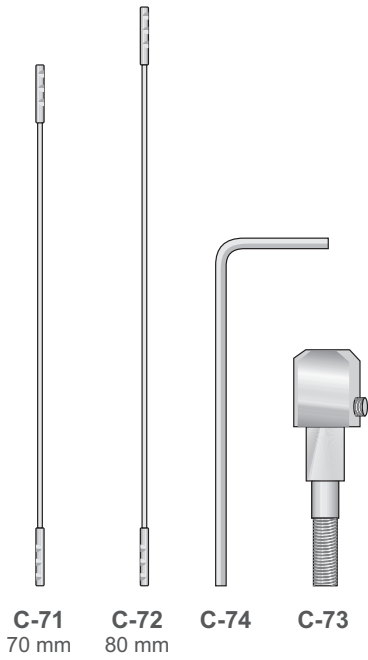

Removing pliers
 for temporary
 bridges and crowns

TC
Tungsten-Carbide Inserts
 Mit Hartmetalleinsätzen
 Plaquettes en carbure de tungstène
 Plaquetas de carburo de tungsteno
 Inserti in carburo di tungsteno

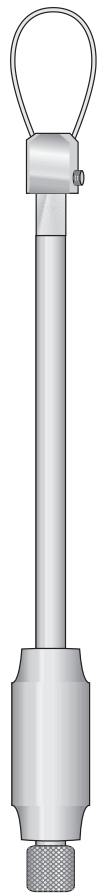

MRT/C7

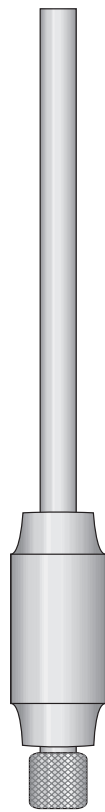

MRT-7

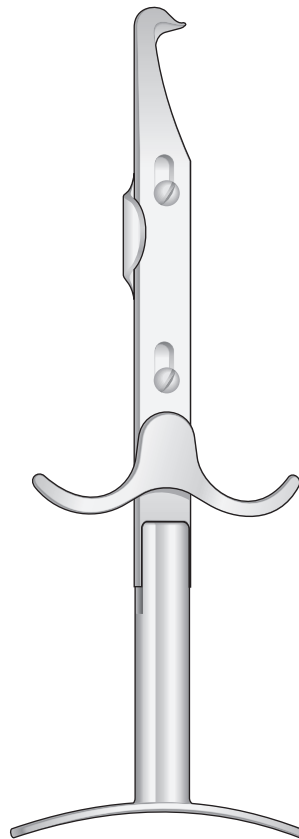

MRT-6
170 mm

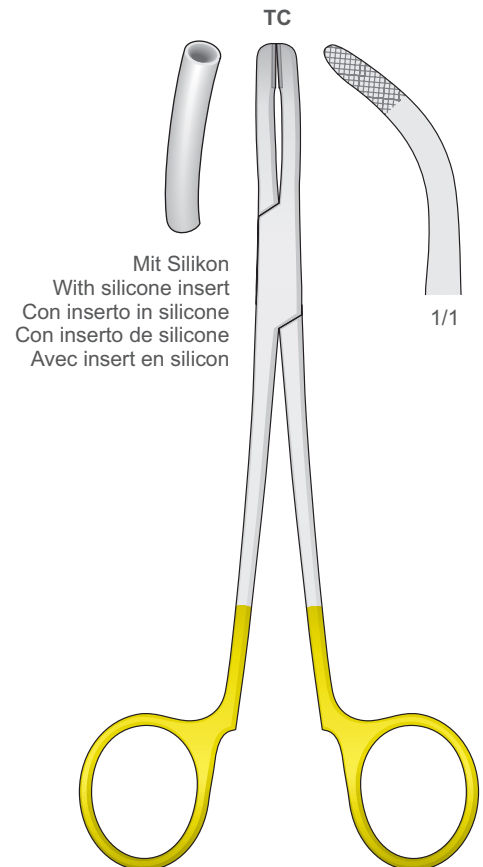

PH-60
170 mm

Kronenentferner
 Crown Removers
 Leva corone
 Removedor de coronas
 Enlève-couronne

MRT-C3
 Complete with 3 Attachments
 C-34 + C-35 + C-36

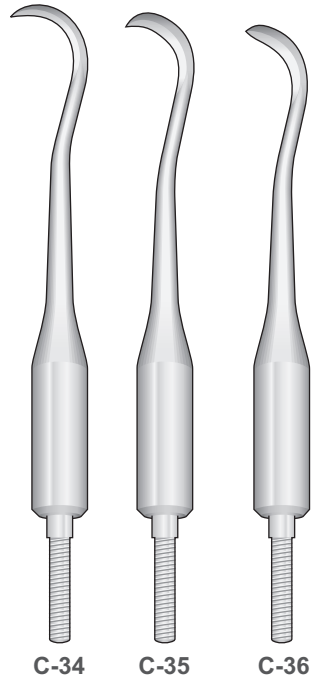

MRT-C4
 Complete with 3 Attachments
 C-41 + C-42 + C-43

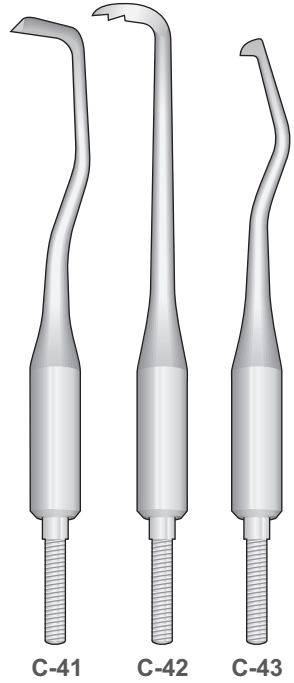

MRT-C1
 Complete with 3 Attachments
 C-11 + C-12 + C-13

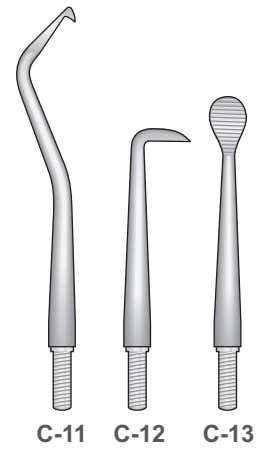

C-30

Usando la punta C-30
 e invertendo la molla
 si usa come spingicorone

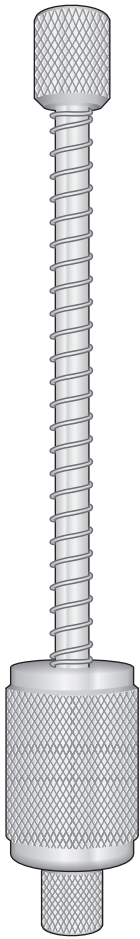

MRT-C3



MRT-C4



MRT-C1

CROWN
 & BRIDGE

Kronentferner
 Crown Removers
 Leva corone
 Removedor de coronas
 Enlève-couronne

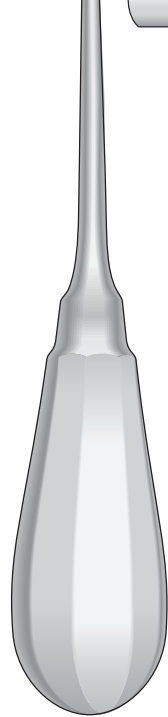
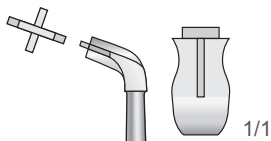

UNIVERSAL
DL-60
 150 mm



DL-C
 140 mm



DL-V
 130 mm



DL-0
 130 mm

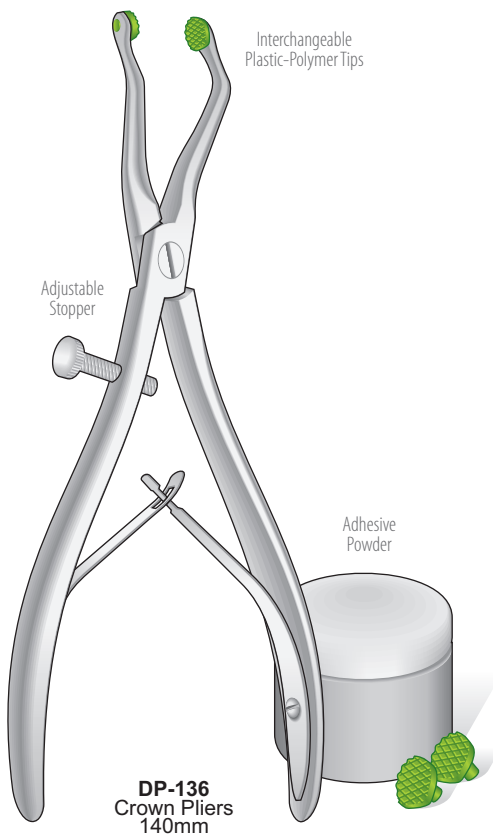

DP-136
 Crown Pliers
 140mm

TEMPORARY CROWN PLACEMENT KIT | DP-136
 1 Crown Pliers + 20 Replacement Tips + 10g Adhesive Powder

Crown Pliers: designed to remove upper and lower crowns and bridges. An adjustable stopper allows to adjust the grasping tips to the width of the crown and locking into place. It will prevent any unwanted pressures to the crown avoiding potential damages. The double spring back action along with the hook-lock mechanism allows for a smooth grasping motion.

Polymer Plastic Replacement Tips: provide a perfect and safely grip for temporary ceramic crowns without damaging metal, resin, or ceramic surfaces. A better grip of the crown can be achieved if the tips are coated with the supplied adhesive powder which is dampened by saliva.

Adhesive Powder: denture adhesive used as "glue" for recementing crowns or bridges that have come off.

DP-137 / Replacement Kit for DP-136: 20 Replacement Tips + 10g Adhesive Powder

Useful Data & Maintenance

321 | Conversion of Units

**322 | Cleaning, Maintenance
& Sterilization**

**323 | Maintenance Cycle
& Tips**



Umrechnung von Einheiten | Conversion des unités | Conversión de unidades | Conversione delle unità

Temperature / Celsius • Fahrenheit

°C	-18	-10	0	10	20	30	40	50	60	70	80	90	100	110	120	130	140	150	200	250	300	350
°F	0	14	32	50	68	86	104	122	140	158	176	194	212	230	248	266	284	302	392	482	572	662

Length / International System (SI) • English system (Imperial)			French Gauge System		American Wire Gauge			Standard Wire Gauge		
SI	SI	Imperial	in	mm	Charrière	Ø mm	Ø in	SWG	Ø mm	Ø in
1 mm	-	0.0394 in	0.001	0.0254	1	0.33	0.012	7/0	0.500	12.700
1 cm	10 mm	0.3937 in	0.002	0.0508	2	0.67	0.028	6/0	0.464	11.786
1 m	1000 mm	1.0936 yd	0.003	0.0762	3	1.00	0.039	5/0	0.432	10.973
Imperial	Imperial	SI	0.004	0.1016	4	1.33	0.051	4/0	0.400	10.160
1 in	-	2.540 cm	0.005	0.1270	5	1.67	0.067	3/0	0.372	9.449
1 ft	12 in	30.48 cm	0.006	0.1524	6	2.00	0.079	2/0	0.348	8.839
1 yd	3 ft	91.440 cm	0.007	0.1778	7	2.33	0.091	0	0.324	8.230
			0.008	0.2032	8	2.67	0.106	1	0.300	7.620
			0.009	0.2286	9	3.00	0.118	2	0.276	7.010
in (frac.)	in (decimal)	mm	0.010	0.2540	10	3.33	0.130	3	0.252	6.401
1/64	0.0156	0.3969	0.011	0.2794	11	3.67	0.146	4	0.232	5.893
1/32	0.0313	0.7938	0.012	0.3048	12	4.00	0.157	5	0.212	5.385
1/16	0.0625	1.5875	0.013	0.3302	13	4.33	0.169	6	0.192	4.877
1/8	0.1250	3.1750	0.014	0.3556	14	4.67	0.185	7	0.176	4.470
3/16	0.1875	4.7625	0.015	0.3810	15	5.00	0.197	8	0.160	4.064
1/4	0.2500	6.3500	0.016	0.4064	16	5.33	0.209	9	0.144	3.658
5/16	0.3125	7.9375	0.017	0.4318	17	5.67	0.224	10	0.128	3.251
3/8	0.3750	9.5250	0.018	0.4572	18	6.00	0.236	11	0.116	2.946
7/16	0.4375	11.1125	0.019	0.4826	19	6.33	0.248	12	0.104	2.642
1/2	0.5000	12.7000	0.020	0.5080	20	6.67	0.264	13	0.092	2.337
9/16	0.5625	14.2875	0.021	0.5334	21	7.00	0.276	14	0.080	2.032
5/8	0.6250	15.8750	0.022	0.5588	22	7.33	0.287	15	0.072	1.829
11/16	0.6875	17.4625	0.023	0.5842	23	7.67	0.303	16	0.064	1.626
3/4	0.7500	19.0500	0.024	0.6069	24	8.00	0.315	17	0.056	1.422
13/16	0.8125	20.6375	0.025	0.6350	25	8.33	0.327	18	0.048	1.219
7/8	0.8750	22.2250	0.026	0.6604	26	8.67	0.343	19	0.040	1.016
15/16	0.9375	23.8125	0.027	0.6858	27	9.00	0.354	20	0.036	0.914
1	1.0000	25.4000	0.028	0.7112	28	9.33	0.366	21	0.032	0.813
			0.029	0.7366	29	9.67	0.382	22	0.028	0.711
			0.030	0.7620	30	10.00	0.394	23	0.024	0.610
			0.031	0.7874	31	10.33	0.406	24	0.022	0.559
			0.032	0.8128	32	10.67	0.421	25	0.020	0.508
			0.033	0.8382	33	11.00	0.433	26	0.018	0.457
			0.034	0.8636	34	11.33	0.445	27	0.016	0.417
			0.035	0.8890	35	11.67	0.461	28	0.015	0.376
			0.036	0.9144	36	12.00	0.472	29	0.014	0.345
			0.037	0.9398	37	12.33	0.484	30	0.012	0.315
			0.038	0.9652	38	12.67	0.500	31	0.012	0.295
			0.039	0.9906	39	13.00	0.512	32	0.011	0.274
			0.0394	1.0000	40	13.33	0.524	33	0.010	0.254
					41			34	0.009	0.234
					42			35	0.008	0.213
								36	0.008	0.193
								37	0.007	0.173
								38	0.006	0.152
								39	0.005	0.132

Volume / Milliliters • Fluid Ounces • Cubic Centimeters					
mL	US oz	US oz	UK oz	UK oz	cc (cm ³)
1.0	1/32	0.033814	0.035195	1/32	1.0
29.574	1	1.0	13/64	1.0409	29.574

in	cm	mm	in
1	2.54	1	0.0394
2	5.08	2	0.0787
3	7.62	3	0.1181
4	10.16	4	0.1575
5	12.7	5	0.1969
6	15.24	6	0.2362
7	17.78	7	0.2756
8	20.32	8	0.3150
9	22.86	9	0.3543
10	25.40	10	0.3937
11	27.94	11	0.4331
12	30.48	12	0.4724
13	33.02	13	0.5118
14	35.56	14	0.5512
15	38.10	15	0.5906
16	40.64	16	0.6299
17	43.18	17	0.0669

Cleaning, Maintenance & Sterilization

Sharpen • Lubricate



Arkansas # 4
100 x 25 x 12 mm
4 x 1 x 0.5 in

DB-4

Rectangular Stone

A flat and rectangular stone used to sharpen all cutting parts of surgical instruments. Necessary in routine sharpening and finishing of edge and toe of an instrument.



Arkansas # 8
100 x 50 x 13 mm
4 x 2 x 0.5 in

DB-96

Flat Stone

A flat and rectangular stone used to sharpen all cutting parts of scissors, osteotomes, curettes, etc. (whenever necessary).



Arkansas # 299
Ø 8 x 90 mm
Ø 0.3 x 3.5 in

DB-299

Conical Stone

A cone-shaped and cylindrical stone used to manually sharpen internal parts of curettes, scalars, gouges, rongeurs, etc. (in areas that otherwise cannot be reached).



India # 6
100 x 45 mm
4 x 1.8 in
Medium grit

DB-3

DB-6A

Wedge Stones

They combine flat surfaces with rounded edges to manually sharpen internal parts (straight and curved edges) of curettes and scalars.

Arkansas: for routine sharpening and finishing.

India: for sharpening of excessively dull instruments or those requiring recontouring.

• *Arkansas:* a natural stone extracted from the Arkansas mountains. • *India:* a synthetic stone quarried from the finest Ozark novaculite - silicon quartz- deposits.



Ceramic Stone

Ceramic stones (autoclavable) are valued for their durability and the very keen edge they give in the finer grits. Will never pit or groove. Used for routine sharpening procedures.

Use only dry
(do not use with oil, water or lubricants)

DB-71

76 x 25 x 6 mm / 3 x 1 x 1/4 in



Plastic Stick for sharpening test

A hard plastic stick used to test the blade of an instrument to determine the sharpness of an instrument. Must be used ALWAYS.

If the blade of the instrument runs smoothly over the plastic stick, then it is blunt. A sharp instrument will grab into the stick and removes small fragments of the plastic.

DB-15

Ø 7 x 75 mm / Ø 0.28 x 3 in



Lubricating & Sharpening Oil for surgical instruments

A non-coloured oil, which is an indispensable complement for lubricating and manual sharpening of surgical instruments. To activate the abrasive properties of Arkansas or India stones and to reduce the possibility of overheating the instruments during sharpening. It should be applied on all hinges or all other parts which are subject to movement or friction. Its use facilitates elimination of any residue present within the instrument hinges. Used to ensure perfect function and fluid movement of all surgical instruments.

Must ALWAYS be used during all sharpening operations.

DB-OL

30 cc / 1 fl oz

Rinse • clean



CLEANLACT | Detergent Milk

Concentrated milk. Bacteriostatic detergent, rust inhibitor and lubricating action on all surgical instruments. It guarantees perfect maintenance by eliminating eventual stains, halos and browning due to sterilization, disinfection and washing with tap water.

Must be applied periodically, diluted or concentrated to extends your instrument's lifetime (view special instructions on packaging).

DB-1L

1000 cc
34 fl oz

DB-50M

500 cc
17 fl oz

DB-10M

250 cc
8.5 fl oz



Cleaning Brushes

Special brushes (autoclavable) to clean surgical instruments. Used to remove eventual residue, organic or not, from all surgical instruments, in particular in angled, hinged and knurled parts, without damaging instrument surface.

Must be applied every time, for regular cleaning of all instrumentation and in the event that an instrument is exposed for an extended period to air before being immersed in the cleaning solution.

DB-11

155 mm
6 in



Anti-Stain Rubber for metal

An abrasive eraser specially designed for surgical instruments to remove stains, halos or persistent burnishing from all surgical instruments without damaging the instrument surface.

Necessary when routine cleaning does not remove all stains.

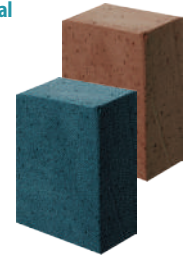

DB-08

50 x 40 x 20 mm / 2 x 1.6 x 0.8 in
Coarse

DB-07

2 x 1.6 x 0.8 in
Fine

Sterilization Cassettes • Stainless steel trays with silicone racks

Coding

Silicone Code Rings



DB-941

120 Items

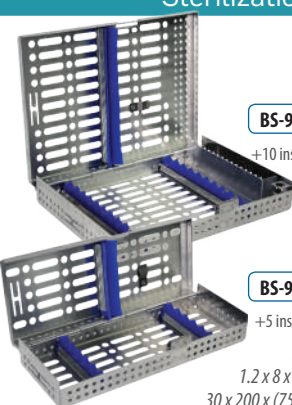

BS-910^B

+10 instrum.

BS-920^D

+20 instrum.

BS-905^A

+5 instrum.

BS-915^C

+15 instrum.

Autoclavable

1.2 x 8 x (3^A)(6^B)(11^C)(12^D) in
30 x 200 x (75^A)(150^B)(275^C)(300^D) mm

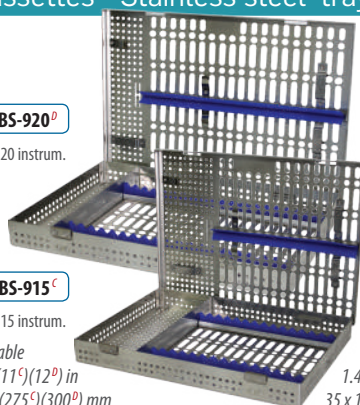

BS-59^E

+5 instrum.

BS-60^F

+10 instrum.

BS-61^G

+20 instrum.

Autoclavable

1.4 x 7 x (3^F)(5.7^G)(11.5^H) in
35 x 185 x (75^F)(145^G)(290^H) mm

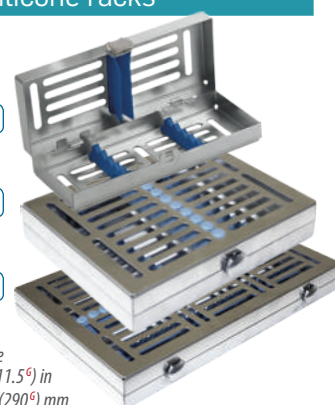

Cassettes BS-Series: available only in North America

MAINTENANCE

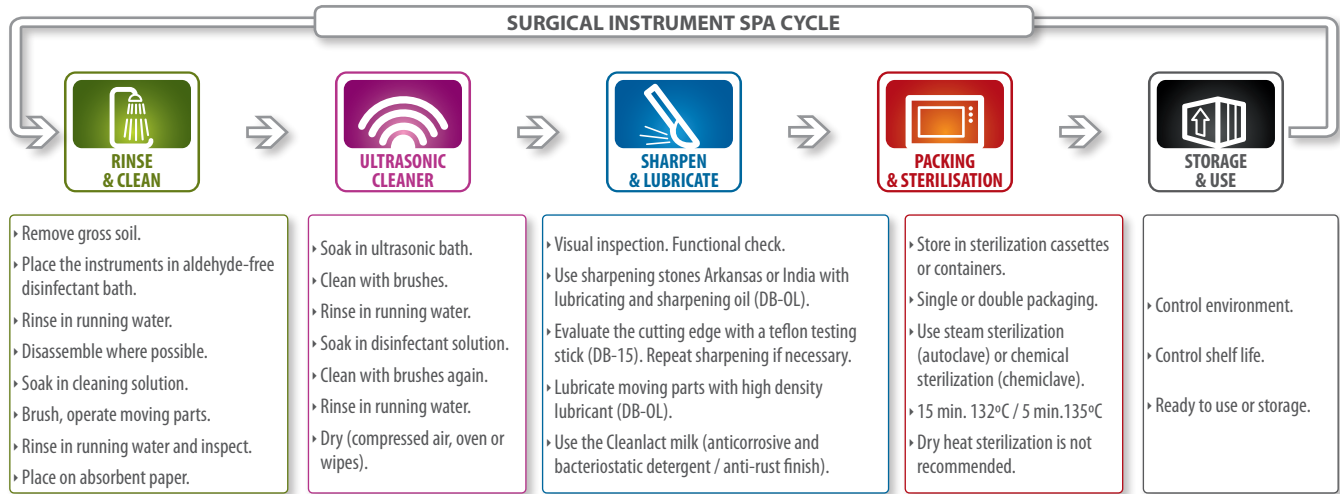

RINSE AND CLEAN

Immediately after surgery, rinse instruments under warm running water (not hot). Use only neutral detergent (pH=7).

ALWAYS SHARPEN YOUR INSTRUMENTS

Why? Surgical Instruments should be kept identical to their original design. Surgical procedures are most effective when using sharp instruments as they reduce hand and wrist fatigue, improve calculus removal, save time, improve tactile sensitivity, and minimize patient discomfort.

When? Instruments should be sharpened lightly after each use; there are two ways to evaluate whether the cutting edge is dull and requires sharpening:

- Visual:** The cutting edge should be inspected regularly in a good light (and if possible, under magnification). If the cutting edge is blunt it will be rounded and reflect the light. A dull, non-reflective line indicates sharpness.
- Teflon Test Stick (DB-15):** If the blade of the instrument runs smoothly over the testing stick, then it is blunt. A sharp instrument will grab into the stick and removes small fragments of the plastic.

How? The instruments should be sharpened following this procedure:

- Place one drop of sharpening oil (DB-OL) on the Arkansas sharpening stone. Lubrication improves the movement of the instrument blade over the stone; also, it prevents the metal particles from clogging the stone.
- Hold the instrument in one hand, while applying the stone to the lateral surface angled with the face of the blade.
- Position the stone to contact the heel of the blade and work toward the tip, keeping the stone in contact with the blade throughout the sharpening procedure.
- Move the stone up and down with short strokes, placing more pressure on the down stroke (do not move the instrument, keep the instrument still).
- Always finish instrument sharpening with a down stroke; this will prevent a rough edge from forming and remove any flash of metal.
- Evaluate the sharpness with teflon test stick (DB-15). If the blade is still dull, re-evaluate the angle of the stone and repeat the sharpening (steps 2-6).

*Sharp, delicate and TC instruments
Scissors, needle holders or bone forceps should be cleaned manually by using cleaning brushes.*

*Lubrication
Regular use of DB-OL lubricant oil and "Cleanlact" detergent milk, will prevent rust, corrosion, and stiff joints.*

*TC instruments
Tungsten carbide instruments are more sensitive to chemicals and require special care. They should never be exposed to chemical substances or to any other corrosive chemicals.*

*Sharpening
Regular sharpening will enhance the life of your cutter and will improve the quality of your work.*

*Ultrasound cleaning
It is not recommended for scissors, needle holders, bone forceps and all tungsten carbide instruments.*

ULTRASONIC CLEANING

It is recommended for regular instruments such as hand instruments and extraction forceps, following this procedure:

- Sort instruments carefully so as to include only instruments compatible with ultrasonic cleaning. Do not combine different metals (stainless, copper, chrome plated, etc.).
- Place instruments in open position. Make certain sharp edges are not touching other instruments.
- Change solution frequently to avoid accumulation of micro organisms.
- After rinsing and before sterilization, inspect and dry the instruments thoroughly.

⚠ Ultrasonic cleaning does not sterilize. Do not use for TC instruments, sharp and delicate instruments.

SHARPENING OF SCALERS AND CURETTES

Sickle Scaler Toe End: the sickle scaler has a pointed tip and, therefore, the stone is held straight as it nears the tip.

Curette Toe End: the curette has a rounded toe, so the position of the stone is adapted around the rounded cross-section.

⚠ Always finish instrument sharpening with a down stroke; this will prevent a rough edge from forming and remove any flash of metal.

CARE OF SHARPENING STONES

After use, wipe the stone with a clean cloth to remove metal particles. Then, clean the stone by scrubbing or using ultrasound to remove lubricant before sterilization. After sterilization, lubricate with DB-OL before each use.

⚠ Be sure to use entire stone to prevent "grooving".

STERILIZATION

Autoclave (Steam Sterilization)

Time and temperature: 15 min. 132°C (270°F) / 5 min. 135°C (275°F)

Chemiclave (Chemical Sterilization)

Time and temperature: 15 min. 132°C (270°F) / 5 min. 135°C (275°F)

Dry Heat Sterilization (not recommended)

Time and temperature: 90 min. 160°C (320°F) / 60 min. 170°C (340°F)

⚠ Sterilization cannot substitute cleaning.

▪ Index

327 | Alphanumeric Codes

Alphanumeric Codes

CODE	PP.	ID	CODE	PP.	ID	CODE	PP.	ID	CODE	PP.	ID
7	3		712-122	293		718-3/4	302	GRACEY	720-103	232	HEMINGWAY
8	8		712-122L	293		718-4R	303	COLUMBIA	720-104	232	HEMINGWAY
13	6		712-123	293		718-5/6	302	GRACEY	720-111	239	WAHL
17	3		712-123L	293		718-7/8	302	GRACEY	720-112	239	WAHL
18	3		712-124	293		718-9/10	302	GRACEY	725-1/2	47	HEIDBRINK
21	8		712-124L	293		718-11MD	303	GRACEY	725-3/4	47	HEIDBRINK
22-1/2L	11		712-125L	293		718-11/12	302	GRACEY	725-3/4S	47	HEIDBRINK
22-1/2R	11		712-131	295		718-13MD	303	GRACEY	725-5/6	47	HEIDBRINK
22	6		712-132	295		718-13/14	302	GRACEY	A-1	275	
29	4		712-133	295		718-14	303	COLUMBIA	AL-MA5	257	
30	4		712-161H	294		718-24G	229		AM-1	24	
33	6		712-162H	294		718-103	286	OCHSENBEIN	AM-5	31	PHYSICK
33A	6		712-163H	294		718-104	286	OCHSENBEIN	AM-15	30	HARRIS
46L	12		712-164H	294		718-107	286	RHODES	AM-16	30	
48	12		712-171	295	WESTCOTT	718-113	286		AM-17	29	
49	12		712-172	295	WESTCOTT	718-123	301	KIRKLAND	AM-18L	27	HARRIS
51	5		712-182	295	LADMORE	718-133	301	ORBAN	AM-18R	27	HARRIS
51A	5		712-183	295	LADMORE	718-147	301	GOLDMAN-FOX	AM-23	29	
51L	5		712-191	296		718-148	301	GOLDMAN-FOX	AM-24	27	
55	10		712-192	296		718-149	301	GOLDMAN-FOX	AM-32	26	PARMLY
56	10		712-201	296		718-151	301	GOLDMAN-FOX	AM-32A	26	PARMLY
67A	5		712-202	296		718-154	301	BUCK	AM-53L	25	
68	10		712-221	296		718-156	301	BUCK	AM-53R	25	
68A	10		712-222	296		718-162	301	SANDERS	AM-62	24	
73	6		712-223	296		718-165	301	SANDERS	AM-65	26	
74	7		712-231	296		718-170	301	USC TOWNER	AM-69	28	TOMES
74N	7		712-232	296		718-191	228	HOPKINS	AM-88L	25	NEVIUS
75	7		712-233	296		718-192	228	HOPKINS	AM-88R	25	NEVIUS
76S	4		712-241	229,295	WOODSON	718-204	306		AM-101	28	HULL
79	8		712-242	295	WOODSON	718-204S	306		AM-103	30	
79A	8		712-243	295	WOODSON	718-204SD	306		AM-150	24	CRYER
86A	7		712-251	296		718-210	239	SCHLUGER	AM-150A	24	CRYER
87	9		712-256	296		718-212	239	BUCK	AM-150AS	33	
89	9		712-259	296		718-212S	239	SUGARMAN	AM-150S	33	CRYER
90	9		712-PFI	294		718-214S	239	SUGARMAN	AM-150X	32	
707-1N	290	NABERS	713-101	299		718-215	204	OBWEGESER-FREER	AM-151	28	
707-2N	290	NABERS	713-102	299		718-216	204	OBWEGESER-FREER	AM-151AS	33	
707-3GF	289	GOLDMAN-FOX	714-101	294		718-223	228	MEAD	AM-151S	33	CRYER
707-3UM	290	UNIV. MICHIGAN	714-102	294		718-232	303	LANGER	AM-151X	32	
707-3W	289	WILLIAMS	714-CV11	299		718-234	303	LANGER	AM-203	29	
707-6D1	288		715-101	297	HOLLENBACK	718-251	303	DE MARCO	AM-210	27	
707-6D2	288		715-102	297	HOLLENBACK	718-252	303	DE MARCO	AM-222	31	
707-6D3	288		715-103	297	HOLLENBACK	718-268	307	I. UNIVERSITY	AM-250	31	COHEN
707-16D1	288		715-103S	297	HOLLENBACK	718-271	304	GOLDMAN-FOX	AM-451	9	
707-16D2	288		715-311	291	IPC	718-272	304	GOLDMAN-FOX	AMG-150	34	CRYER
707-16GF	289	GOLDMAN-FOX	715-312	291	IPC	718-273	304	GOLDMAN-FOX	AMG-150S	34	CRYER
707-16UM	290	UNIV. MICHIGAN	715-404	297	HOLLENBACK	718-274	304	GOLDMAN-FOX	AMG-151	34	CRYER
707-16W	289	WILLIAMS	715-408	297	HOLLENBACK	718-275	304	GOLDMAN-FOX	AMG-151S	34	CRYER
707-17GF	289	GOLDMAN-FOX	716-101	299		718-277	304	GOLDMAN-FOX	APICAL-1	52	APICAL
707-17UM	290	UNIV. MICHIGAN	716-102	299		718-282	305	McCALL	APICAL-2	52	APICAL
707-17W	289	WILLIAMS	716-103	299		718-282A	305	McCALL	APICAL-3	52	APICAL
707-23D1	288		716-104	299		718-284	305	McCALL	APICAL-4	52	APICAL
707-23D2	288		716-201	298	BLACK	718-284S	305	McCALL	AT-1	268	
707-23GF	289	GOLDMAN-FOX	716-202	298	BLACK	718-288S	305	McCALL	AT-2L	268	
707-23UM	290	UNIV. MICHIGAN	716-203	298	BLACK	718-332	305	JAQUETTE	AT-2R	268	
707-23W	289	WILLIAMS	716-204	298	BLACK	718-333	305	JAQUETTE	AT-6	268	
707-202	288		716-211	298	BLACK	718-335	305	JAQUETTE	AT-12	268	MITCHEL
707-202A	288		716-212	298	BLACK	718-C103	306		B-3	281	
707-203	288		716-232	298	WEDELSTAEDT	718-CK3	301	CRANE-KAPLAN	B-4	281	
707-2311	290	WILLIAMS	716-234	298	WEDELSTAEDT	718-CK6	306	CRANE-KAPLAN	B-28/29	281	WHITE
707-2312	290	WILLIAMS	716-236	298	WEDELSTAEDT	718-EN1	229		B-31/32	281	WHITE
707-GFW	289	GOLD.-FOX-WILLIAMS	717-6	300		718-EN2	229		B-32	281	WHITE
707-UT1	288		717-14	300		718-EN3	229		B-33	281	WHITE
711-301	291	HEIDEMANN	717-17	300		718-GF14	227	GOLDMAN-FOX	B-34	281	WHITE
711-302	291	HEIDEMANN	717-17W	300		718-M23	267		B-35	281	BENNET
711-303	291	HEIDEMANN	717-18	300		718-M23A	267		BB-46	75	
712-18	292		717-18W	300		718-M23B	267		BB-48	75	
712-27S	292		717-19	300		718-M8	227	MOLT	BD-01	120	COLLEGE
712-29	292		717-19W	300		718-M9	226	MOLT	BD-02	120	COLLEGE
712-101	292		717-31L	300		718-PR3	226	PRICHARD	BD-03	120	COLLEGE
712-102	292		717-32L	300		718-RO-4	307		BD-04	124	GRAEFE
712-103	292		717-33L	300		718-T03	306	TAYLOR	BD-05	124	PERRY
712-104	292		717-39	300		718-YG08	306	YOUNGER-GOOD	BD-06	124	
712-105	292		717-64	300		719-111	307	TOWNER-JAQUETTE	BD-07	124	GRAEFE
712-106	292		717-66	300		719-125	307	TOWNER-JAQUETTE	BD-09	134	
712-111	293		717-100	300		719-126	307	TOWNER-JAQUETTE	BD-09T	118	
712-111L	293		717-101	300		720-85	232	LUCAS	BD-10	125	
712-112	293		717-102	300		720-85Z	232	LUCAS	BD-11	120	CAULK
712-112L	293		717-103	300		720-86	232	LUCAS	BD-14	135	POTTS-SMITH
712-113	293		717-104	300		720-86Z	232	LUCAS	BD-16	125	
712-113L	293		717-111	300		720-87	232	LUCAS	BD-18	134	
712-120L	293		717-112	300		720-88	232	LUCAS	BD-19	128	
712-121	293		718-1/2	302	GRACEY	720-101	232	HEMINGWAY	BD-20	134	
712-121L	293		718-2R	303	COLUMBIA	720-102	232	HEMINGWAY	BD-21	128	

Alphanumeric Codes

CODE	PP.	ID	CODE	PP.	ID	CODE	PP.	ID	CODE	PP.	ID
BD-23	134		BD-207	114	ADSON	BF-10	167	GROSS	BT-80	182	MIDDELORPF
BD-25	134		BD-208	114	ADSON	BF-12	167	GROSS	BT-81	182	MIDDELORPF
BD-26	134		BD-209	114	ADSON	BF-20	167	LISTER	BT-82	182	MIDDELORPF
BD-27	138	RUSSIAN	BD-210	137		BF-22	167	PEAN-MURPHY	BT-90	182	KIRSCH
BD-30	132	ADSON	BD-211	137		BF-23	167	PEAN-MURPHY	BT-91	182	KIRSCH
BD-30T	118	ADSON	BD-212	137		BF-24	167	PEAN-MURPHY	BT-92	183	OBWEGESER
BD-31	132	ADSON	BD-213	137		BF-25	167	PEAN-MURPHY	BT-93	183	OBWEGESER
BD-31T	118	ADSON	BD-216	137	SEMKEN	BF-38	165	SCHAEDEL	BT-94	183	OBWEGESER
BD-32	124		BD-217	137	SEMKEN	BF-40	165	FAURE	BT-95	183	OBWEGESER
BD-33	124		BD-221	137		BF-41	165	BACKHAUS	BT-96	183	OBWEGESER
BD-35	124		BD-222	137		BF-42	165	BACKHAUS	BT-100	183	OBWEGESER
BD-36	124		BD-223	137		BF-43	165	BACKHAUS	BT-109	180	LAHEY
BD-38	128		BD-224	137		BF-44	165	BACKHAUS	BT-117	179	KOCHER
BD-39	128		BD-230	136	ADSON	BF-45	165	BACKHAUS	BT-118	179	KOCHER
BD-40	127		BD-231	136	ADSON	BF-46	165	BACKHAUS	BT-131	194	GREENE
BD-41	127		BD-232	136	WANGENSTEEN	BF-48	165	JONES	BT-132	194	
BD-42	127		BD-240	126		BF-50	166	LORNA	BT-134	181	DOCKHORN
BD-43	127		BD-241	126		BF-52	166		BT-135	181	DOCKHORN
BD-44	127		BD-242	126		BF-75	166		BT-139	180	KOCHER
BD-45	127		BD-243	126		BF-94	167	GROSS	BT-140	180	KOCHER
BD-46	127		BD-244	126		BF-95	167	GROSS	BT-152	183	OBWEGESER
BD-47	127		BD-245	126		BM-01	157	OLSEN-HEGAR	BT-153	183	OBWEGESER
BD-51	133	BEASLEY-BABCOCK	BD-246	126		BM-02	157	OLSEN-HEGAR	BT-154	183	OBWEGESER
BD-53	135	POTTS-SMITH	BD-247	126		BM-03	157	OLSEN-HEGAR	BT-155	183	OBWEGESER
BD-56	130		BD-248	126		BM-04	157	OLSEN-HEGAR	BT-156	183	OBWEGESER
BD-57	130		BD-249	126		BM-61	150	OLSEN-HEGAR	BT-157	183	OBWEGESER
BD-58	130		BD-250	136	ADSON	BM-62	150	OLSEN-HEGAR	BT-158	192	MISCH
BD-59	130		BD-251	136	ADSON	BM-63	150	OLSEN-HEGAR	BT-159	192	MISCH
BD-60	126		BD-253	114	ADSON-BROWN	BS-59	322		BT-183	225	HENAHAN
BD-61	126	STILLE	BD-267	137	DE BAKEY	BS-60	322		BT-184	225	HENAHAN
BD-62	126		BD-270	125		BS-61	322		BT-185	225	HENAHAN
BD-63	126	STILLE	BD-270T	118		BS-905	322		BT-186	177	LANGENBECK
BD-65	126	STILLE	BD-271	134		BS-910	322		BT-187	177	LANGENBECK
BD-67	126	STILLE	BD-272	134		BS-915	322		BT-188	177	LANGENBECK
BD-70	132	ADSON	BD-273	134		BS-920	322		BT-189	177	LANGENBECK
BD-71	122,132	ADSON	BD-274	134		BT-07	225		BT-210	177	JOSEPH
BD-72	132	ADSON	BD-275	134		BT-07M	225		BT-211	177	JOSEPH
BD-73	122,132	ADSON	BD-276	134		BT-1	179	HURD	BT-212	177	JOSEPH
BD-75	125		BD-279	123	McINDOE	BT-2	179	HURD	BT-213	177	JOSEPH
BD-75T	118		BD-280	123	GILLIES	BT-05	225	HENAHAN	BT-214	177	JOSEPH
BD-76	125		BD-281	128		BT-06	225	HENAHAN	BT-260	184	LANGENBECK
BD-80	122	DE BAKEY	BD-282	128	ADSON-BROWN	BT-07	225	HENAHAN	BT-264	181	
BD-80T	118	DE BAKEY	BD-283	123	McINDOE	BT-07M	225	HENAHAN	BT-265	181	
BD-81	122	DE BAKEY	BD-284	123	GILLIES	BT-15	177	GILLIES	BT-283	190	ROUX
BD-82	122	DE BAKEY	BD-285T	118		BT-16	177	GILLIES	BT-284	190	ROUX
BD-83	122	DE BAKEY	BD-287	135	POTTS-SMITH	BT-18	179	SEAN-MILLER	BT-285	190	ROUX
BD-90	131	ADSON	BD-288	135	POTTS-SMITH	BT-19	179	SEAN-MILLER	BT-286	190	ROUX
BD-91	127	SEMKEN	BD-289	135	POTTS-SMITH	BT-20	190	FARABEUF	BT-287	190	ROUX-MAGNUS
BD-92	131	ADSON-BROWN	BD-290	135		BT-25	190	FARABEUF	BT-288	190	ROUX-MAGNUS
BD-93	131	ADSON-BROWN	BD-291	135		BT-26	180	RAGNELL-DAVIS	BT-289	190	ROUX-MAGNUS
BD-94	131	BROWN	BD-292	135		BT-27	180	RAGNELL	BV-23	220	WEITLANER
BD-95	127	SEMKEN	BD-348	114	CASTROVIEJO	BT-29	180	CUSHING	C-1	233	HEMINGWAY
BD-96	124	GRAEFE	BD-349	114	BROWN	BT-33	184	LANGENBECK	C-2	233	HEMINGWAY
BD-97	125		BD-351	135		BT-34	184	LANGENBECK	C-3	233	HEMINGWAY
BD-98	125		BD-352	135		BT-35	184	LANGENBECK	C-4	233	HEMINGWAY
BD-99	125		BD-353	135		BT-36	184	LANGENBECK	C-11	317	
BD-104	128		BD-354	135		BT-38	178		C-12	317	
BD-109	128		BD-355	135		BT-39	178		C-13	317	
BD-110	128		BD-356	135		BT-40	178		C-30	317	
BD-111	128		BD-360	113		BT-41	178		C-34	317	
BD-130	130	DESMARRES	BD-361	113		BT-42	178		C-35	317	
BD-131	130	DESMARRES	BD-362	113		BT-43	184	LANGENBECK	C-36	317	
BD-133	128		BD-363	113		BT-44	178		C-41	317	
BD-134	128		BD-364	113		BT-45	178		C-42	317	
BD-135	133	GRAEFE	BD-365	113		BT-46	178		C-43	317	
BD-137	128		BD-366	113		BT-48	180	SENN-GREEN	C-71	316	
BD-141	131	ADSON-BROWN	BD-367	113		BT-49	180	SENN-GREEN	C-72	316	
BD-142	126		BD-370	132	ADSON	BT-50	178		C-73	316	
BD-143	126		BD-371	132	ADSON	BT-51	178		C-74	316	
BD-144	128		BD-372	133	ADSON	BT-52	178		CD-1	276	
BD-145	125		BD-373	133	ADSON	BT-54	178		CD-2	276	
BD-148	125		BD-377	133	ADSON	BT-55	178		CD-3	276	
BD-158	138		BD-378	133	ADSON	BT-56	178		CD-4	276	
BD-159	138		BD-379	133	ADSON	BT-60	184	LANGENBECK	CH-1	70	CHOMPRET
BD-160	122	DE BAKEY	BD-380	131	ADSON	BT-62	184	LANGENBECK	CH-2	70	CHOMPRET
BD-160T	118	DE BAKEY	BD-381	131	ADSON	BT-64	184	LANGENBECK	CH-3	70	CHOMPRET
BD-161	122	DE BAKEY	BD-382	131		BT-66	184	LANGENBECK	CH-4	70	CHOMPRET
BD-165	122		BEIN-1T	51	BEIN	BT-67	187	OBWEGESER	CH-11	70	CHOMPRET
BD-175	138	RUSSIAN	BEIN-1Z	57	BEIN	BT-68	187	OBWEGESER	CH-12	70	CHOMPRET
BD-177	122	ADSON	BEIN-2	51	BEIN	BT-69	194	WASSMUND	CH-13	70	CHOMPRET
BD-178	122	ADSON	BEIN-2Z	57	BEIN	BT-70	179	DESMARRES	CH-14	70	CHOMPRET
BD-194	124	GRAEFE	BEIN-3	51	BEIN	BT-72	179		CO-1	54	COUPLAND
BD-195	124	GRAEFE	BEIN-4	51	BEIN	BT-74	179		CO-2	54	COUPLAND
BD-196	124	GRAEFE	BEIN-4Z	57	LINDO-LEVIEN	BT-77	179	DESMARRES	CO-3	54	COUPLAND

Alphanumeric Codes

CODE	PP.	ID	CODE	PP.	ID	CODE	PP.	ID	CODE	PP.	ID
CO-11	54	COUPLAND	DF-03/9	312		DL-60	318	UNIVERSAL	DO-184	202	EPKER
CO-12	54	COUPLAND	DF-03/10	312		DL-61	62		DO-185	202	EPKER
CO-13	54	COUPLAND	DF-03/11	312		DL-62	62		DO-186	202	EPKER
COL-1/2	261	LANGER	DF-03/12	312		DL-63	62		DO-196	200	
COL-2RL	261	COLUMBIA	DF-03/13	312		DL-64	64	WINTER	DO-204	184	
COL-3/4	261	LANGER	DF-04	312	NYSTRÖM	DL-65	64	WINTER	DO-204L	184	
COL-4RL	261	COLUMBIA	DF-05/5	312		DL-66	64	WINTER	DO-212	184	AUSTIN
COL-13/14	261	COLUMBIA	DF-05/6	312		DL-67	64	WINTER	DP-24	315	
COLLEGE	120	COLLEGE	DF-05/7	312		DL-68	62		DP-24C	315	
COLLEGE-S	120	COLLEGE	DF-06	312	IVORY	DL-69	62		DP-24R	315	
CS-01	214		DF-07	312	TOFFLEMIRE	DL-73	61	BERNARD	DP-28	315	BÖHM
CS-02	214		DF-08	312	IVORY	DL-74	61	BERNARD	DP-29	315	BÖHM
CS-03	214		DF-09	312	IVORY	DL-75	61	BERNARD	DP-38	315	FURRER
CS-04	214		DF-10	309	BREWSTER	DL-76	49		DP-38A	315	KERLING
CS-05	214		DF-12	310	IVORY	DL-77	49		DP-38R	315	
CS-06	214		DF-15	309	PALMER	DL-78	49		DP-90	109	
CU-1/2	261	GRACEY	DF-16	309	STOKE	DL-79	49		DP-91	109	BEEBE
CU-3/4	261	GRACEY	DF-18	309		DL-81	44		DP-92	109	BEEBE
CU-5/6	261	GRACEY	DF-30	311		DL-82	44		DP-101	109	BEEBE
CU-7/8	261	GRACEY	DF-32	311		DL-83	44		DP-102	109	BEEBE
CU-9/10	261	GRACEY	DF-40	310	IVORY	DL-84	44		DP-103	109	BEEBE
CU-11/12	261	GRACEY	DF-40/1	310		DL-85	44		DP-104	109	BEEBE
CU-13/14	261	GRACEY	DF-40/2	310		DL-86	44		DP-105	109	BEEBE
CU-MC1	231	MILLER-COLBURN	DF-40/3	310		DL-87	44		DP-120	107	
CV-11	276		DF-41	310	IVORY	DL-88	62		DP-136	318	
DA-01	40		DF-41/4	310		DL-89	62		DP-137	318	
DA-01M	40		DF-41/5	310		DL-90	65	LECLUSE	DR-40	39,169	PEET
DA-02	40		DF-41/6	310		DL-91	45		DR-50	39	STIEGLITZ
DA-03	40		DF-43	310	IVORY	DL-92	45		DR-60	39	STIEGLITZ
DA-04	121		DF-126	311	IVORY	DL-93	45		DR-70	39	STIEGLITZ
DA-05	121		DF-127	311	IVORY	DL-94	45		DR-78	138	MILLER
DA-06	138		DF-128	311	IVORY	DL-95	45		DR-80	138	MILLER
DA-07	138	CORN	DF-129	311	IVORY	DL-96	45		E-0	284	
DA-08	138		DF-130	311	IVORY	DL-97	45		E-1	284	
DA-09	121		DF-131	311	IVORY	DL-98	60	POTT	E-2	284	
DA-10	40		DF-151	311	IVORY	DL-99	60	POTT	E-3	284	
DA-11	121		DF-160	311	IVORY	DL-100	63	WINTER	E-4	284	
DB-01	123	CRANE-CAPLAN	DK-26	38	WITZEL	DL-101	63	WINTER	EC-1	284	
DB-02	123	CRANE-CAPLAN	DK-28	38	WITZEL	DL-102	46		EC-2	284	
DB-07	322		DL-0	318		DL-103	46		EN-M1	228	
DB-08	322		DL-1	53	KRALLENHEBER	DL-104	46		EN-M2	228	
DB-1L	322	CLEANLACT	DL-2	53	KRALLENHEBER	DL-105	46		EN-M3	228	
DB-3	322	INDIA	DL-05	58	FAHRENKRUG	DL-106	43		EN-M4	228	
DB-4	322	ARKANSAS	DL-06	58	FAHRENKRUG	DL-107	43		EN-M5	228	
DB-6A	322		DL-11	56	HYLIN	DL-108	65	BARRY	EN-M6	228	
DB-10M	322	CLEANLACT	DL-13	56	HYLIN	DL-109	65	BARRY	EN-M7	228	
DB-11	322		DL-14	56	HYLIN	DL-110	65		ES-13	204	
DB-12	322		DL-17	56	HYLIN	DL-111	65		ES-27	229	
DB-15	322		DL-18	56	HYLIN	DL-112	46		ES-44	130	KÜHNE
DB-50M	322	CLEANLACT	DL-19	56	HYLIN	DL-113	46		ES-65	130	BARRAQUER
DB-71	322	CERAMIC	DL-20	48	WARWICK-JAMES	DL-114	46		EX-11	252	WILLIAMS
DB-96	322	ARKANSAS	DL-21	48	WARWICK-JAMES	DL-115	46		EX-12	252	WILLIAMS
DB-177	246	CITELLI	DL-22	48	WARWICK-JAMES	DL-116	43		F-2/3	276	
DB-178	246	CITELLI	DL-24	60	POTT	DL-117	43		FD-06	84	
DB-179	246	CITELLI	DL-25	60	POTT	DL-118	43		FD-08	84	
DB-180	246	CITELLI	DL-27	53	CRYER	DL-123	61	BERNARD	FD-10	83	NOYES
DB-181	246	CITELLI	DL-28	53	CRYER	DL-124	61	BERNARD	FD-12	83	NOYES
DB-182	246	CITELLI	DL-30	57	KOPP	DL-190	58		FD-13	83	WESTCOTT
DB-183	246	CITELLI	DL-31	57	KOPP	DL-191	58		FD-14	141	
DB-299	322	ARKANSAS	DL-32	53	CRYER	DL-C	318		FD-15	83	
DB-300	219		DL-33	53	CRYER	DL-V	318		FD-16	141	
DB-941	322		DL-34	50	APEXO	DO-1	238	HOWARD	FD-17	141	CASTROVIEJO
DB-OL	322		DL-34S	50	APEXO	DO-2	238	HOWARD	FD-18	144	CASTROVIEJO
DEAN	94	DEAN	DL-35	50	APEXO	DO-3	238	HOWARD	FD-19	141	CASTROVIEJO
DEAN-TC	102	DEAN	DL-36	50	APEXO	DO-4	238	HOWARD	FD-20	144	CASTROVIEJO
DF-00	308	IVORY	DL-37	50	APEXO	DO-4C	238	HOWARD	FD-21	146	CASTROVIEJO
DF-00L	308		DL-38	50	APEXO	DO-5	238	HOWARD	FD-22	144	CASTROVIEJO
DF-00M	308		DL-42	43	BEIN	DO-08	186	WIEDER	FD-22A	144	CASTROVIEJO
DF-00N	308		DL-43	43	BEIN	DO-09	186	WIEDER	FD-23	146	CASTROVIEJO
DF-00P	308		DL-44	43	BEIN	DO-40	186	WIEDER	FD-24	142	BARRAQUER
DF-00R	308		DL-45	43		DO-41	192	OBWEGESER	FD-25	145	JACOBSON
DF-00V	308		DL-46	43		DO-59	223	OBWEGESER	FD-26	141	
DF-01/5	312		DL-47	43		DO-63	223	OBWEGESER	FD-28	144	CASTROVIEJO
DF-01/6	312		DL-48	59		DO-65	223	OBWEGESER	FD-29	145	JACOBSON
DF-01/7	312		DL-48S	59		DO-67	223	OBWEGESER	FD-30	145	JACOBSON
DF-02	308	AINSWORTH	DL-49	59		DO-140	202	COTTLE	FD-31	143	CASTROVIEJO
DF-02M	308		DL-49S	59		DO-141	202	COTTLE	FD-32	145	JACOBSON
DF-02P	308		DL-50	234		DO-142	192	OBWEGESER	FD-33	146	DIETRICH
DF-02R	308		DL-51	234		DO-143	202	COTTLE	FD-34	143	CASTROVIEJO
DF-03/1	312		DL-52	234		DO-175	184	BOWLED-HENRY	FD-35	146	DIETRICH
DF-03/2	312		DL-54	59		DO-180	202	EPKER	FD-36	143	CASTROVIEJO
DF-03/3	312		DL-55	59		DO-181	202	EPKER	FD-37	143	CASTROVIEJO
DF-03/7	312		DL-58	48	ROSIN	DO-182	202	EPKER	FD-38	141	STEVENS
DF-03/8	312		DL-59	62		DO-183	202	EPKER	FD-41	83	

Alphanumeric Codes

CODE	PP.	ID	CODE	PP.	ID	CODE	PP.	ID	CODE	PP.	ID
FD-42	83		FG-112	86	COTTLE-KNAPP	FL-01	203		FL-185	201	PARTSCH
FD-64	83	WESTCOTT	FG-113	86	COTTLE-KNAPP	FL-03	201	PARTSCH	FL-186	201	PARTSCH
FD-65	83	WESTCOTT	FG-121	91	KILNER	FL-04	201	PARTSCH	FL-187	201	PARTSCH
FD-137	83		FG-123	87	JAMESON-WERBER	FL-05	201	PARTSCH	FL-188	201	PARTSCH
FD-138	83		FG-124	87	JAMESON	FL-09	203	MEAD	FL-189	201	PARTSCH
FD-145	84		FG-147	89	JOSEPH	FL-09R	203	MEAD	FL-230	202	LEXER
FD-170	145		FG-148	89	JOSEPH	FL-10M	203	LUCAE	FL-231	202	LEXER
FD-171	145		FG-153	106	JOSEPH	FL-11	203	MEAD	FL-232	202	LEXER
FD-172	143		FG-154	106	JOSEPH	FL-11R	203	MEAD	FL-263	199	LAMBOT
FD-173	143	CASTROVIEJO	FG-156	87		FL-12	203	MEAD	FL-264	199	LAMBOT
FD-182	84		FG-157	87		FL-12R	203	MEAD	FL-265	199	LAMBOT
FD-183	84		FG-158	87		FL-13	201	PARTSCH	FL-266	199	LAMBOT
FD-216	142	BARRAQUER	FG-159	87		FL-14	201	PARTSCH	FL-267	199	LAMBOT
FD-217	142	BARRAQUER	FG-160	107	SMITH	FL-15	201	PARTSCH	FL-268	199	LAMBOT
FD-224	84		FG-161	107	SMITH	FL-16	199	LAMBOT	FL-269	199	LAMBOT
FD-225	84		FG-167	101	SMITH	FL-17	199	LAMBOT	FL-292	209	
FD-236	142	BARRAQUER	FG-168	101		FL-18	199	LAMBOT	FL-293	209	
FD-237	142	BARRAQUER	FG-190	91	GOLDMAN-FOX	FL-20	216		FL-294	209	
FD-562T	147		FG-191	91	GOLDMAN-FOX	FL-21	216		FL-295	209	
FD-563T	147		FG-207	85		FL-25	212		FL-296	209	
FD-574T	147		FG-208	85		FL-26	212		FL-297	209	
FD-575T	147		FG-209	85	STEVENS	FL-27	212		FL-298	209	
FD-587T	147		FG-210	85	STEVENS	FL-28	212		FL-299	209	
FD-588T	147		FG-211	85	WALTON	FL-31	216		FL-389	207	
FD-599	146		FG-212	85	WALTON	FL-32	199	LAMBOT	FL-390	207	
FD-600	146		FG-216	85	STITCH	FL-33	216		FL-391	207	
FD-601	146		FK-1	92	KELLY	FL-35	216		FL-392	207	
FD-602	146		FK-15C	102	KELLY	FL-37	212		FL-393	207	
FD-730	148	CASTROVIEJO	FK-1TC	102	KELLY	FL-38	212		FL-394	207	
FD-731	148	CASTROVIEJO	FK-2	92	KELLY	FL-39	212		FL-395	207	
FE-1	273	FELT	FK-25C	102	KELLY	FL-53	199	LAMBOT	FL-396	207	
FE-2	273	FELT	FK-2TC	102	KELLY	FL-54	199	LAMBOT	FL-397	207	
FE-3	273	FELT	FK-60	236	VOLKMANN	FL-58	199	LAMBOT	FL-398	207	
FE-4	273	FELT	FK-61	236	VOLKMANN	FL-59	202	LEXER	FL-399	207	
FE-4/5	273	FELT	FK-62	236	VOLKMANN	FL-60	202	LEXER	FL-411	202	
FE-5	273	FELT	FK-63	236	VOLKMANN	FL-61	202	LEXER	FL-412	202	
FE-6	273	FELT	FK-64	236	VOLKMANN	FL-65	211		FL-413	202	TESSIER
FG-1	86	IRIS	FK-65	236	VOLKMANN	FL-66	211		FL-414	202	TESSIER
FG-15C	104	IRIS	FK-66	236	VOLKMANN	FL-67	211		FL-415	202	TESSIER
FG-15CZ	104	IRIS	FK-67	236	VOLKMANN	FL-68	211		FL-416	202	TESSIER
FG-1TC	101	IRIS	FK-70	235	MARTINI	FL-69	211		FLAGG	120	FLAGG
FG-2	86	IRIS	FK-71	235	MARTINI	FL-70	211		FLOHR-1	52	FLOHR
FG-25C	104	IRIS	FK-72	235	VOLKMANN	FL-71	211		FLOHR-2	52	FLOHR
FG-25CZ	104	IRIS	FK-73	235	VOLKMANN	FL-72	211		FLOHR-3	52	FLOHR
FG-2TC	101	IRIS	FK-75	235	JACOBSON	FL-73	211		FM-1	98	METZENBAUM
FG-3	87		FK-76	235	MARTINI	FL-74	211		FM-1F	98	METZENBAUM
FG-4	86		FK-77	235	JANSEN	FL-75	211		FM-15C	104	METZENBAUM
FG-5	86		FK-78	235	BARTH	FL-76	211		FM-2	98	METZENBAUM
FG-11L	86	IRIS	FK-83	234		FL-77	211		FM-2F	98	METZENBAUM
FG-12L	86	IRIS	FK-84	234	JANSEN	FL-78	211		FM-25C	104	METZENBAUM
FG-13	88	IRIS	FK-87	92	KELLY	FL-79	211		FM-3	99	METZENBAUM
FG-14	89	METZENBAUM	FK-88	92	KELLY	FL-80	211		FM-3F	99	METZENBAUM-FINO
FG-15	88		FK-100	205		FL-104	203	COTTLE	FM-35C	104	METZENBAUM
FG-19C	93	KILNER	FK-101	205		FL-114	200		FM-4	99	METZENBAUM
FG-19R	93	KILNER	FK-102	205		FL-115	200		FM-4F	99	METZENBAUM-FINO
FG-20	94	NEUMANN	FK-103	205		FL-116	200		FM-45C	104	METZENBAUM
FG-21	90		FK-104	205		FL-120	208		FM-5	96	MAYO
FG-22	90		FK-105	205		FL-121	208		FM-55C	104	MAYO
FG-23	88		FK-106	205		FL-122	208		FM-6	96	MAYO
FG-24	88		FK-107	205		FL-123	208		FM-65C	104	
FG-28	89	METZENBAUM	FK-108	205		FL-124	208		FM-7	96	
FG-36	90		FK-109	205		FL-125	208		FM-8	96	
FG-37	90		FK-110	236	BRUNS	FL-128	203	HAJEK	FM-9	96	
FG-38	95	QUINBY	FK-111	236	BRUNS	FL-132	200		FM-10	96	
FG-39	95	CHADWICK	FK-112	236	BRUNS	FL-135	200		FM-12	89	METZENBAUM
FG-50	93	STEVENS	FK-113	236	BRUNS	FL-136	200		FM-27	96	
FG-51	93	STEVENS	FK-114	236	BRUNS	FL-141	210		FM-28	96	
FG-52	93	STEVENS	FK-115	236	BRUNS	FL-142	210		FM-41	96	
FG-53	93	STEVENS	FK-116	236	BRUNS	FL-143	210		FM-42	96	
FG-54	93	REYNOLDS	FK-120	236	SCHEDÉ	FL-144	210		FM-47	98	METZENBAUM
FG-55	93	REYNOLDS	FK-121	236	SCHEDÉ	FL-150	213	KEYES	FM-48	98	METZENBAUM
FG-58	87	KILNER	FK-122	236	SCHEDÉ	FL-151	213	KEYES	FM-49	96	
FG-59	86	COTTLE	FK-123	236	SCHEDÉ	FL-152	213	KEYES	FM-49	96	
FG-60	98	TOENNIS-ADSON	FK-124	236	SCHEDÉ	FL-153	213	KEYES	FM-51	107	
FG-61	98	TOENNIS-ADSON	FK-125	236	SCHEDÉ	FL-155	213	KEYES	FM-59	107	
FG-66	93	KILNER	FK-126	236	SCHEDÉ	FL-155	213	KEYES	FM-63	96	
FG-67	93	KILNER	FK-126	236	SCHEDÉ	FL-156	213	KEYES	FM-66	99	METZENBAUM
FG-92	106	PECK-JOSEPH	FK-136	234	KERPEL	FL-157	213	KEYES	FM-67	99	METZENBAUM
FG-98	106		FK-137	234	KERPEL	FL-158	213	KEYES	FM-68	99	METZENBAUM
FG-101	90		FK-138	234	KERPEL	FL-159	213	KEYES	FM-69	99	METZENBAUM
FG-102	90		FK-139	234	KERPEL	FL-177	201	PARTSCH	FM-79	95	MAYO-LEXER
FG-103	88		FK-188	234	UFFENORDE	FL-179	201	PARTSCH	FM-96	100	METZENBAUM-FINO
FG-104	88		FK-189	234	UFFENORDE	FL-181	201	PARTSCH	FM-97	100	METZENBAUM-FINO
FG-105	88		FK-197	234	WILLIGER	FL-183	201	PARTSCH	FM-98	100	METZENBAUM-FINO
			FK-198	234	WILLIGER	FL-184	201	PARTSCH	FM-99	100	METZENBAUM-FINO

Alphanumeric Codes

CODE	PP.	ID	CODE	PP.	ID	CODE	PP.	ID	CODE	PP.	ID
FM-100	103	IRIS	G-26	258		I-133L	23		LB-23	78	
FM-100L	103	IRIS	G-28	258		I-133R	23		LB-40	75	
FM-102	103	METZENBAUM	G-30	258		I-333S	23		LB-361	75	
FM-104	103	METZENBAUM	GA-17	215		I-401	38		LB-362	75	
FM-109	89	METZENBAUM	GA-18	215		IM-15	214		LB-363	75	
FM-118	101	METZENBAUM	GA-19	215		KE-20	196		LB-364	75	
FM-119	101	METZENBAUM	GA-20	215		KE-40	196		LB-365	75	
FM-126	89	METZENBAUM	GA-33	213		KKD-1	287	KIRKLAND	LB-366	75	
FM-127	89	METZENBAUM	GA-34	213		KKD-2	287	KIRKLAND	LB-367	75	
FM-146	107		GA-35	213		KKD-4	287	KIRKLAND	LB-368	75	
FM-180	95	LEXER	GA-36	213		KN-55	200	KRAMER-NEVINS	LB-369	75	
FM-181	95	LEXER	GA-37	213		KN-75	200	KRAMER-NEVINS	LG-1	94	LA GRANGE
FM-201	100	METZENBAUM-FINO	GA-60	213		KO-1	224	KÖNIG	LG-15C	105	LA GRANGE
FM-202	100	METZENBAUM-FINO	GA-63	213		KO-2	224	KÖNIG	LG-25C	105	LA GRANGE
FM-203	100	METZENBAUM-FINO	GA-64	213		KO-3	224	KÖNIG	LG-6	94	LA GRANGE
FM-204	100	METZENBAUM-FINO	GA-65	213		KO-11	227	KILIAN	LK-1	90	LOCKLIN
FM-298	97	METZENBAUM	GA-66	213		KO-20	229	BABBUSH	LK-2	92	LOCKLIN
FM-299	97	METZENBAUM	GA-70	216		KO-22	224	SELDIN	LK-3	90	LOCKLIN
FM-300	97	STEVENS	GA-71	217		KO-23	224	SELDIN	LK-4	92	LOCKLIN
FM-301	97	STEVENS	GA-73	217		KO-58	226	BENNETT	LK-10	102	
FM-317	101	GREENBERG-PAR	GA-78	217		KO-66	227	ROGER	LK-12	102	
FM-318	97	METZENBAUM	GA-79	217		L-0	72		LS-08	218	
FM-319	97	METZENBAUM	GA-80	217		L-1	72		LS-09	218	
FM-339	106	GREGORY	GA-81	217		L-2	72		LX-50	240	ILIC
FM-350	101	KILNER	GA-85	217		L-3	72		LX-52	240	
FO-08	242	BLUMENTHAL	GA-86	217		L-4	72		LX-60	240	CHOEN
FO-09	242	BLUMENTHAL	GA-90	217		L-5	72		LX-113	220	WOLFF
FO-15	242	FRIEDMANN	GA-91	217		L-6	72		MA-1	257	
FO-16	244	FRIEDMANN	GB-2	78		L-7	72		MA-1A	257	
FO-17	242	FRIEDMANN	GB-4	76		L-8	72		MA-2	257	
FO-18	243	LUER	GF-133	214		L-9	72		MA-2A	257	
FO-19	242	BLUMENTHAL	GF-134	214		L-11	72		MA-3	257	
FO-20	244	BEYER	GF-200	320		L-21	72		MA-6	258	
FO-21	242	MEAD	GFC	91	GOLDMAN-FOX	L-22	72		MA-7	257	
FO-22	241	FRIEDMANN	GFC-S	91	GOLDMAN-FOX	L-23	72		MA-7A	257	
FO-23	241	FRIEDMANN	GFC-SC	105	GOLDMAN-FOX	L-24	72		MA-8	71	
FO-24	241	FRIEDMANN	GFC-SZ	91	GOLDMAN-FOX	L-25	72		MA-9	71	
FO-25	243	LEMPERT	GFC-TC	106	GOLDMAN-FOX	L-26	72		MA-9R	71	
FO-26	245	GARDNER	GFR	91	GOLDMAN-FOX	L-27	72		MA-11	75	
FO-33	246		GFR-S	91	GOLDMAN-FOX	L-28	72		MA-B1	77	
FO-34	244	ZAUFAL-JANSEN	GFR-SC	105	GOLDMAN-FOX	L-29	72		MA-B2	77	
FO-43	243	LEMPERT	GFR-TC	106	GOLDMAN-FOX	L-51	71		MA-B3	77	
FO-60	245	BÖHLER	GFS	94	GOLDMAN-FOX	L-52	71		MA-B3M	77	
FO-61	245	BÖHLER	GFS-SC	105	GOLDMAN-FOX	L-53	71		MA-B4	78	
FO-77	245	GARDNER	GM-01	215		L-54	71		MA-B7	77	
FO-85	241	FRIEDMANN	GM-02	215		L-55	71		MA-B7K	77	
FO-87	241	STELLBRINK	GO-1	273	GOLDSTEIN	L-56	71		MA-B8	77	
FO-88	241	STELLBRINK	GO-2	273	GOLDSTEIN	L-57	71		MA-B9	77	
FO-89	241	STELLBRINK	GO-3	273	GOLDSTEIN	L-58	71		MA-B16	76	
FO-130	220	DINGMANN	GO-4	273	GOLDSTEIN	L-59	71		MC-11	71	
FO-131	220	DINGMANN	GS-16	78		L-60	71		MC-12	71	
FO-131S	220	DINGMANN	GS-18	78		L-71	71		MC-13	71	
FO-138	244	RUSKIN	GS-26	109		L-72	71		MC-70	71	
FO-139	244	RUSKIN	H-1	275		L-73	71		MD-1	35	MEAD
FO-156	244	KLEINERT-KUTZ	H-2	275		LA-1	66		MD-2	35	MEAD
FO-157	244	KLEINERT-KUTZ	H-3	275		LA-2	66		MD-3	35	MEAD
FO-159	220	RADOLF	HB	229		LA-3	66		MD-4	35	MEAD
FO-162	246	KERRISON	HE-1	47	HEIDBRINK	LA-4	66		MEAD	223	MEAD
FO-163	246	KERRISON	HE-2	47	HEIDBRINK	LA-5	66		MERIAM	120	MERIAM
FO-165	246	KERRISON	HE-2S	47	HEIDBRINK	LA-6	66		MF-101	129	GERALD
FO-216	242	MEAD	HE-3	47	HEIDBRINK	LA-7	67		MF-101T	118	GERALD
FO-220	241	FRIEDMANN	HE-3S	47	HEIDBRINK	LA-8	67		MF-102	129	GERALD
FO-221	242	FRIEDMANN	HF-3/7	267	HIRSCHFELD	LA-9	67		MF-102T	118	GERALD
FO-229	243	LEMPERT	HF-5/11	267	HIRSCHFELD	LA-10	67		MF-103	129	GERALD
FO-230	243	LEMPERT	HF-9/10	267	HIRSCHFELD	LA-11	68		MF-104	129	GERALD
FO-231	245	CLEVELAND	HP-6	58		LA-12	68		MF-105	129	GERALD
FO-232	245	CLEVELAND	HP-7	58	COGSWELL	LA-13	68		MF-106	136	GERALD
FO-233	245	CLEVELAND	I-13	19		LA-16	68		MF-107	136	GERALD
FO-234	245	CLEVELAND	I-221/2L	22		LA-17	68		MF-110	115	
FR-16	204	FREER	I-221/2R	22		LA-20	69		MF-111	115	
FR-17	204	FREER-YASARGIL	I-22	19		LA-21	69		MF-112	115	
FREER	204,226	FREER	I-36	18		LA-22	69		MF-113	115	
G-3	257		I-36N	18		LA-23	69		MF-114	115	
G-4	257		I-46L	21		LB-10	77		MF-115	115	
G-5	257		I-46LX	21		LB-11	77		MF-124	119	
G-8	258		I-46N	20		LB-12	77		MF-125	119	
G-10	258		I-59	19		LB-12D	77		MF-126	119	
G-12	258		I-73	19		LB-13	77		MF-127	119	
G-14	258		I-74	18		LB-15	77		MF-128	119	
G-16	258		I-74N	18		LB-15A	77		MF-129	119	
G-18	258		I-79	20		LB-15C	77		MF-142T	119	
G-20	258		I-79N	20		LB-18	78		MF-143T	119	
G-22	258		I-86C	19		LB-20	78		MF-144T	119	
G-24	258		I-87	20		LB-21	78		MF-145T	119	

Alphanumeric Codes

CODE	PP.	ID	CODE	PP.	ID	CODE	PP.	ID	CODE	PP.	ID
MF-146T	119		O-2	277		OR-18	218	CASTROVIEJO	P-233	173	CRILE
MF-147T	119		O-3	277		OR-19	218	CASTROVIEJO	P-238	173	HALSTED
MF-177	114	BISHOP-HARMON	O-4	277		OR-20	218		P-239	173	HALSTED
MF-249	114	BISHOP-HARMON	OA-1	279		OR-45	218		P-240	173	HALSTED
MF-370	116		OA-2	279		OS-1	280	WESTCOTT	P-241	173	HALSTED
MF-371	116		OA-3	279		OS-2	280	WESTCOTT	P-250	171	PEAN
MF-372	116		OBN-1	287	ORBAN	OSB-1	286	OCHSENBEIN	P-251	171	PEAN
MF-373	116		OBN-2	287	ORBAN	OSB-2	286	OCHSENBEIN	P-252	171	PEAN
MF-374	116		OBN-4	287	ORBAN	OSB-4	285	OCHSENBEIN	P-253	171	PEAN
MF-375	116		OC-1	278		OSB-4A	285	OCHSENBEIN	P-256	171	PEAN
MF-376	116		OC-2	278		OT-1	271	FELT	P-257	171	PEAN
MF-377	116		OF-1	285	FEDI	OT-2	271	FELT	P-260	171	KOCHER
MF-378	117		OF-2	285	FEDI	OT-3	271	FELT	P-261	171	KOCHER
MF-379	117		OF-3	285	FEDI	OT-4	271	FELT	P-264	168	HARTMANN-MOSQ.
MF-380	117		OK-1	277		OT-5	271	FELT	P-265	168	HARTMANN-MOSQ.
MF-381	117		OK-2	277		OT-6	271	FELT	P-266	168	JACOBSON
MF-382	117		OK-3	277		OT-7	271	GOLDSTEIN	P-267	168	JACOBSON
MF-383	117		OL-1	278		OT-8	271	GOLDSTEIN	P-324	174	JUDD-ALLIS
MF-384	117		OL-2	278		OT-9	271	GOLDSTEIN	P-332	168	DANDY-MOSQUITO
MF-385	117		OL-3	278		OT-10	271	GOLDSTEIN	P-340	219	
MI-10	55	MILLER-APEXO	OM-2	280		OT-11	272		P-341	219	
MI-11	55	MILLER-APEXO	OM-04	195	BRUENINGS	OT-12	272		P-342	219	
MI-12	55	MILLER-APEXO	OM-06	186		OT-13	272		PEB-1	37	
MI-13	55	MILLER-APEXO	OM-07	195		OT-14	272		PEB-2	37	
MIR-08	229	SURGICAL WOODSON	OM-08	186	TOBOLD	OT-15	272		PEB-3	37	
MIR-09	71		OM-10	195	COLLIN	OT-16	272		PEB-4	37	
MIR-10	236	COLLEGE	OM-16	195	KROENIG	OX-1	280		PEB-5	37	
MIR-20	54		OM-18	195	BUCHWALD	OX-2	280		PEB-6	37	
MIR-21	54		OM-19	195	FRENZEL	OX-3	280		PEB-7	37	
MIR-22	54		OM-30	195	COLLIN	OZ-1	278		PEB-17S	36	
MIR-23	54		OM-40	188	MOLT-DOYEN-COLLIN	OZ-2	278		PEB-23S	36	
MIR-24	54		OM-40R	188	MOLT-DOYEN-COLLIN	OZ-3	278		PEB-150S	36	
MIR-25	54		OM-41	188	MOLT-DOYEN-JANSEN	P-0	258		PEB-151S	36	
MIR-26	54		OM-41R	188	MOLT-DOYEN-JANSEN	P-00	258		PF-6	214,256	LUNIATSCHEK
MIR-30	206		OM-42	188	MOLT	P-000	258		PF-9	268	LANGE
MIR-31	206		OM-44	195		P-01	258		PF-40	256	UNIVERSAL
MIR-32	206		OM-45	195	YOUNG	P-02	258		PF-41	256	UNIVERSAL
MIR-33	206		OM-50	191	STERNBERG	P-03	258		PH-37	149	HALSEY
MO-2	237	MOLT	OM-52	191	STERNBERG	P-3	257		PH-38	149	
MO-4	237	MOLT	OM-55	191	MINNESOTA	P-04	258		PH-39	149	DERF
MO-4L	237	MOLT	OM-55B	191	MINNESOTA	P-4	257		PH-40	159	MAYO-HEGAR
MO-4LT	237	MOLT	OM-60	188	ROSER-KÖNIG	P-05	258		PH-41	159	MAYO-HEGAR
MO-4RT	237	MOLT	OM-61	191	BISHOP	P-5	257		PH-42	159	MAYO-HEGAR
MO-8	229	MOLT	OM-62	188	HEISTER	P-06	258		PH-48	149	HALSEY
MO-9A	226	MOLT	OM-66	191	CAWOOD-MINNESOTA	P-15	169		PH-53	153	
MO-10	231,237	MOLT	OM-66B	191	CAWOOD-MINNESOTA	P-49	172	KOCHER	PH-54	156	CRILE-WOOD
MO-12	231	MOLT	OM-67	191	STERNBERG	P-50	174	ALLIS	PH-58	155	
MO-15	225	MOLT	OM-70	196		P-52	174	ALLIS	PH-59	155	HEGAR
MO-20	227	MOLT	OM-71	196		P-61	173	LERICHE	PH-60	316	
MO-24	227	MENEHINI	OM-72	196		P-62	173	LERICHE	PH-61	149	CRILE-WOOD
MOLT-9	226	MOLT	OM-74	189	ORINGER	P-63	173	LERICHE	PH-62	149	CRILE-MURRAY
MPI-1	214		OM-75	189		P-64	173	LERICHE	PH-63	149	HALSEY
MRT/C7	316		OM-76	189		P-79	172	KOCHER	PH-64	149	
MRT-6	316		OM-77	189	ORINGER	P-81	172	CRILE	PH-65	153	
MRT-7	316		OM-80	185		P-82	172	CRILE	PH-66	153	WEBSTER
MRT-C1	317		OM-81	185		P-84	172	KELLY	PH-67	153	HALSEY
MRT-C3	317		OM-82	185		P-85	172	KELLY	PH-68	153	CONVERSE
MRT-C4	317		OM-85	185		P-86	172	CRILE	PH-69	153	DERF
NK-1	76		OM-87	185		P-87	172	CRILE	PH-70	159	MAYO-HEGAR
NK-2	76		OM-88	185		P-89	172	KOCHER	PH-71	156	CRILE-WOOD
NK-3	76		OM-90	189		P-91	170	HALSTED	PH-72	155	HEGAR
NK-06	79	ZIEGLER	OM-97	189	MATY	P-92	170	HALSTED	PH-73	153	HALSEY
NK-07	79	LA FORCE	OM-100	185		P-93	170	HALSTED	PH-74	159	MAYO-HEGAR
NK-08	79	GRAEFE	OM-110	193	DINGMANN	P-94	170	HALSTED	PH-75	155	HEGAR
NK-09	79	ELLIS	OM-112	193	DINGMANN	P-95	170	HALSTED-MOSQUITO	PH-76	155	HEGAR
NK-10	79	ZIEGLER	OM-113	193	DINGMANN	P-96	170	HALSTED-MOSQUITO	PH-77	155	CRILE-WOOD
NK-11	79		OM-114	193	DINGMANN	P-97	170	HALSTED-MOSQUITO	PH-79	152	CRILE-WOOD
NK-12	75		OM-136	193	DINGMANN	P-98	170	HALSTED-MOSQUITO	PH-80	151	RYDER
NK-14	79	GRAEFE	OM-137	193	DINGMANN	P-100	174	ALLIS	PH-81	151	RYDER
NK-16	79	GRAEFE	OM-138	193	DINGMANN	P-101	169	HALSTED	PH-82	151	RYDER
NK-17	79		OM-139	193	DINGMANN	P-102	169	HALSTED	PH-83	151	RYDER
NK-18	79	GRAEFE	ON-1	280		P-115	174	ALLIS	PH-84	151	RYDER
NK-20	79	GRAEFE	OP-1	279		P-120	168	HARTMANN-MOSQ.	PH-85	152	SWEDISH
NK-30	80		OP-2	279		P-121	168	HARTMANN-MOSQ.	PH-90	156	CRILE-WOOD
NK-32	80		OP-3	279		P-129	174	BOYS-ALLIS	PH-99	156	
NK-34	80		OP-4	279		P-135	169	HALSTED	PH-100	156	CRILE-WOOD
NK-36	80		OP-5	279		P-136	171	MIXTER	PH-101	154	MICRO VASCULAR
NK-38	80		OP-6	216		P-137	171	MIXTER	PH-102	154	MICRO VASCULAR
NK-39	79		OP-7	216		P-215	171		PH-103	154	MICRO VASCULAR
NK-40	80		OP-8	216		P-216	171		PH-106	152	SWEDISH
NK-105	204		OR-11	218	CASTROVIEJO	P-217	171		PH-110	154	DE BAKEY
NK-249	204	SAUTTER	OR-12	218	CASTROVIEJO	P-230	173	CRILE	PH-111	154	DE BAKEY
NK-251	204	MODELL-GIESSEN	OR-13	218	CASTROVIEJO	P-231	173	CRILE	PH-120	154	HEGAR
O-1	277		OR-14	218	CASTROVIEJO	P-232	173	CRILE	PH-121	154	HEGAR

Alphanumeric Codes

CODE	PP.	ID	CODE	PP.	ID	CODE	PP.	ID	CODE	PP.	ID
PH-122	154	HEGAR	S-51B	16		SS-42	270		USG-13/14	263	GRACEY
PH-127	154	MAYO-HEGAR-FINO	S-51LX	17		SS-50	269		USG-13/14ET	262	GRACEY
PH-128	154	MAYO-HEGAR-FINO	S-66L	14		SS-51	269		USG-13/14L	264	GRACEY
PH-129	154	MAYO-HEGAR-FINO	S-66R	14		SS-52	269		USG-13/14S	263	GRACEY
PH-132	155	SAROT	S-67L	15		SS-54	269		USG-15/16	264	GRACEY
PH-133	155	SAROT	S-67N	15		SS-55	269		USG-15/16ET	262	GRACEY
PH-134	155	SAROT	S-67R	15		SS-56	269		USG-17/18S	264	GRACEY
PH-140	146	RYDER	S-80	16	FELSCH	SS-58	269		USG-KN1/26	264	KRAMER-NEVINS
PH-141	146	RYDER	S-97	16		SS-60M	215		USS-5/6LAN	264	LANGER
PH-142	146	RYDER	S-97B	16		SS-61M	215		USS-5/33	265	JACQUETTE
PL-1	254	LUKS	S-351S	17		SS-62M	215		USS-15/30	265	TOWNER-JACQUETTE
PL-2	254	LUKS	S-400	38		SS-64M	215		USS-15/33	265	TOWNER-JACQUETTE
PL-3	254	LUKS	SC-1	108	SPENCER	SS-65	214,270		USS-204S	265	
PL-4	254	LUKS	SC-2	108	SPENCER	STF-1	260		USS-H6/7	265	
PM-1	282		SC-5	108	SPENCER	STF-1R	260		USS-J14/15	265	JACQUETTE
PM-2	282		SC-9	108	SPENCER	TASO-1	230	TASO	USS-KRA1	264	KRAMER
PM-3	282		SC-13	108	SPENCER	TASO-2	230	TASO	USS-KRA3	264	KRAMER
PM-4	282		SC-14	108	SPENCER	TASO-3	230	TASO	USS-MC11/12	264	McCALL
PM-5	282		SC-15	108	LITTAUER	TASO-4	230	TASO	USS-MC13/14	264	McCALL
PM-6	282		SC-16	108	KELLY	TASO-5	230	TASO	USS-MC13/14S	264	McCALL
PO-37	159	CRILE	SD-1	260		TASO-6	230	TASO	USS-MC17/18S	264	McCALL
PO-38	159	TÖNNIS	SD-2	260		TASO-7	130	TASO	USS-NV0	265	NEVI
PO-40	160		SD-3	260		TASO-8	230	TASO	USS-NV11/12	265	NEVI
PO-45	161	MATHIEU	SD-3R	260		TASO-9	130	TASO	USS-NV13/14	265	NEVI
PO-46	160	MATHIEU	SD-7	259		TG-10	199	FREER	USS-T2/3	265	TAYLOR
PO-47	160	MATHIEU	SD-7R	259		TG-11	199	FREER	USS-YG7/8	206	YOUNGER-GOOD
PO-48	160	MATHIEU	SD-8	259		TG-12	199	FREER	UST-1/2MS	206	ORBAN
PO-50	158	MATHIEU	SD-8M	259		TG-15	200		UST-1/2ML	206	ORBAN
PO-51	158		SD-8NA	259		TG-20	199	FREER	UST-KPA	206	
PO-52	158	MATHIEU	SD-8W	259		TG-21	199	FREER	UST-MP	206	
PO-55	158	BOYNTON	SD-8WM	259		TG-22	199	FREER	UST-MPA	206	
PO-56	158	BOYNTON	SD-9NA	259		TG-23	199	FREER	WEST	223	WEST
PO-59	150	GILLIES	SD-88	259		TG-30	200		WG-10	223	WILLIGER
PO-60	161	MATHIEU	SD-88M	259		TG-31	200		WG-12	223	WILLIGER
PO-61	161	MATHIEU	SD-20	259		TG-32	200		WG-14	223	WILLIGER
PO-65	160	MATHIEU	SD-20M	259		TS-1	283	BLACK			
PO-68	161	SMAHA	SD-M	72		TS-2	283	BLACK			
PO-69	161	SMAHA	SE-2	58	SELDIN	TS-3	283	BLACK			
PO-71	161	MATHIEU	SE-4L	58	SELDIN	TS-4	283	BLACK			
PO-76	161	SMAHA	SE-4R	58	SELDIN	TS-40	214				
PO-77	161	SMAHA	SL-1	231		TT-01	118	COLLEGE			
PO-78	160	MATHIEU	SL-2	231		T-USG-1/2	266	GRACEY			
PO-79	160	MATHIEU	SL-21	233		T-USG-5/6	266	GRACEY			
PO-80	160	MATHIEU	SM-1	253	WILLIAMS	T-USG-7/8	266	GRACEY			
PO-81	160	MATHIEU	SM-2	253	MERRIT	T-USG-11/12	266	GRACEY			
PO-82	158	MATHIEU	SM-3	253	MERRIT	T-USG-13/14	266	GRACEY			
PO-84	158	MATHIEU	SM-4	253	GOLDMAN-FOX	T-USS-YG7/8	266	YOUNGER-GOOD			
PO-85	158	ARRUGA	SM-5	253	UNIV. MICHIGAN	T-USS-B5/6	266	BARNHART			
PO-86	158	LICHTENBERG	SM-6	253		USB-P2	216				
PO-87	158	ARRUGA	SM-11	251		USB-P3	216				
PO-88	158	BOYNTON	SM-12	251		USB-P4	216				
PO-94	158	BOYNTON	SM-13	251		USB-P1	216				
PO-99	157	GILLIES	SM-15	251		USB-P3Z	216				
PO-99L	157	GILLIES	SM-19	251		USB-P1Z	216				
PO-104	157	FOSTER-GILLIES	SM-20	252	CATTONI	USB-P2Z	216				
PO-105	157	FOSTER-GILLIES	SM-21	251	WHO	USB-P4Z	216				
PR-3	226	PRICHARD	SM-22	252	NABERS	USC-2	276	COLUMBIA			
PR-3A	226	PRICHARD	SO-1	249		USC-2RL	264	COLUMBIA			
PZ-1	254		SO-2	249		USC-4RL	264	COLUMBIA			
PZ-2	254		SO-3	249		USC-13/14	264	COLUMBIA			
PZ-3	254		SO-4	249		USG-1/2	263	GRACEY			
PZ-4	254		SO-5	249		USG-1/2ET	262	GRACEY			
R-1	275	HOLLENBACH	SO-6	249		USG-1/2L	264	GRACEY			
R-2	275	HOLLENBACH	SO-7	250		USG-1/2S	263	GRACEY			
R-3	275	HOLLENBACH	SO-8	250		USG-3/4	263	GRACEY			
RH-4	257		SO-9	250		USG-3/4ET	262	GRACEY			
RH-4A	257		SO-10	250		USG-3/4L	264	GRACEY			
RH-5	257		SO-11	250		USG-3/4S	263	GRACEY			
RH-5A	257		SO-12	250		USG-5/6	263	GRACEY			
RH-14	257		SO-20	252		USG-5/6ET	262	GRACEY			
RH-15A	257		SP-1	255		USG-5/6L	264	GRACEY			
RO-1	39		SP-2	255		USG-5/6S	263	GRACEY			
S-0	274		SP-3	255		USG-7/8	263	GRACEY			
S-00	274		SP-4	255		USG-7/8ET	262	GRACEY			
S-1	274		SP-5	255		USG-7/8L	264	GRACEY			
S-2	274		SP-6	255		USG-7/8S	263	GRACEY			
S-3	274		SP-7	255		USG-9/10	263	GRACEY			
S-3AN	13		SR	274		USG-9/10ET	262	GRACEY			
S-4	274		SS-15	270		USG-9/10L	264	GRACEY			
S-7	13		SS-16	270		USG-9/10S	263	GRACEY			
S-31	14		SS-20	216		USG-11/12	263	GRACEY			
S-34	13		SS-21	216		USG-11/12ET	262	GRACEY			
S-35	13		SS-22	216		USG-11/12L	264	GRACEY			
S-49	17		SS-41	270		USG-11/12S	263	GRACEY			



Pakistan

Address: Rangpura, Rang Mahal Street, Sialkot (51310) Pakistan.

E-mail: mail@advilcorp.com

Contact: +965-41046118

Kuwait

Address: Abraq Khaitan, Block 6 St 55, Kuwait